



US Army Corps
of Engineers
Construction Engineering
Research Laboratories

USACERL Technical Report 98/33
January 1998

CONSTRUCTION PRODUCTIVITY ADVANCEMENT RESEARCH (CPAR) PROGRAM

Demonstration of Advanced Composite Cables for Prestressing Applications in Concrete Waterfront Structures

by

Srinivasa L. Iyer and Richard G. Lampo

Approved for public release; distribution is unlimited.

19980305 043

DTIC QUALITY INSPECTED 2

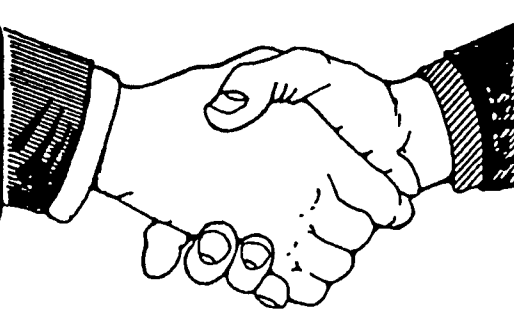
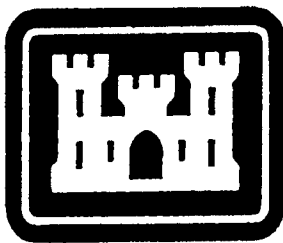

*A Corps/Industry Partnership To Advance
Construction Productivity and Reduce Costs*

The contents of this report are not to be used for advertising, publication, or promotional purposes. Citation of trade names does not constitute an official endorsement or approval of the use of such commercial products. The findings of this report are not to be construed as an official Department of the Army position, unless so designated by other authorized documents.

DESTROY THIS REPORT WHEN IT IS NO LONGER NEEDED

DO NOT RETURN IT TO THE ORIGINATOR

USER EVALUATION OF REPORT

REFERENCE: USACERL Technical Report 98/33, *Demonstration of Advanced Composite Cables for Prestressing Applications in Concrete Waterfront Structures*

Please take a few minutes to answer the questions below, tear out this sheet, and return it to USACERL. As user of this report, your customer comments will provide USACERL with information essential for improving future reports.

1. Does this report satisfy a need? (Comment on purpose, related project, or other area of interest for which report will be used.)

2. How, specifically, is the report being used? (Information source, design data or procedure, management procedure, source of ideas, etc.)

3. Has the information in this report led to any quantitative savings as far as manhours/contract dollars saved, operating costs avoided, efficiencies achieved, etc.? If so, please elaborate.

4. What is your evaluation of this report in the following areas?

a. Presentation: _____

b. Completeness: _____

c. Easy to Understand: _____

d. Easy to Implement: _____

e. Adequate Reference Material: _____

f. Relates to Area of Interest: _____

g. Did the report meet your expectations? _____

h. Does the report raise unanswered questions? _____

i. General Comments. (Indicate what you think should be changed to make this report and future reports of this type more responsive to your needs, more usable, improve readability, etc.)

5. If you would like to be contacted by the personnel who prepared this report to raise specific questions or discuss the topic, please fill in the following information.

Name: _____

Telephone Number: _____

Organization Address: _____

6. Please mail the completed form to:

Department of the Army
CONSTRUCTION ENGINEERING RESEARCH LABORATORIES
ATTN: CECER-TR-I
P.O. Box 9005
Champaign, IL 61826-9005

REPORT DOCUMENTATION PAGE

Form Approved
OMB No. 0704-0188

Public reporting burden for this collection of information is estimated to average 1 hour per response, including the time for reviewing instructions, searching existing data sources, gathering and maintaining the data needed, and completing and reviewing the collection of information. Send comments regarding this burden estimate or any other aspect of this collection of information, including suggestions for reducing this burden, to Washington Headquarters Services, Directorate for Information Operations and Reports, 1215 Jefferson Davis Highway, Suite 1204, Arlington, VA 22202-4302, and to the Office of Management and Budget, Paperwork Reduction Project (0704-0188), Washington, DC 20503.

1. AGENCY USE ONLY (Leave Blank)	2. REPORT DATE January 1998	3. REPORT TYPE AND DATES COVERED Final	
4. TITLE AND SUBTITLE Demonstration of Advanced Composite Cables for Prestressing Applications in Concrete Waterfront Structures		5. FUNDING NUMBERS CPAR 3L2	
6. AUTHOR(S) Srinivasa L. Iyer and Richard G. Lampo			
7. PERFORMING ORGANIZATION NAME(S) AND ADDRESS(ES) U.S. Army Construction Engineering Research Laboratories (USACERL) P.O. Box 9005 Champaign, IL 61826-9005		8. PERFORMING ORGANIZATION REPORT NUMBER TR 98/33	
9. SPONSORING / MONITORING AGENCY NAME(S) AND ADDRESS(ES) Headquarters, U.S. Army Corps of Engineers ATTN: CEMP-CE 20 Massachusetts Ave. NW Washington, DC 20314-1000		10. SPONSORING / MONITORING AGENCY REPORT NUMBER	
11. SUPPLEMENTARY NOTES Copies are available from the National Technical Information Service, 5285 Port Royal Road, Springfield, VA 22161.			
12a. DISTRIBUTION / AVAILABILITY STATEMENT Approved for public release; distribution is unlimited.		12b. DISTRIBUTION CODE	
13. ABSTRACT (Maximum 200 words) <p>Corrosion of steel reinforced concrete in waterfront structures is a serious and costly infrastructure problem. Advanced composite materials such as glass fiber reinforced polymers (GFRP) and carbon fiber reinforced polymers (CFRP) do not corrode, and are attractive potential replacements for steel reinforcement and prestressing materials. The objective of this research was to demonstrate the satisfactory performance and overall economy of using advanced composites as prestressing cables in concrete construction for Civil Works-type structures in corrosive environments. Piles, a deck slab, and pile caps using advanced composite prestressing cables were designed, constructed, and tested for a demonstration pier at Port Hueneme, CA.</p> <p>The composite prestressing system used in the pier met or exceeded all applicable standards for steel-prestressed concrete structures by the American Concrete Institute and the American Association of State Highway Transportation Officers. Fabrication of the pier components required only minor procedural changes and quality control was fully effective. Composite cables cost more than steel cables, but the cost for prestressing materials represents only a small portion of total construction costs, and long-term durability of the composite materials is expected to reduce overall life-cycle costs in corrosive environments.</p>			
14. SUBJECT TERMS CPAR fiber reinforced concrete corrosion control		concrete testing	15. NUMBER OF PAGES 104
			16. PRICE CODE
17. SECURITY CLASSIFICATION OF REPORT Unclassified	18. SECURITY CLASSIFICATION OF THIS PAGE Unclassified	19. SECURITY CLASSIFICATION OF ABSTRACT Unclassified	20. LIMITATION OF ABSTRACT SAR

Foreword

This study was conducted for Headquarters, U.S. Army Corps of Engineers under Construction Productivity Advancement Research (CPAR) Work Unit 3L2, "Demonstration of Advanced Composite Cables for Use as Prestressing in Concrete Waterfront Structures." The technical monitors were J. Hartman, CECW-ED, and S. Green, CEMP-CE.

The work was coordinated and performed through a Cooperative Research and Development Agreement (CPAR-CRDA) between:

- the Materials Science and Technology Division (FL-M) of the Facilities Technology Laboratory (FL), U.S. Army Construction Engineering Research Laboratories (USACERL), the Corps laboratory partner, and
- the South Dakota School of Mines and Technology (SDSM&T), 501 East St. Joseph Street, Rapid City, SD, the industry/academic partner.

CPAR partner participants included Amoco Performance Products, Atlanta, GA; Owens-Corning Fiberglass Corporation, Granville, OH; Neptco, Inc., Pawtucket, RI; and the Composites Institute, a Division of the Society of the Plastics Industry, New York, NY. The U.S. Naval Facilities Engineering Service Center (NFESC), Port Hueneme, CA, was a laboratory participant in this project. A special thanks to the many individuals, too numerous to list, from the participating organizations who helped make this project a success.

The USACERL Principal Investigator was Richard G. Lampo, CECER-FL-M, and the SDSM&T Principal Investigator was Srinivasa L. Iyer. Dr. Ilker R. Adiguzel is Acting Chief, CECER-FL-M, and L. Michael Golish is Acting Operations Chief, CECER-FL. The USACERL technical editor was Gordon L. Cohen, Technical Information Team.

COL James A. Walter is Commander of USACERL, and Dr. Michael J. O'Connor is Director.

Contents

SF 298	1
Foreword	2
List of Figures and Tables	5
1 Introduction	9
Background	9
Objectives	10
Approach	10
Metric Conversion Factors	10
2 Site Selection and Design Requirements	11
Site Selection	11
Design Requirements	11
3 Materials and Methods of Prestressing	14
Pre-Tensioning and Post-Tensioning	14
Anchorage	14
Choice of Prestressing Materials	15
Spirals	16
4 Design and Construction of Piles	18
Design of Piles for Handling Stresses	18
Driving the Test Pile	19
Construction of Piles	21
Removal and Shipment	23
5 Design and Construction of Deck Slab	33
Preliminary Deck Slab Design	33
Prestressing Frame	34
Prestressing Frame Test and Verification of Losses	35
Cables And Anchorages	36
Formwork	37
Pre-Tensioning of Deck Slabs 1 and 2	37
Placement of Concrete	39
Curing of Concrete	39
Destressing Operation	40

Quality Assurance	40
Laboratory Testing of Deck Slab 2	40
6 Design and Construction of Pile Caps	51
Pile Cap Specifications	51
Construction of Pile Caps	53
Safety Precautions	56
7 Pier Construction and Testing	57
Structural Performance Testing	57
8 Design and Construction Guidelines	65
Design Philosophy	65
Mechanical Properties of Cables	65
Development of Anchorages	66
Design Guidelines	66
Construction Guidelines	66
Cost of Different Cables	68
9 Conclusions, Recommendations, and Commercialization	74
Conclusions	74
Recommendations	75
Commercialization and Technology Transfer	76
References	78
Appendix A: Construction Productivity Advancement Research (CPAR) Program ..	80
Appendix B: Literature Survey of Related Work	81
Appendix C: Design of Piles	84
Appendix D: Design of Deck Slab	87
Appendix E: Design of Pile Caps	95

Distribution

List of Figures and Tables

Figures

1	Diagram of the CPAR demonstration pier construction	13
2	Winding carbon spirals over the frame	17
3	Longitudinal and cross section of pile	24
4	Test pile positioned for driving	25
5	Test pile driving in progress	25
6	CFRP cables uncoiled and ready for placement	26
7	CFRP cables and carbon spirals for the pile	26
8	Conventional chucks at the dead end	27
9	Threaded rods at the jacking end	28
10	CFRP cables with 50 ft lb of torque for uniform tension before jacking	29
11	CFRP spirals spread at required pitch	29
12	Eight CFRP cables being stressed with a jack	30
13	Conventional needle vibrators used to consolidate the concrete	31
14	Strain gages on the CRFP cables	32
15	Cross sectional view of cross girder	42
16	Cross sectional view of longitudinal girder	42
17	CFRP cables stressed and ready for placing concrete	43

18	Details of spirals near the corners of deck slab	44
19	Tube anchorage and threaded rods on jacking end	44
20	Conventional chucks at the dead end	45
21	Layout of cables in deck slab	46
22	Stressing of top eight cables in progress	47
23	Vertical plastic ducts in Deck 2 to facilitate load tests	47
24	Concreting of deck slab in progress	48
25	Top layer of distribution reinforcement (CFRP cable) being placed after 15 inches of concreting	48
26	Hydraulic jack setup for loading deck slab 2	49
27	General setup for loading the deck slab 2	50
28	Dial gages for measuring deflection during testing deck 2	50
29	Cross-section of a pile cap	58
30	Ducts projecting outside the formwork and PVC tubes extending above the finished concrete surface	58
31	Side and end forms removed after concrete attained 4000 psi strength	59
32	Tube anchorage on jacking end of GFRP cables	59
33	Inserting GFRP cables in the ducts	60
34	Two cables at a time pulled by the hydraulic	60
35	Air pressure used to pump grout into the ducts	61
36	Stressing of cables in progress	61
37	Piles being jetted into position prior to driving	62

38	Deck slab being hoisted into place onto the pile caps	62
39	Overall view of the completed pier structure	63
40	Falling weight deflectometer used in structural performance tests on the pier deck	63
41	FWD test results, November 1994	64
42	Stress relaxation test on E-glass/GFRP cables	71
43	Stress relaxation test on CFRP cables	71
D.1	Deck slab cross section	88
D.2	Shear diagram	92

Tables

1	Summary of losses in the cables (Vedati 1994)	17
2	Mechanical properties of cables (Gorty and Vedati 1994)	17
3	Summary of long-term losses	42
4	Summary of losses	58
5	Mechanical properties of FRP composite cables	71
6	Summary of design parameters for various cables	72
7	Transfer and development lengths	73

1 Introduction

Background

Corrosion-related deterioration of steel reinforced concrete in waterfront structures is a very serious infrastructure problem and costs the nation billions of dollars. Visible signs of corrosion can be observed in less than 12 months after construction in waterfront environments. Advanced composite materials such as glass fiber reinforced polymers (GFRP) and carbon fiber reinforced polymers (CFRP) do not corrode, and are attractive potential replacements for steel. Cables made of these materials have a very high tensile strength and possibly could replace steel cables for prestressing operations. The main barrier to developing composite prestressing cables is the difficulty of anchoring these materials. An anchorage system was developed at South Dakota School of Mines and Technology (SDSM&T) to hold these composite cables (Iyer 1988), and was further refined in later projects. This anchorage system was used in the nation's first prestressed bridge deck using advanced composite cables, built in 1991 in Rapid City, SD. Even though this technology is available, the U.S. construction industry still lacks full knowledge of its benefits, and consequently the industry has not developed confidence in these products for common field applications.

To more visibly demonstrate the benefits of this technology and to promote technology transfer and commercialization, SDSM&T submitted a proposal to the U.S. Army Corps of Engineers Construction Productivity Advancement Research (CPAR) Program to demonstrate the use of advanced composite cables for prestressing concrete in waterfront structures subject to corrosion damage (Appendix A gives further information on the CPAR Program). This CPAR project, executed in partnership with the U.S. Army Construction Engineering Research Laboratories, demonstrated the use of fiber reinforced plastic (FRP) composite cables for prestressing concrete. In addition to USACERL and SDSM&T, several other organizations worked on the project as CPAR "partner participants." They were: Amoco Performance Products, Atlanta, GA; Owens-Corning Fiberglass Corporation, Granville, OH; Neptco, Inc., Pawtucket, RI; and the Composites Institute, a Division of the Society of the Plastics Industry, New York, NY. The U.S. Naval Facilities Engineering Service Center (NFESC), Port Hueneme, CA was a laboratory participant in this project.

Objectives

The objective of this project was to demonstrate the satisfactory performance and overall economy of using advanced composites as prestressing cables in concrete construction for Civil Works-type structures in corrosive environments (e.g., splash zone areas, marine/salt water exposures, water immersion, etc.). Material specifications and design and construction guidance for the use of these advanced composite cables as prestressing for concrete structures in corrosive environments will also be developed.

Approach

A literature search was conducted to identify previous research findings of relevance (Appendix B). The construction site—a test pier at Port Hueneme, CA—was selected in cooperation with NFESC. Survey information was collected on the soil and other conditions at the test site. NFESC coordinated gathering site information and preparation. A two-bay pier structure was then designed using FRP composite prestressing cables as the reinforcing elements for the concrete.

The prestressing cables were fabricated and tested to assure quality. The concrete piles and deck slabs were then cast and tested for quality before delivery to the construction site. The piles were driven into place and pile caps fabricated on site. After completing the pile caps, the deck slabs were installed. The pier was then structurally tested using a falling weight deflectometer. A year later pier construction was retested to determine if any deterioration in structural capacity had occurred.

Metric Conversion Factors

This report uses U.S. standard units of weight and measure. A list of conversion factors for standard international (SI) units is provided below.

$$1 \text{ ft} = 0.305 \text{ m}$$

$$1 \text{ lb} = 0.453 \text{ kg}$$

$$1 \text{ sq in.} = 6.45 \times 10^{-4} \text{ m}^2$$

$$1 \text{ in. lb} = 0.1130 \text{ N m}$$

$$1 \text{ psi} = 6.895 \text{ kPa}$$

$$1 \text{ plf} = 14.59 \text{ N/m}$$

$$1 \text{ lbf} = 4.448 \text{ N}$$

2 Site Selection and Design Requirements

Site Selection

The original plans were to design and construct a pier structure using standard AASHTO* bridge requirements. However, due to the mutual interest in FRP composite materials, NFESC offered demonstration space within a section of its Advanced Waterfront Technology Test Site (AWTTS). NFESC was constructing the AWTTS to study advanced material technologies such as FRP composites for pier construction and rehabilitation.

Port Hueneme is a deep-water port located north of Los Angeles, CA, and home to the NFESC. The Navy researchers had been using a wooden test pier for testing different materials in a marine environment. The wooden test pier was removed and the new AWTTS was constructed in its place. The new test facility is 160 ft long comprising two full-size bays of 20 ft spans, with the rest comprising half-scale bays. The two full-scale bays were made available to this CPAR project. Figure 1 shows the details of two bays, with CFRP prestressed concrete deck as one bay and an all-composite deck as the other. (The all-composite deck was not a direct part of this CPAR project and therefore not described further. Details about the deck may be found in the literature [Randazzo 1994].)

Design Requirements

Because NFESC was making part of its own facility available for this study, the Principal Investigators asked NFESC personnel to provide their requirements for a typical Navy pier structure. Based on the footprint of their modern heavy cranes, the pier structure and deck must be able to support a dead load of 225 kips** distributed over a 30 in. square area.

The load distribution was studied for a concentrated load up to 225,000 lb distributed over an area of 30 in. square on the deck slab (Ranganathan 1994). This

* AASHTO: American Association of State Highway and Transportation Officers.
** kips: kilopounds

verified the results of an earlier study conducted by the Navy on flat slabs to design the crane outrigger loads (Warren and Malvar 1991). The results agreed with the results of the earlier study of load distribution equal to half the span. Ramabhadran tested the deck slab in the laboratory for deflection and load distribution. The pilings and pilecap design and construction for the Port Hueneme CPAR project were also investigated (Sivakumar 1995).

Piles

The piles were designed as friction piles based on the soil data obtained from the NFESC. The piles had to be designed for the worst position of 225 kips load placed directly on the pile. The length and the dimensions of the pile were calculated from the soil data and the bearing capacity of the pile on the basis of friction between soil and pile. A tentative size of the pile had been worked out as 14 in. square with 40 to 45 ft penetration into the soil, and 15 ft projection to the required level of pile top (total length 60 ft). Details of the pile design are shown in Appendix C.

Pile Caps

The 225 kip load was placed at the center of the deck slab for testing, so the pilecaps were designed for half of that load. The 2.25 ft overhang on the three-span continuous beam created the most critical bending and shear, and the section was designed for those values. A bonded post-tension method with GFRP composite cables was used for pilecaps. Details of the design are shown in Appendix D.

Deck Slab

The concrete deck slab was designed for a load of 225 kips distributed on a 30 in. square area to support modern maritime cranes. The overall dimensions of the deck slab were 18 ft x 20 ft x 1.5 ft. It was decided to cast the slab in two sections of 9 ft x 20 ft for the ease of transportation. The pretensioning method of prestressing was used with the CFRP composite cables and the self-straining frame for holding the cables. One end of the carbon cable was anchored using conventional anchorage while the other end was anchored using tube anchorage in order to reduce the transfer losses. Five-thousand psi concrete with Type III cement was used for the deck slab. The details of the design are shown in Appendix E. Losses in prestressing were computed based on both AASHTO and American Concrete Institute (ACI) specifications; the maximum of the two was used for the design.

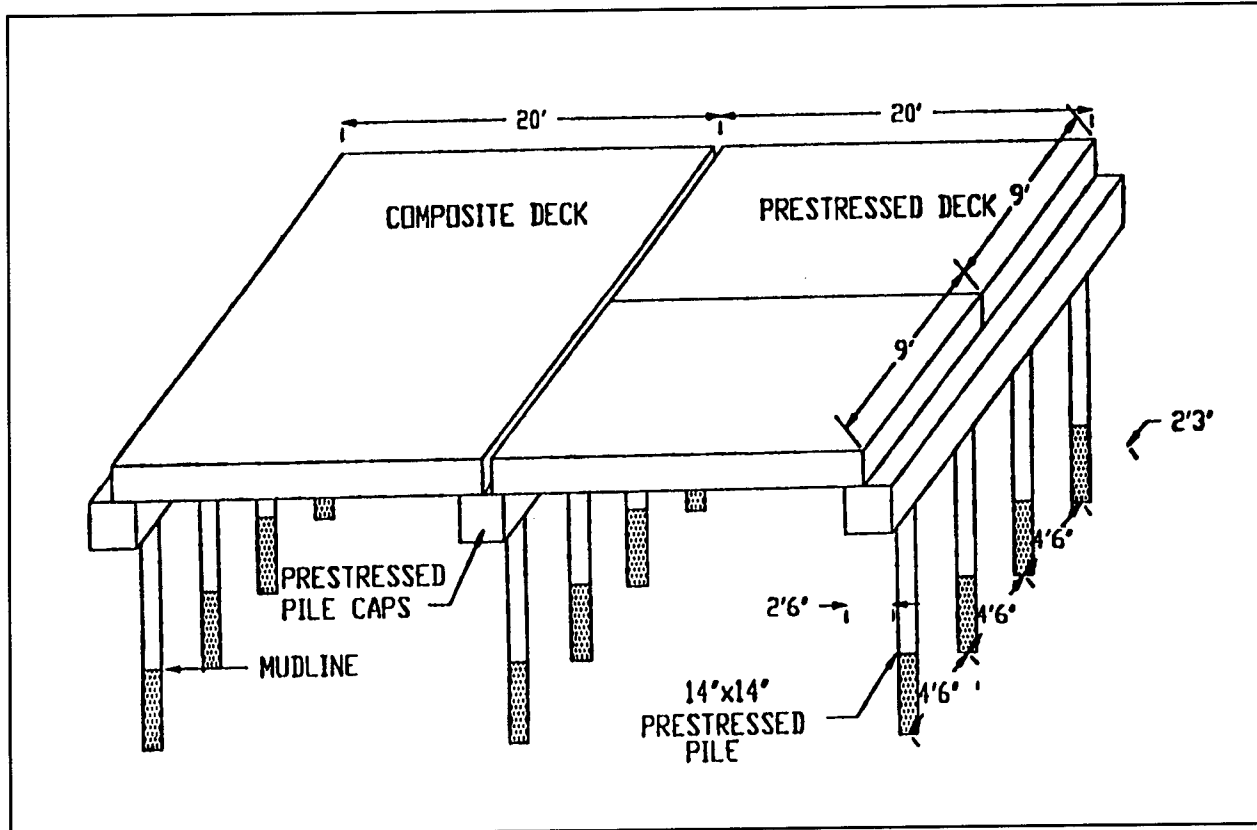

Figure 1. Diagram of the CPAR demonstration pier construction.

3 Materials and Methods of Prestressing

Pre-Tensioning and Post-Tensioning

Tensile stresses in conventional reinforced concrete produces cracks, and these cracks are the major source of concrete deterioration over time. Prestressed concrete keeps the entire section in compression (i.e., no tension) and therefore reduces the chances of deterioration due to concrete cracking and subsequent corrosion of reinforcement tendons. Consequently, prestressing with nonmetallic cables addresses both the cracking and corrosion problems.

Two methods are used in prestressing—pre-tensioning and post-tensioning. In pre-tensioning, the prestressing tendons are loaded and temporarily held against a rigid frame or an abutment, concrete is then placed in forms and allowed to cure until the concrete attains the required strength to transfer the force. The tendons are then cut to release the prestressing force and transfer the force to concrete by the bond between the tendon and concrete.

In post-tensioning, ducts for the prestressing cables are placed in the mold and concrete is poured. After the concrete has reached the required strength, the tendons are inserted through the ducts, tensioned by means of a jack, and anchored at the ends to maintain the stress in the cable. This method is known as unbonded post-tensioning. Sometimes after stressing the tendons, the ducts are filled with grout so the end anchorages can be removed. In this case the force in the tendons is transferred to the concrete by the bond between the tendons and duct through the grout. This is the method developed by SDSM&T that was used in the construction of the prestressed concrete bridge deck in 1991 (see Chapter 1 and Appendix B).

Anchorage

A conventional anchorage system for composite cables was previously developed at SDSM&T (Iyer 1988). The conventional anchorage system basically strengthens composite cables at the ends and uses two standard 0.6 in. diameter steel chucks (normally used with steel cables) to hold the cables in tension. A bridge deck was built at Rapid City, SD, using the bonded post-tensioning method (Iyer 1991). The

transfer losses for this 17 ft length in prestressing were reported to be very high. CFRP cables incurred a loss of 25 percent, while GFRP and steel cables incurred a loss of 15 percent and 30 percent respectively. All these transfer losses were in proportion to the moduli of these materials. A new tube anchorage was developed at SDSM&T for the current CPAR project. A combination of conventional anchorage at the dead end and tube anchorage at the live end significantly reduced the transfer and anchorage losses, as shown in Table 1 (Vedati 1994). The tube anchorage used threaded rods and nuts to hold the force, and therefore fine adjustments in prestressing force were possible with this anchorage. In case a cable failed during prestressing, chucks on the conventional anchorage would shoot like a bullet, whereas the tube anchorage would be restricted within the prestressing bed. Thus the tube anchorage was confined within the prestressing bed which is safer in the event of a cable failure.

Choice of Prestressing Materials

For prestressing operation, the cable should have high tensile strength and minimal creep loss under sustained load. Both CFRP and GFRP cables satisfied these requirements, as evident from previous experience (Vedati 1994). Table 2 shows the mechanical properties of GFRP, CFRP, and steel cables. The GFRP and CFRP cables have the advantage of being noncorrosive in a marine environment, so they were a logical choice for prestressing cables for waterfront structures. However, the selection of prestressing method and the choice of cable material varied for different elements of this structure.

Transfer and chuck losses were very important for short-length prestressing. These losses were studied to develop the tube anchorage to reduce the losses as shown in Table 1.

Piles

Piles are normally made using the pre-tensioned method of prestressing at a precast plant. In the pre-tensioning method, the cables are in direct contact with concrete, which has a high alkaline value. GFRP cables may have a long-term reaction with concrete and should not be used at high stress levels for pretensioning, even though they are more economical. CFRP cables can be used at higher stress levels than glass when in direct contact with concrete, so they were selected for pre-tensioning of the piles. All spirals required for the piles were CFRP.

Pile Caps

Pile caps act as three transverse beams connecting the four piles to support the decking. These three pile caps were cast at the site to ensure proper connection between the piles and the pile caps. CFRP cables were used wherever the reinforcements were in direct contact with concrete, while GFRP cables were used for post-tensioning through the embedded ducts. As described previously, the GFRP cables were stressed after the concrete was cast and cured. This allowed the researchers to exploit the properties and economy of GFRP (using E glass) without exposing the material to the concrete. The non-prestressed reinforcement and shear reinforcement, which were in direct contact with concrete, were made of CFRP composite.

Deck

The overall dimensions of the deck were 20 ft in length and 18 ft in width. This was cast in two sections of 9 ft x 20 ft to facilitate shipping. The effective width of deck slab for transverse load distribution was close to 9 ft, which did not create any problem of load distribution from the heavy concentrated load. The selection of a prestressing method was very difficult in this case because both methods could have provided a viable solution. The pre-tensioning method was selected over post-tensioning for two main reasons:

1. The behavior of a pre-tensioned deck had not been studied in the previous project (Iyer 1991). This prompted the use of pre-tensioning for evaluation of the deck. For the pre-tensioned method, CFRP cables were the obvious choice since the cables would be in direct contact with concrete.
2. The design requirements required a prestressing force of nearly 200,000 lb per foot width, totaling 1.8 million lb for 9 ft width. CFRP cables can carry this force with fewer cables compared to E glass GFRP cables.

Spirals

Nineteen strands of T-300 carbon fiber were hand-impregnated with Shell 815 resin over a 10 in. x 10 in. frame (see Figure 2). The frames were made in such a way that they would pivot on the tube extending from the end. The 19 strands were wound over this frame at the desired pitch. The frame was then set aside on a curing stand for 24 hours, and removed after curing. The spirals were marked and set aside for transportation to the construction site.

Table 1. Summary of losses in the cables (Vedati 1994).

Material	Type of Anchorage	Length of Cable (ft)	Stress Level (% of Ult.)	Transfer Loss (Percent)	Anchorage Loss in 48 Hr. (Percent)
CFRP	Tube & Tube	22	60	0.8	4.0
CFRP	Tube & Tube	26	75	1.9 to 1.2	---
CFRP	Tube & Conventional	27	75	1.9	---
CFRP	Conventional & Conventional	27	75	13.5	19.0
E-Glass/ GFRP	Conventional & Conventional	8	62	2.2	7.0

Table 2. Mechanical properties of cables (Gorty and Vedati 1994).

Material	Ultimate Strength (KSI)	Modulus of Elasticity (MSI)
GFRP(E glass)	195	7.7
CFRP	270-294	21.0
Steel	270	29.0

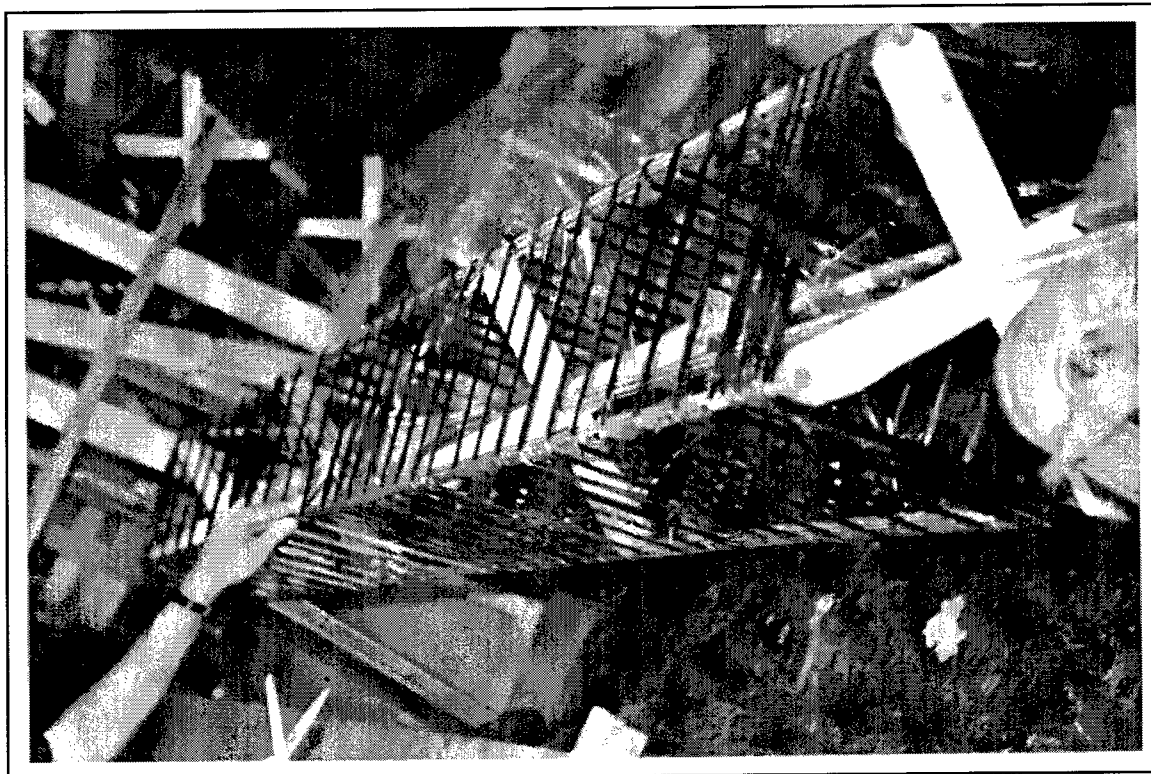

Figure 2. Winding carbon spirals over the frame.

4 Design and Construction of Piles

Design of Piles for Handling Stresses

General

The piles were made in Rapid City, SD, at the South Dakota Concrete Products Plant facilities. As previously noted, pile dimensions were 14 in. x 14 in. x 60 ft. The test pile was made at the plant by SDSM&T students and faculty, and tested by a consultant. South Dakota Concrete Products personnel assumed the responsibility for making the rest of the piles after successful testing of the test pile. Company personnel were trained and assisted throughout the production of all of the remaining piles.

All of the reinforcement was made at the Advanced Composite Laboratory at SDSM&T, then transported to the prestressing plant. Standard steel forms were used. The reinforcements were instrumented and placed in the forms. The cables were stressed just before placement of the concrete. After attaining the desired concrete strength, the piles were removed and stored for shipment to Port Hueneme. The construction sequence used for prestressing the piles is also presented in the literature by Valcan 1994.

Eight CFRP cables with CFRP composite spirals were used for the piles. The cross section and longitudinal section of the pile are shown in Figure 3.

Concrete with 5000 psi ultimate compressive strength and Type II cement was used for casting the piles. CFRP cables with an ultimate strength of 270-294 ksi and a modulus of elasticity of 21 msi were used for the piles. Carbon spirals as described above were used. Plastic ties were used to tie the reinforcement into position.

Checking Handling Stresses

The handling stresses were checked for a two point lifting at 0.2L from the ends for a 60 ft long pile. The bending moment for this case was approximately $wl^2/47$. The losses were calculated based on ACI 318 and AASHTO specifications. The detailed calculations are shown in Appendix C. A total loss of 16.38 ksi (10.5 percent) was

estimated with ACI specifications, and a loss of 18.8 ksi (12 percent) was estimated using AASHTO specifications. Therefore, a loss value of 18.8 ksi was used for the design. Other specifications are as follows:

Cross section of pile is 14 in. x 14 in., Area of cross section, $A = 196 \text{ in.}^2$

Section Modulus, $S_{xx} = 457.33 \text{ in.}^3$

Weight of pile per foot, $w = 14 \times 14 \times 150 / 144 = 204.2 \text{ lb/ft}$

Lifting the pile at 0.2L from each end gives a bending moment of $wl^2/47$

Bending moment for 60 ft long pile = $204.2 \times (60 \times 12)^2 / (12 \times 47) = 187,690 \text{ in. lb}$

Stresses in pile = $187,690 / 457.33 = \pm 410.4 \text{ psi}$

8 CFRP cables with 20,000 lb each gives a jacking force of 160,000 lb

Initial prestressing force with 2 percent transfer loss (Vedati 1994)

$$= 160,000 \times 0.98 = 156,800 \text{ lb}$$

Initial stress = $156,800 / 196 = 800 \text{ psi.} \leq 800 \text{ psi.}$ (Prestressed Concrete, T. Y. Lin)

Handling Stress+Prestress = 390 psi, 1210 psi (Compression) < 2250 psi (0.45 fc')

Driving the Test Pile

A site for driving the test pile was selected near the city disposal location where the soil was uniform without any boulders or rocks. The main objective of the test pile driving was to demonstrate the performance of the CFRP cable-pretensioned piles during handling and driving operations. The pile driving test was conducted on 2 September 1993. An independent consultant, Gobel, Rausche, Likens and Associates, (GRL), Inc. of Boulder, CO, was hired to evaluate the pile during driving.

Dynamic installation tests were performed on the pile by GRL. Field measurements were processed with a Pile Driving Analyzer™ (PDA) program. The results included evaluation of the pile driving stresses, hammer performance, and active soil resistance at the time of testing. Dynamic analysis of the field-recorded data was also performed using CAPWAP® (Case Pile Wave Analysis Program).

The test pile was installed in a vertical orientation with no protection on the pile tip (see Figures 4 and 5). The initial pile cushion consisted of two sheets of 3/4 in. plywood and four layers of 2x4 lumber with the grain perpendicular to the loading. At a penetration of approximately 16 1/2 ft the pile cushion was replaced with a six-sheet package of 3/4 in. plywood.

The pile driving hammer used was a Kobe K13C single-acting diesel hammer. The hammer was manufactured with a nominal ram weight of 2.87 kips and a

manufacturer's energy rating of 25.4 kip ft at maximum stroke. The hammer cushion material was plywood and oak. The subsurface condition was classified as Belle Fourche shale.

Dynamic measurements were obtained with pairs of accelerometers and strain transducers attached 6 ft from the pile top. Analog signals from the gages were conditioned, digitized, stored, and processed with the PDA program. Selected output from the PDA typically included values such as the measured force and the calculated stress maxima, transferred energy, calculated ram stroke, and a case method calculation of mobilized static capacity. Force and velocity records were viewed on the PDA's graphic screen to evaluate data quality, pile integrity, and aspects of soil resistance. Stored dynamic data and the PDA field results were the basis of laboratory analysis.

CAPWAP[®] uses a rigorous numerical analysis procedure which uses the measured force and velocity data to solve for soil resistance perimeters. The pile is divided into segments of approximately 1m (3.3 ft) in length and soil resistance values are assigned to every second embedded pile element (every 2m, or 6.6 ft) and one extra resistance at the pile toe to model the toe bearing. The soil model for each soil element contains the static resistance represented by an elasto plastic spring with ultimate resistance in a limiting elastic displacement (termed the quake). Soil damping is modeled as a viscous dash-pot with a damping factor that relates the magnitude of the dynamic soil resistance to the pile velocity.

Berger concluded in a separate report that although the hammer performance of the pile driver was below average, the capacity of the pile itself is approximately 3.0 ksi in compression and 600–1000 psi in tension. There was no separation of the concrete and no cracks were noted after more than 7000 blows of the hammer.

Based on the demonstration and the results from the pile driver analysis, the design and performance of the pile were concluded to be satisfactory. Twelve similar piles were produced by the South Dakota Concrete Products under a separate contract that included product liability provisions. SDSM&T personnel trained the workers for the first three piles. The remaining piles were made completely by the company personnel.

Construction of Piles

Prestressing Frame and Verification of Losses

The prestressing frame used for the piles was the standard frame for casting two piles at a time. The bulkhead was made of 3 in. thick steel plates. The width at top of the frame was 14 1/2 in., whereas the width at the bottom was 14 in. This tapering of the form facilitated the removal of piles from the formwork. The length of the frame was 80 ft. An 80 ft CFRP cable with conventional anchorage on one end and the tube anchorage on the other end was tested in the frame to verify the transfer and anchorage loss. The losses were determined to be 2 percent for this length of CFRP cable.

Cable Stressing

A total of 96 CFRP cables were made for 12 piles. Seven rods of 0.156 in. diameter were twisted together to form one cable of 0.5 in. nominal diameter. After all the rods were cut, twisted, and tied together, one end of the cable (the dead end) was provided with the conventional anchorage system, and the jacking end was provided with the newly developed tube anchorage system. They were coiled in 12 ft diameter, tied, and transported to the South Dakota Concrete Products Plant. The cables were untied upon arrival and stretched out for their entire length awaiting placement in the formwork (see Figure 6).

The formwork for the piles was a steel mold with end blocks in the forms at a distance of 80 ft. Each end block contained 8 holes for the cables to pass through in the proper position. Each of the 8 holes was lined with plastic pipe and duct tape to ensure that no sharp edges would damage the cable as it passed through the hole. The formwork was sprayed with wax to ensure easy removal of piles. The lateral spiral reinforcement was placed in the formwork and the cables were passed through the spirals (see Figure 7).

Each cable was anchored on the dead end with 2 conventional steel chucks (see Figure 8). The live end of the cable was 16 in. short of the jacking bulkhead. The threaded rods were passed through the bulkhead and threaded into the coupler on the tube anchorage. Nuts were threaded on the rod and snug-tightened to the bulkhead (see Figure 9). Fifty foot-pounds of torque was applied to each cable using a torque wrench to make them tight and to provide equal stress in each cable before actual stressing. The lateral reinforcement was then spread to the required pitch and retained in place by fastening the spirals to the cables with plastic ties (see Figures 10 and 11).

A hydraulic jack was used for applying the prestressing force to all eight cables simultaneously. The jack and pump were calibrated in the laboratory using a Tinius Olsen Testing machine. To help the jack to stress eight cables at one time, a 12 in. x 12 in. x 2 in. thick end plate was used. The end plate was placed over the eight threaded rods and secured in place with bolts. The jack was placed in between the bulkhead and the end plate to apply the prestressing force (see Figure 12).

All eight cables were pulled by the jack to a total force of 160,000 lb (20,000 lb in each cable). This provided an initial pile stress of 800 psi. After prestressing losses, the final stress in the pile was approximately 704 psi (see Appendix B). The average elongation on each cable was 6 - 5/8 in. This elongation was used throughout the stressing of all of the piles to check the process. After the cables were stressed, the nuts on the threaded rods were turned to snug tight and then tightened with a wrench to reduce the losses. The jack and end plate were then removed.

Safety precautions were developed for the stressing operation. For example, the entire mold was covered with a heavy thermal blanket to stop any fibers from flying and hurting people if a cable failed. At the jacking end, the metal screen was strengthened with 1/2 in. plywood to protect the workers during tightening of the nuts on the threaded rods. The stressing operation was conducted according to standard procedure for applying the force. The jack operator worked the hydraulic controls from a truck protected by steel plates and kept away from the line of the bed.

Casting of Piles

Steel lifting hooks were tied with plastic ties at a distance of 12 ft from each end of the pile. Spirals were tied after the stressing had finished. Employees of the South Dakota Cement Products Plant placed concrete along the length of the pile and vibrated it into place using conventional techniques such as needle vibration (see Figure 13). A thermally insulated blanket was placed over the entire prestressing bed and low-pressure steam was applied beneath the cover. A thermocouple was placed in and near the concrete to record the temperature during curing. The concrete was cured for 18–24 hours until a strength of 4000 psi was achieved by testing the cylinders. The piles were destressed by cutting each cable simultaneously at each end. It was unsafe to attempt to cut all cables on one end before cutting any cables on the other end. A circular grinder saw with metal cutting blade was used to cut the cables. The grinder was attached to a long wooden handle to keep the operator away from flying fibers during the cutting operation.

Removal and Shipment

Moving cranes were used to lift the piles from the molds. Four piles were stacked with 4 X 4 lumber separating them in each row. All the piles were identified and marked at 1 ft intervals to assist in monitoring the progress during pile driving. Strain gages were mounted on the cables and the concrete to collect data during driving (see Figure 14). The piles were transported by truck from Rapid City to Port Hueneme, where they were stacked in the same manner in which they were shipped while awaiting installation.

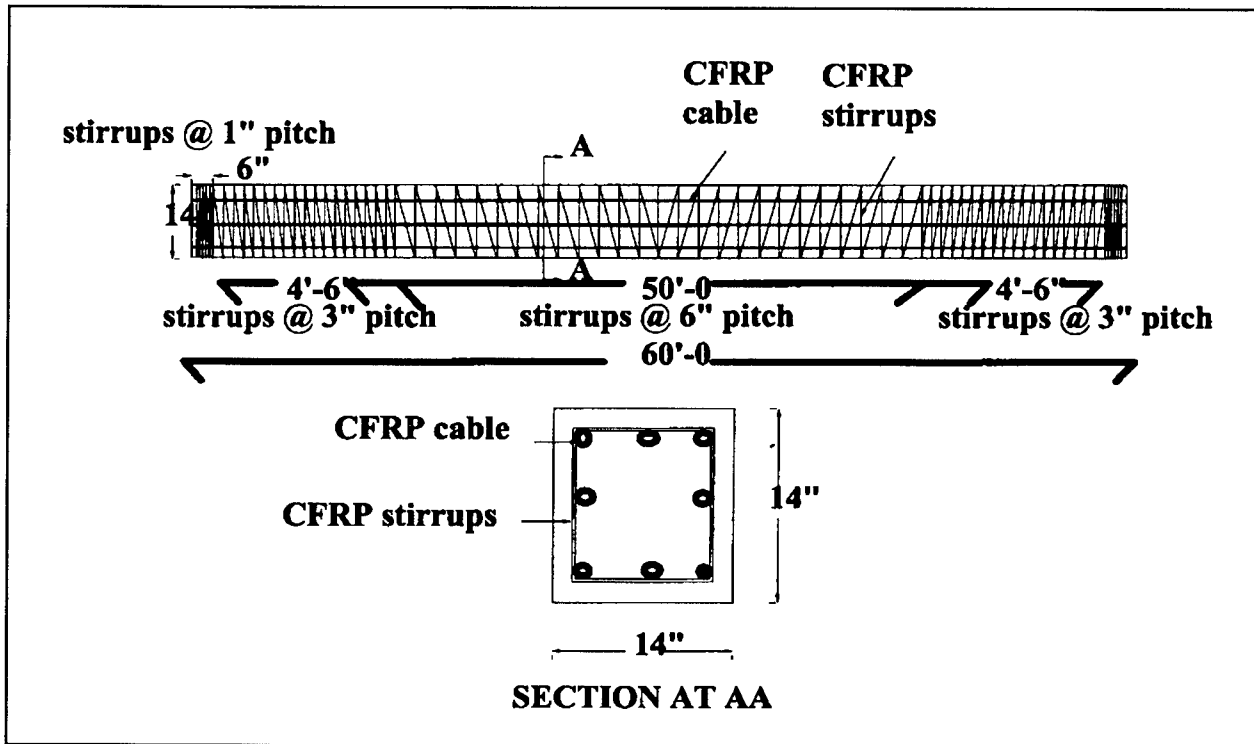

Figure 3. Longitudinal and cross section of pile.

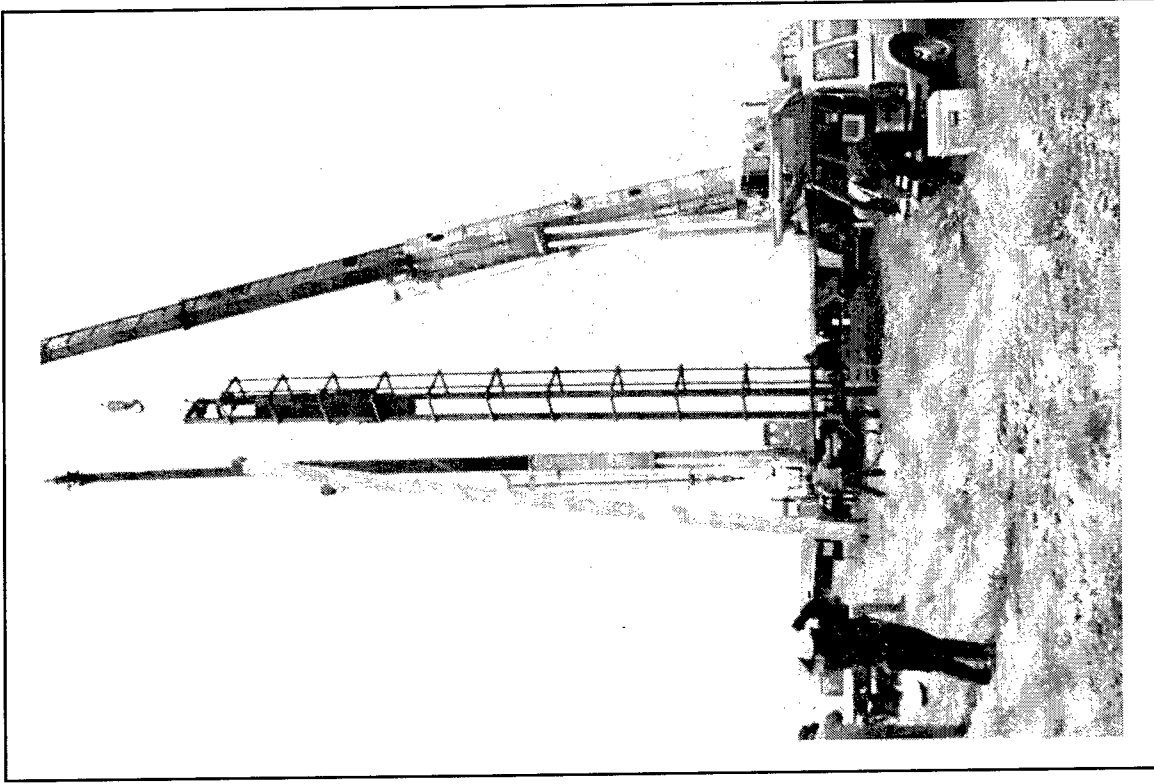

Figure 5. Test pile driving in progress.

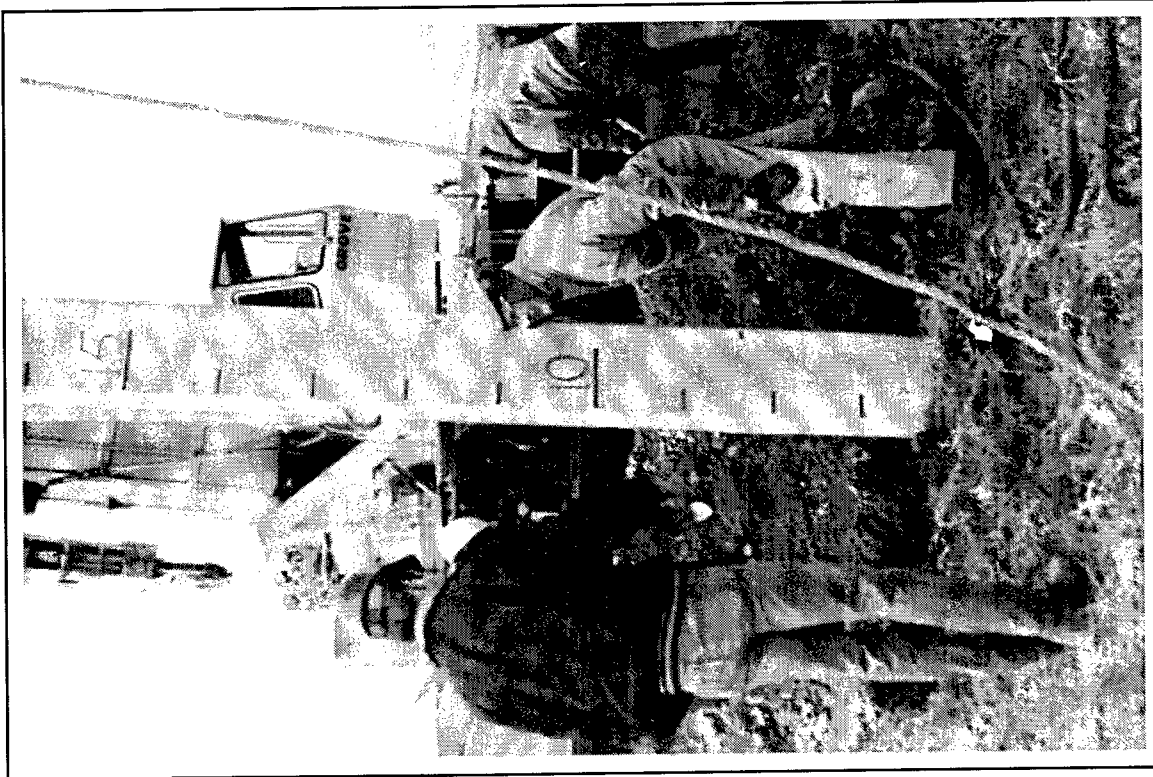

Figure 4. Test pile positioned for driving.

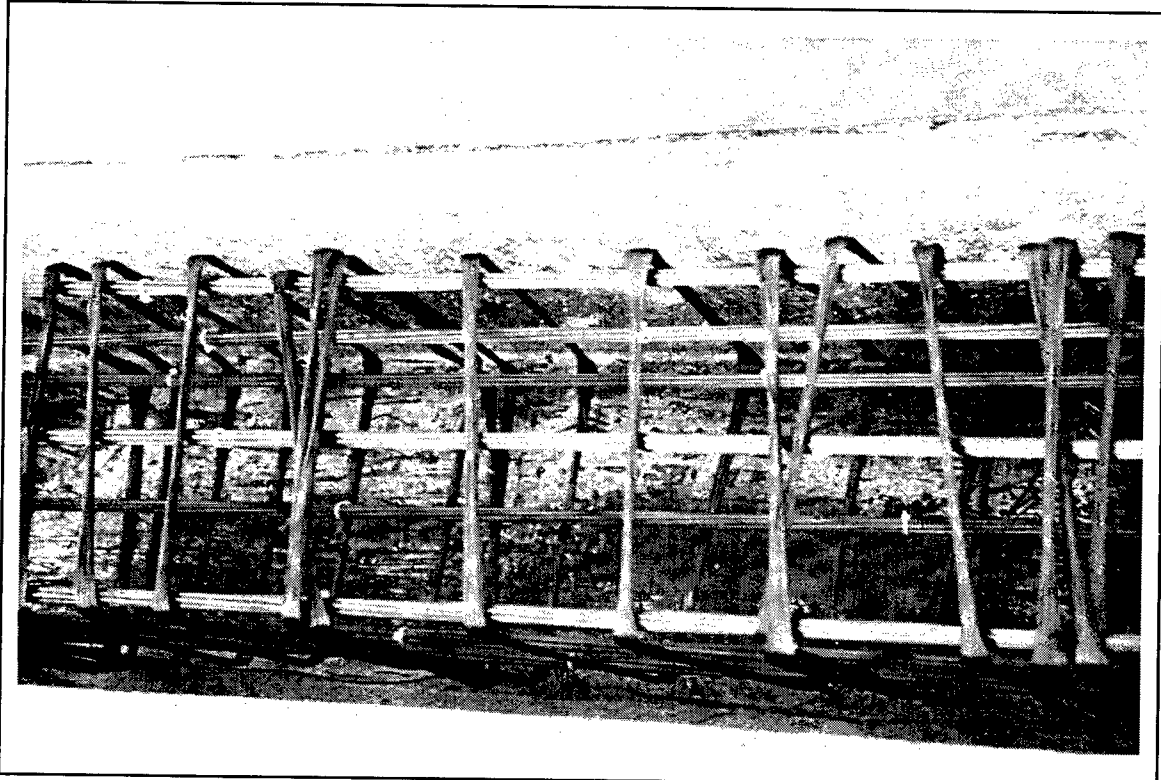

Figure 7. CFRP cables and CFRP spirals for the pile.

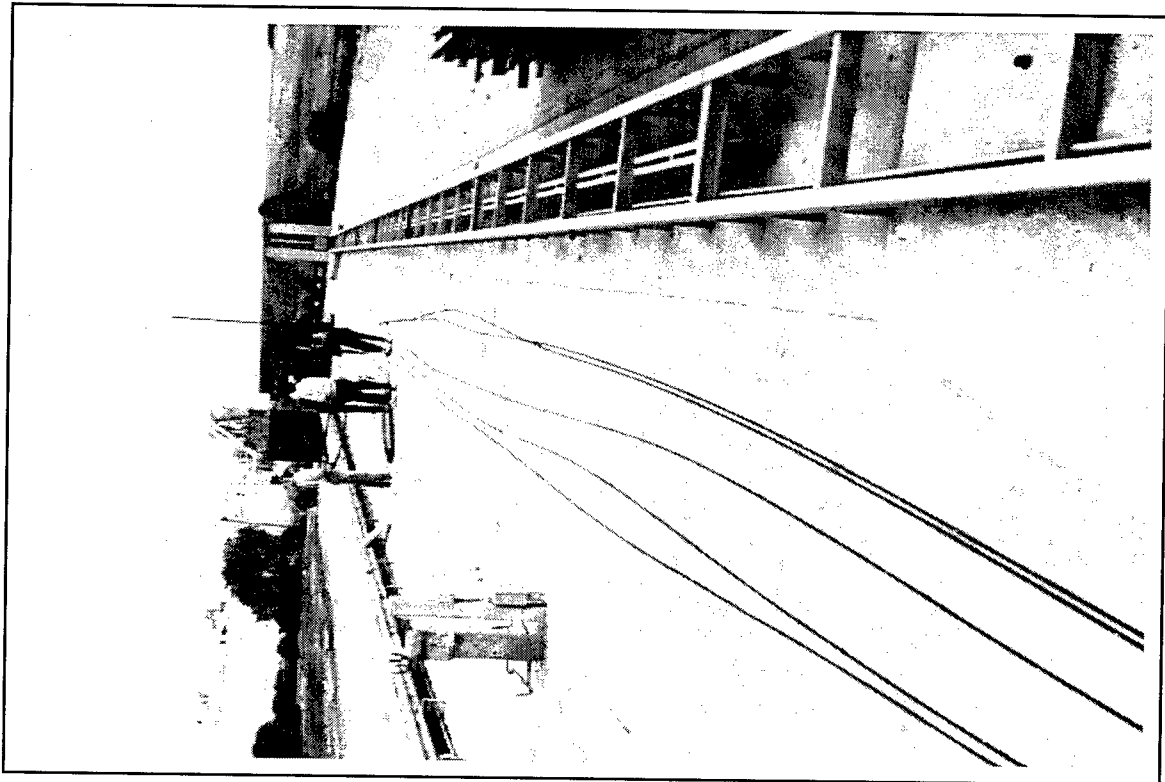

Figure 6. CFRP cables uncoiled and ready for placement.

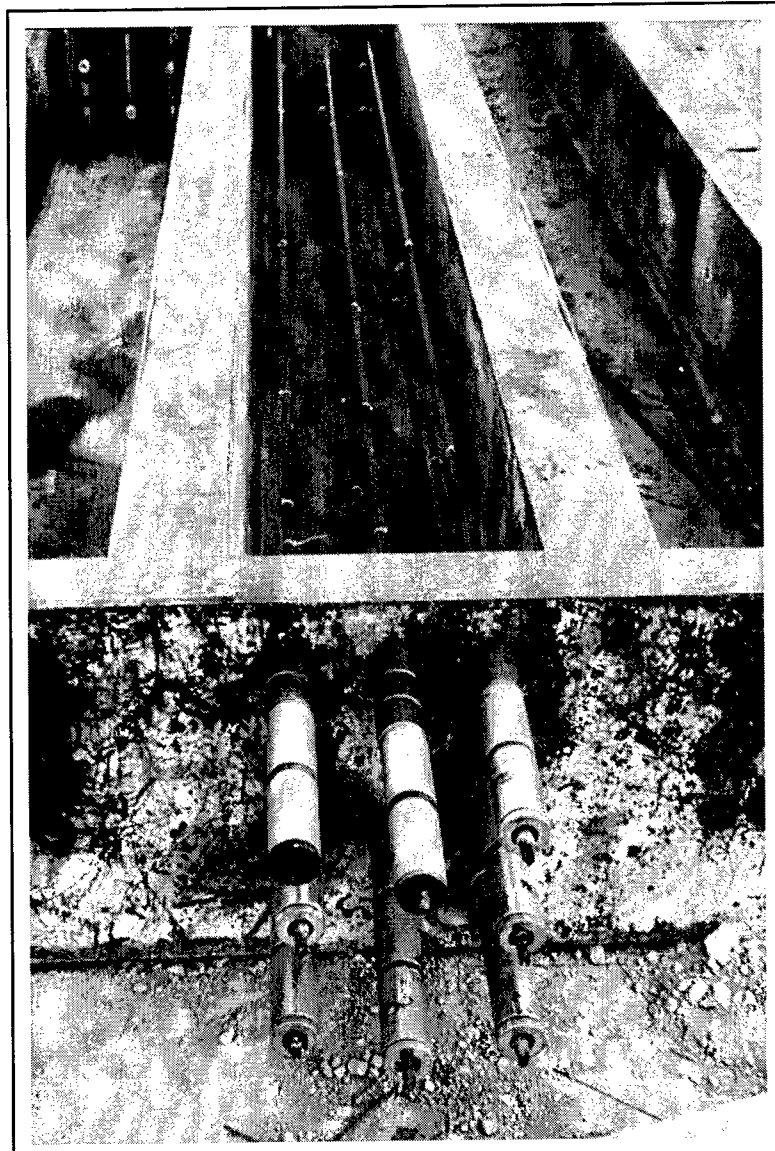

Figure 8. Conventional chucks at the dead end.

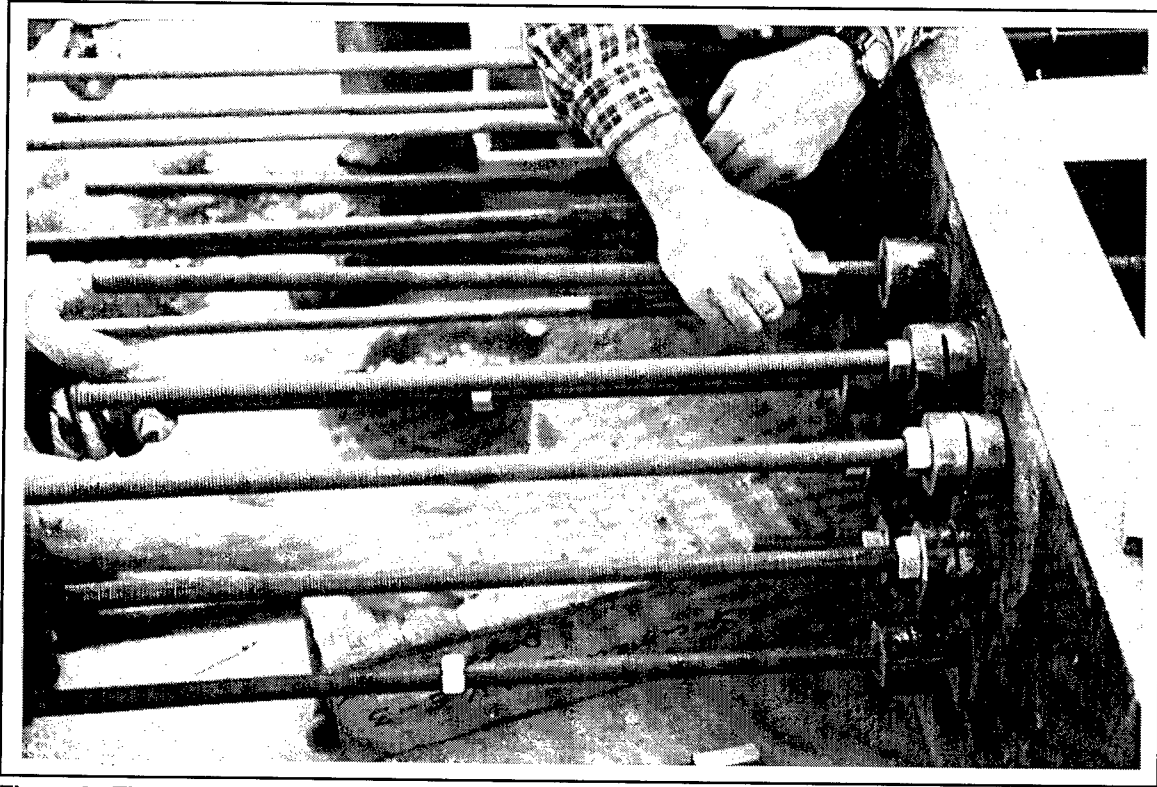

Figure 9. Threaded rods at the jacking end.



Figure 11. CFRP spirals spread at required pitch.

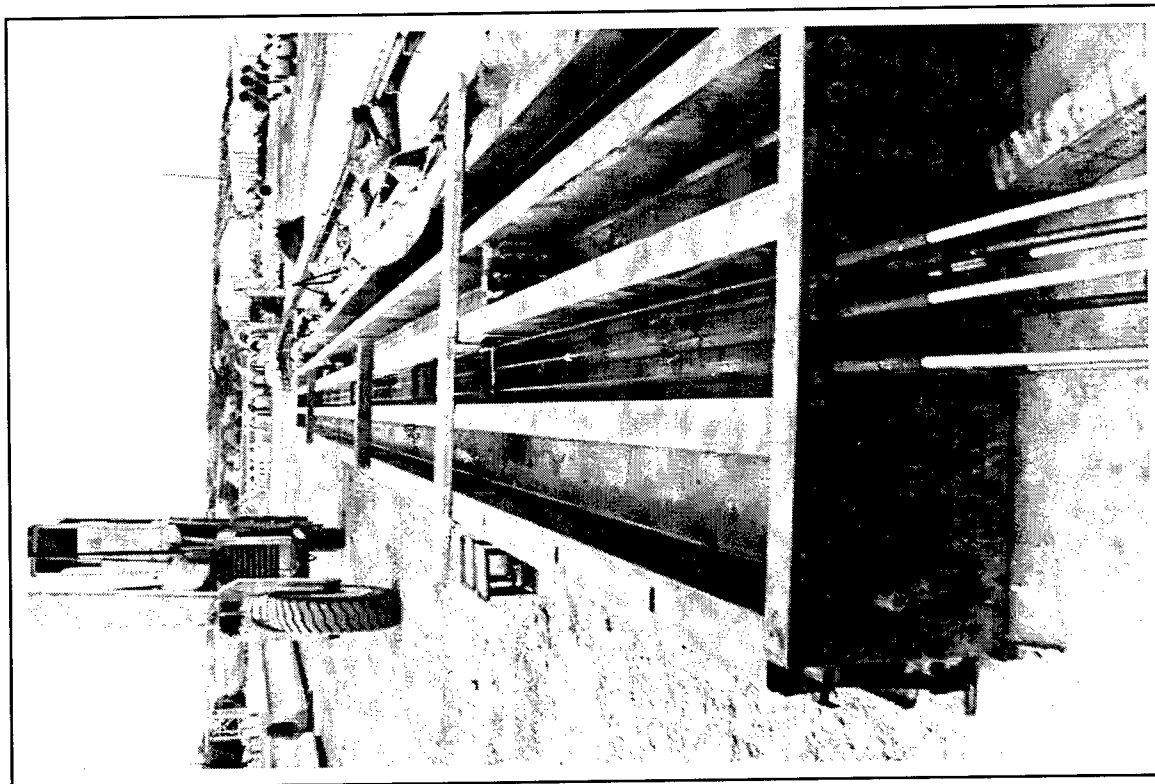

Figure 10. CFRP cables with 50 ft lb of torque for uniform tension before jacking.

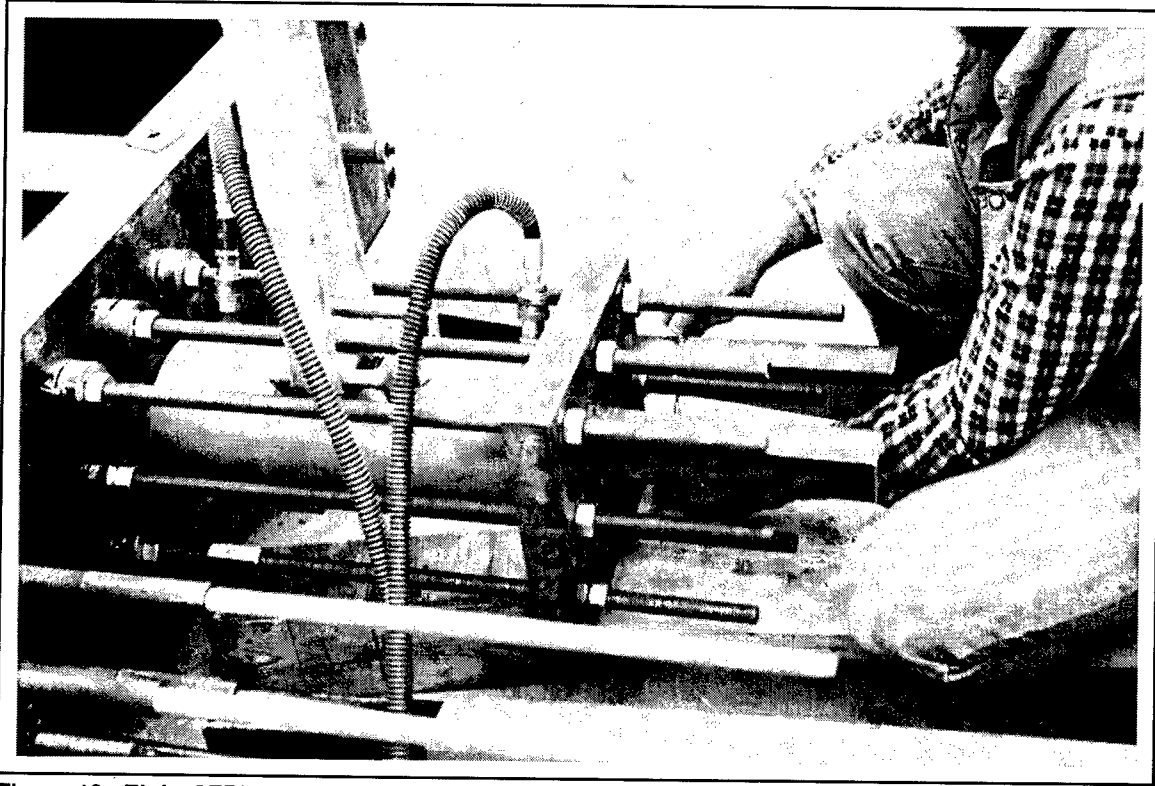

Figure 12. Eight CFRP cables being stressed with a jack.

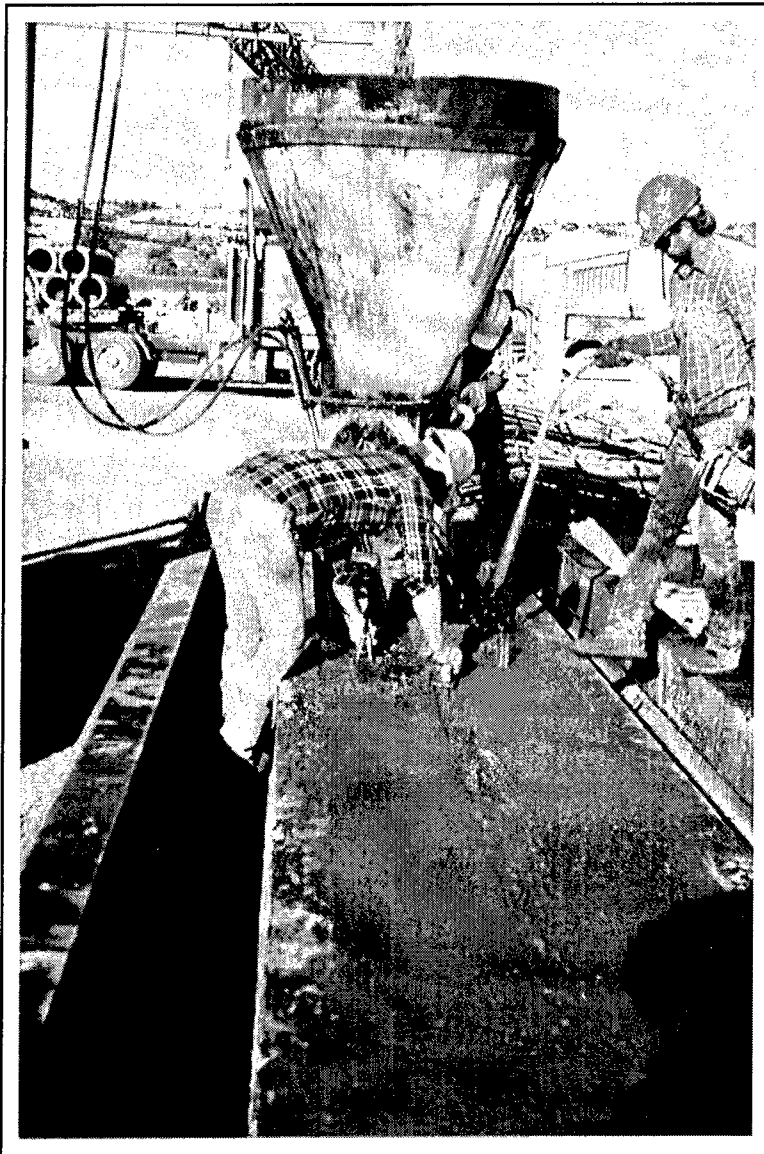

Figure 13. Conventional needle vibrators used to consolidate the concrete.

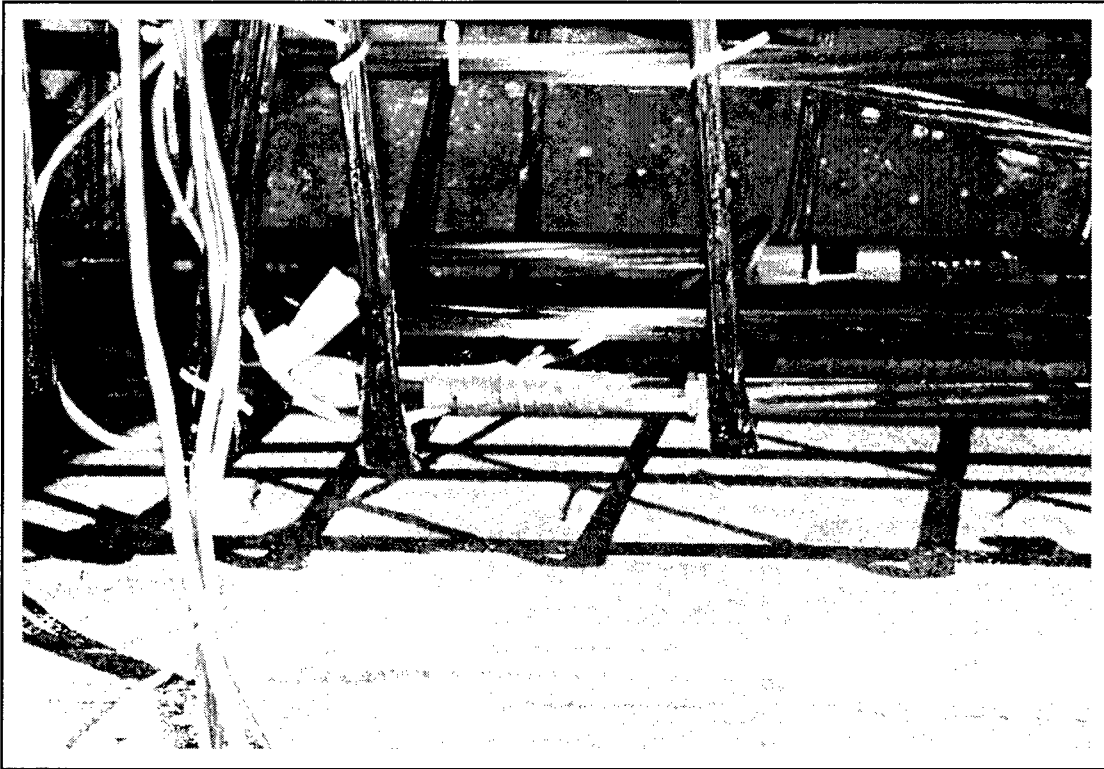

Figure 14. Strain gages on the CFRP cables.

5 Design and Construction of Deck Slab

Preliminary Deck Slab Design

The detailed calculations for the design of the deck slab are shown in Appendix D. The summary of long-term losses, and the initial and final stresses are shown in Table 3. The initial and final stresses are compared to the allowable stresses in accordance with Chapter 18 of ACI 318. The construction sequence used for prestressing the deck slabs was also documented in the literature by Vulcan 1994.

Initial Stresses (Prestress Plus Dead Load)

Transfer/anchorage after re-stressing = 2% (Ranganathan 1994)

Strength of concrete at the time of transfer of prestress = $f_{ci}' = 4$ ksi

Initial prestressing force per cable = 22.5 kips

Deducting 2% for short-term losses, prestressing force = 22.05 kips.

$$\frac{P}{A} = \frac{20 \times 10}{12 \times 18} = 0.926 \text{ ksi} \quad [\text{Eq 1}]$$

Live load Moment = $PL/4 = 25\text{K/ft} \times 17.5 \text{ ft}/4 = 109.38 \text{ ft kips} \times 12 = 1312.56 \text{ in. kips}$

Dead load moment = $wl^2/8 = 0.225 \text{ K/ft} \times 17.5^2/8 = 8.61 \text{ ft kips} \times 12 = 103.35 \text{ in.kips}$

Stress due to live load = $1312.56/648 = 2.025$ ksi

Stress due to dead load = $103.35/648 = 0.159$ ksi

$$\begin{aligned} \text{Initial stress on top} &= \frac{P}{A} - \frac{P \cdot e}{Z_{xx}} + \frac{M_{dl}}{Z_{xx}} = 1.021 - 1.259 + 0.159 \\ &= -0.079 \text{ ksi (tension)} \end{aligned} \quad [\text{Eq 2}]$$

$0.079 \text{ ksi} < 3(f_{ci}')^{1/2} = 0.189 \text{ ksi}$, OK

Initial stress on the bottom =

$$\begin{aligned} \frac{P}{A} - \frac{P \cdot e}{Z_{xx}} + \frac{M_{d,l}}{Z_{xx}} &= 1.021 + 1.259 - 0.159 \\ &= 2.121 \text{ ksi (compression)} \end{aligned} \quad [\text{Eq 3}]$$

2.121 ksi < 0.6 fci' = 2.4 ksi, OK

Initial expected stress = 2.121 ksi (compression on the bottom)

= 0.079 ksi (tension on the

top)

Stress at the centroid of reinforcement, fcir = 1.443 ksi.

At the time of laboratory testing, the long term losses have not taken place.

Hence at the time of testing :

$$\text{Live load for zero tension} = \frac{(2.121 + 0.079) \times 4 \times 648 \times 9}{17.5 \times 12} = 244.38 \text{ kips}$$

244.38kips > 225 kips, OK

Final Stresses After Long-Term Losses

Area of one cable = 0.1338 in²

29.9 ksi on cables = (29.9 x 0.1338)/22.05 = 25.2 %

Final stress due to prestress after long term losses = (1-0.252) x (1.021 + 1.259) = 1.705 ksi (compression at bottom) = (1-0.252) x (1.021 - 1.259) = 0.178 ksi (tension at top)

Final stress at bottom with dead load of slab and live load

= 1.705 - 2.025 - 0.159 = 0.479 ksi ~ 0.464 ksi, OK

Final Stress at top with dead load of slab and live load

= -0.178 + 2.025 + 0.159 = 2.006 ksi < 0.45 fc' = 2.25 ksi, OK

Prestressing Frame

The pre-tensioning method required a prestressing frame to hold the prestressing force temporarily. Each cable was stressed to 22.5 kips force, so with 90 cables the prestressing frame had to safely handle a load of about 2 million pounds.

The prestressing frame consisted of two cross girders to serve as bulkheads and two longitudinal girders to keep the cross girders apart. The longitudinal girders were designed as columns for a maximum axial load of 900 kips. The cross girders were designed as plate girders.

The cross girders consisted of two W30 X 116 girders, joined at the midheight of their webs by a W36 X 160 girder, as shown in Figure 15. The webs of W36 X 160 girders were strengthened with two 1/2 in. thick plates welded to them. Holes were drilled on these cross girders following the cable layout pattern. The hole pattern was drilled with precision to ensure that the cables would run straight from one end of the frame to the other.

The longitudinal girder was fabricated by placing two W30 X 116 beams upright and welding them together every 4 ft with 1 in. X 3 in. plates, as shown in Figure 16. The girders were fabricated by Dakota Steel Corporation in Rapid City, SD. The materials for the frame were supplied by South Dakota Department of Transportation.

Prestressing Frame Test and Verification of Losses

The prestressing frame was tested to ensure that it could handle 1.8 million lb of prestressing force. Eighty-nine 1/2 in. diameter steel cables and one CFRP cable were used for stressing the frame (see next paragraph). Strain gages were mounted on the frame and monitored during stressing. Dial gages were set on the sides of the longitudinal and cross girders to measure the deflections.

The stressing operation consisted of stressing the center 10 cables (Set 5) first, and then stressing the cable sets on each side alternately. One CFRP cable was also stressed along with the steel cables to get an idea of the losses. The strains measured on the steel frame were less than design values.

Even though several cables of different lengths were tested for estimating the transfer and anchorage losses, it was necessary to verify these losses for the exact length used in the actual construction of the deck slab. Two 30 ft cables were made and tested in the same prestressing frame where the deck slabs were constructed. These tests provided valuable information on the immediate losses due to chuck seating and transfer losses. The cable was stressed to about 75 percent of ultimate stress (186 ksi) and the nut was chisel-tightened. The immediate transfer loss was 0.32 percent and increased to 9.56 percent during the first 28 hours. The cable was then restressed to approximately the same stress level, and the immediate loss was 0.25 percent which increased to 2.12 percent after 70 hours. The reduced losses may be explained by the fact that most of the chuck seating losses had already occurred in the first round of stressing.

A similar test was performed on another cable. The immediate transfer loss was 0.36 percent and increased to 1.87 percent at the end of the first hour. In this case, the cable was restressed in 1 hour and the immediate loss after restressing was 0.26 percent. This second loss increased to only 1.4 percent after 22.5 hours. These tests clearly indicated the advantage of restressing the cables after the initial procedure. Therefore, restressing was recommended for the actual stressing of the cables for the deck slab. A value of 2 percent was used for transfer loss in the design calculations.

Cables And Anchorages

Each deck required 90 CFRP cables in the form of prestressed reinforcement. In addition, distribution reinforcement was provided both at top and bottom of the slab at 6 in. c/c (center to center) in both directions. All the cables were made in the Advanced Composite Laboratory at SDSM&T. The pultruded strands for making the cables were supplied by NEPTCO. Spiral reinforcements made with CFRP fibers and epoxy were provided at the four corners of the slab to take care of the bursting stresses, which will develop in concrete due to local stress concentration. These were provided for a length of 2.5 ft around the outermost sets of 10 cables.

The cables were made for a standard length of 30 ft each. Each cable was made by twisting seven pultruded strands (0.156 in. diameter) and securing them at short intervals with plastic ties.

All the cables made for prestressing the deck slab were provided with a tube anchorage at the jacking end and conventional anchorage at the dead end. All the cables were color-coded and stored safely for prestressing. The nonprestressed reinforcements (distribution reinforcement) were made in two standard lengths, 8 ft, 10 in. along the width and 19 ft, 10 in. along the longitudinal direction. They were also made in the same way as the cables used for prestressing with no anchorages. Sixteen-inch CFRP cables were provided at quarter-span length for vertical reinforcements.

All the conventional anchorages were checked with the regular 0.6 in. diameter steel chucks and were carefully transported to the prestressing bed.

The spirals were made with T-300 CFRP fibers and epoxy resin. They were wetted with Shell 815 resin and wound on a 10 in. X 10 in. form. The spirals were removed from the form and stored after the resin had cured. The spirals were made at a pitch of 3 in. c/c.

Formwork

The floor of the formwork required a special design to support the load, which was a slab 18 inches and 225 psf. The formwork for the floor had to be raised to match the holes on the prestressing frame and the end pieces of the formwork for a proper cable layout.

The floor of the formwork was constructed by placing 2X8 timber joists on edge in the longitudinal direction at 1 ft intervals. A lateral sway bracing was provided every 4 ft. Three-quarter-inch plywood was used for the floor. The plywood was nailed to the 2X8s securely. To raise the floor of the formwork to the required height, the whole platform was supported on pairs of 2X4s nailed together and placed along the shortest direction on edge. The form floor was then leveled. The sides along the longitudinal direction were made with 3/4 in. thick plywood with 2X4s, and abutted against the longitudinal girders (see Figure 17).

The end pieces were made with 2X6 framing and 3/4 in. plywood. Holes were drilled into the plywood according to the cable layout, so that a straight cable can be passed through all the holes on the cross girders and the two end pieces of the formwork without any contact. Care was taken to see that the cables did not touch the sides of the holes since it could damage the cables and possibly cause failure due to cable rubbing against the edges of the holes while stressing. The end pieces were nailed securely to the floor planks and were braced with 2X4s against the surrounding girders. Forty-five degree chamfer fillet pieces were placed on the inside bottom edges.

Once the final adjustments were made, the formwork was cleaned and oiled. Once Deck 1 was completed, the formwork was removed and the same form was used for the Deck 2 with little repair.

Pre-Tensioning of Deck Slabs 1 and 2

Once the formwork was placed in position, the bottom cables were first inserted one by one and conventional steel chucks were put on the dead end of the cable. Threaded steel rods (7/8 in. diameter) were fixed on the tube anchorage with specially designed couplings. On the ends of the cable sets 1 and 9 (cable numbers 1 through 10 and 81 through 90) the spirals with a pitch of 3 in. and length of 2.5 ft were inserted and tied to the cables (see Figure 18). Nuts were put on the threaded rods on the outside of the cross girder and tightened against the cross

girder. A torque wrench was used on the nuts to put some initial tension put on the cables so they would remain taut. The bottom layer of distribution reinforcement was tied to the cables at 6 in. c/c, allowing for the extension of the cables. Subsequently, all the other cables were inserted in their places and were provided with some initial tension using a torque wrench. Figure 19 shows the threaded rods connected to the tube anchorages on the jacking end of the prestressing frame, and Figure 20 shows the conventional steel chucks on the dead end. Figure 21 shows the cable layout.

The sequence of operation was very important due to the large number of cables used. It was designed in such a way that the prestressing frame would maintain stability.

Prestressing Deck Slab 1

Two jacks of different capacities were used for the prestressing operation. The large one with 100-ton capacity (Jack 1) was used to pull eight cables at one time. The other smaller jack (Jack 2) was used to stress single cables in the bottom row. This was done because of the size of the jacks. Before prestressing operations began, cables 1, 5, 41, 45, 46, 50, 86, and 90 (Figure 21) were instrumented with strain gages at the midspan of the slab. In spite of the careful waterproofing, past experience showed that strain readings fluctuated because of the moisture after concreting. Therefore, additional strain gages were installed outside the forms near the jacking end (live end) on cables 5 and 50 to keep track of the strain readings while the concreting was done. The strain readings in the cables subsequently stabilized after the curing of concrete.

First, the top eight cables of central cable set 5 were stressed with Jack 1 to a prestressing force of approximately 22,500 lb per cable. The nuts on the threaded rods were tightened against the bulkhead after the cables had extended. An alternating stressing sequence similar to that described earlier in this chapter was carried out to maintain stability in the prestressing frame. This was done for all remaining cables in the deck (Figure 22).

Prestressing Deck Slab 2

Strain gages were installed on all 10 cables of the central set 5 (cables 41 - 50) while prestressing the cables for Deck 2. There was a slight change in the sequence of prestressing compared to the operation followed for Deck 1. The bottom cables were stressed first, starting with the central cables 45 and 46, then stressing the cables

on either side alternately (35, 36 and 55, 56). The actual force in the cables varied between 21,000 and 23,000 lb.

The stressed cables were left overnight to allow for chuck seating. Restressing of all the cables to the design stress was done the following day before placing concrete.

In Deck 2, two vertical plastic ducts of 2 in. diameter were arranged at the center of the slab, 1 ft apart longitudinally. These ducts allowed two 1 3/8 in. diameter threaded rods to pass through for testing the slab (Figure 23.)

Placement of Concrete

After the completion of restressing operation, concreting was done by a subcontractor. A movable ramp was built across the longitudinal girders to enable easy placing and finishing of concreting. Concreting was started at one end and needle vibrators were used to compact the concrete (Figure 24). Once the concrete was placed to a depth of 15 in., the top layer of distribution reinforcement—in the form of a 6 in. X 6 in. grid—was placed (Figure 25). The remaining 3 in. of concrete was placed, vibrated, and broom finished. During the concreting process, six cylinders were cast with each slab for conducting compressive strength tests.

Curing of Concrete

A special method of curing was developed to replace conventional steam-curing method used in the plant environment. The concrete slab was covered with wetted burlap. A polyethylene sheet was placed over the burlap to prevent moisture escaping. Electric blankets were placed over the plastic for thermal curing. Insulation blankets were spread on the top of the heating blankets. This method of thermal curing was used so the concrete would attain its design compressive strength faster than the normal. The concrete temperature was monitored using thermocouples, and was maintained between 120 °F and 140 °F.

Cylinders were tested at the end of 24 and 48 hours to check if the concrete had developed enough strength for the transfer of prestress. The strengths thus recorded at the end of 24 and 48 hours were 2400 and 4070 psi for Deck slab 1 and 3930 and 4970 psi for Deck slab 2, respectively.

Destressing Operation

On the second day, when the concrete had developed its initial strength of 3500 psi (initial concrete strength assumed as $f_{ci} = 0.7f_c$), the prestress was transferred to the concrete by releasing the cables from the prestressing frame. The cables were pulled with the jack until the nuts on the threaded rods became loose. The nuts were then retracted back and the force on the jack was slowly released. An operational sequence similar to stressing was followed for destressing the cables. All the cables were partially destressed first. This was done in order to avoid the sudden transfer of forces to other cables which would increase the stress levels and possibly cause a chain reaction failure of cables.

Just before the destressing operations began, three 2-in. strain gages were installed on the deck slab at midspan across the width—one at 6 in. from either end and one at the center. The strains recorded were to confirm the amount of stress introduced in the concrete.

Quality Assurance

The most important parameters are the modulus and ultimate strength of the prestressing reinforcements. A statistical analysis can be conducted to determine the 95 percent proof stress. The type of distribution used might vary depending on the size of samples. Modulus can be determined similarly with a probability of 95 percent. The quality assurance for the anchorages used has been very well confirmed by conducting long-term sustained tension tests on these cables for 2 years (Gorty 1994; Sivakumar 1995).

Laboratory Testing of Deck Slab 2

Deck slab 2 was tested in static flexure for a load of 225,000 lb over a 30 in. square area. Two 1 3/8 in. diameter steel (200 ksi) Dywidag prestressing rods were used for applying the load (see Figure 26). A self-straining frame was set up using the same girders for the prestressing frame (Figure 27) and a hydraulic jack was used to apply the load. The details of testing can be found in Ranganathan (1994). A load was applied in 25,000 lb increments and all strain and deflection readings were recorded (Figure 28). The load deflection behavior was linear, as one would expect for an uncracked section. The slab was thoroughly investigated for cracks. The dial gages mounted on the ends of the cables did not show any slippage. The dimensionless load distribution coefficient, K , was computed by dividing the individual

deflection at a point with average deflection across the width of deck slab. The K values at every point were close to 1.0, suggesting that the entire width of the slab was effective in taking the load. The K values were also computed for strains in the concrete, and they also were close to 1.0.

After the successful completion of static flexure testing for a load of 225,000 lb, the deck slab was subjected to a short-term sustained load of 150,000 lb for a period of 2 weeks. The deflections across the width were monitored at quarter-points. The deflection values stabilized very soon during the first 5 hours. The increase in deflection was negligible over 2 weeks. The residual deflections were also negligible after unloading the deck slab.

Table 3. Summary of long-term losses.

Sl. No.	Type of loss	According to ACI (ksi)	According to AASHTO (ksi)
1	Elastic Shortening	9.47	7.58
2	Creep	15.15	17.32
3	Shrinkage	2.7	5.0
4	Total	27.32	29.9

Maximum loss as per AASHTO was used for the design.

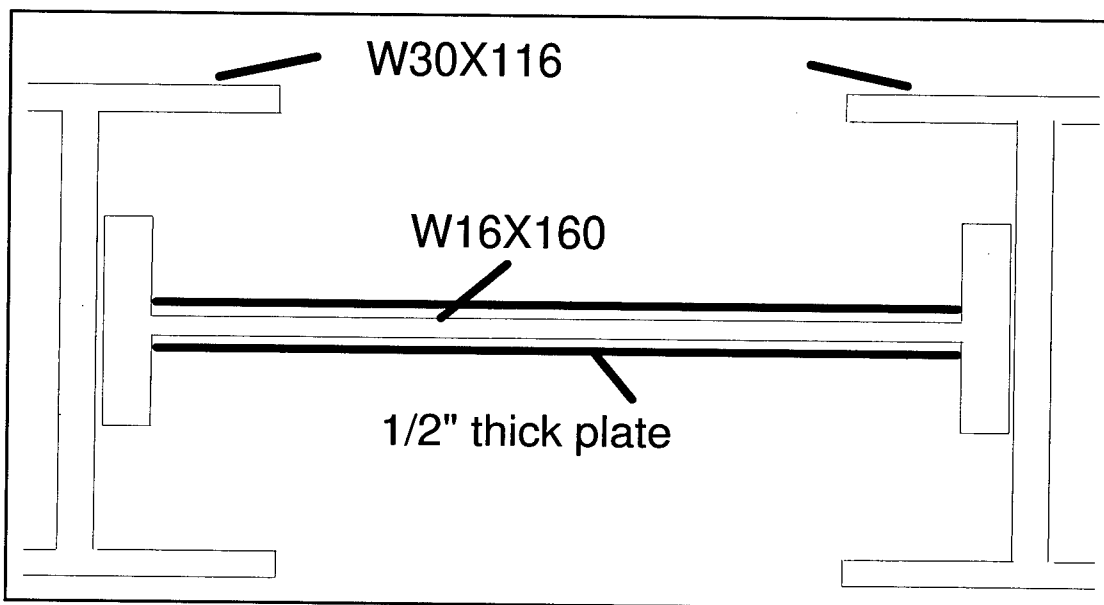

Figure 15. Cross sectional view of cross girder.

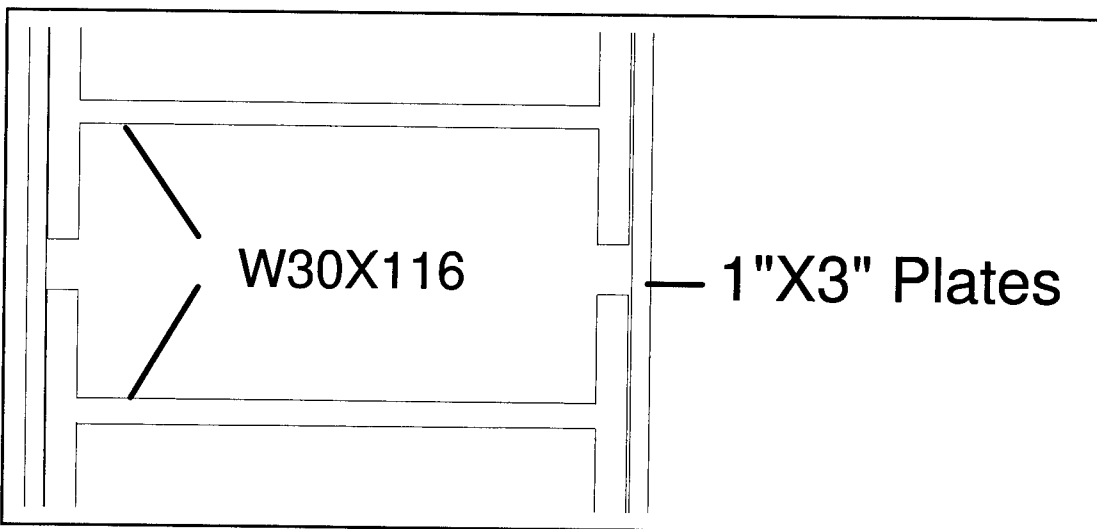

Figure 16. Cross sectional view of longitudinal girder.

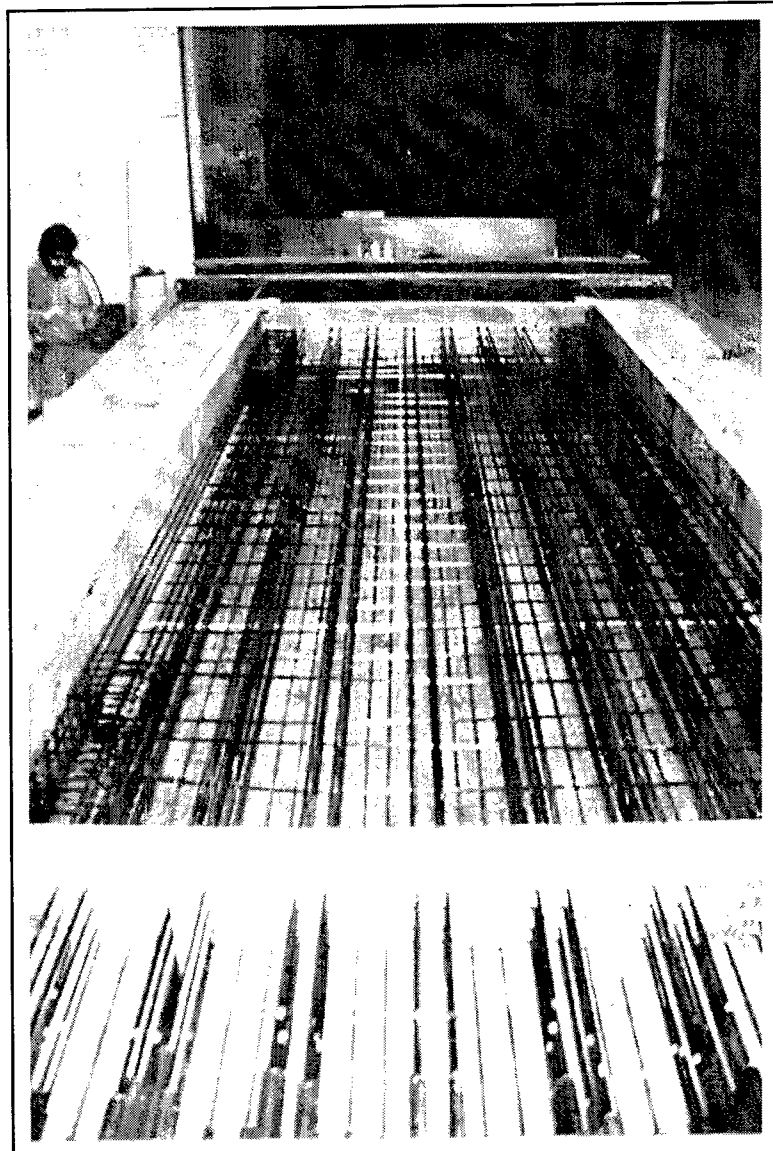

Figure 17. CFRP cables stressed and ready for placing concrete.

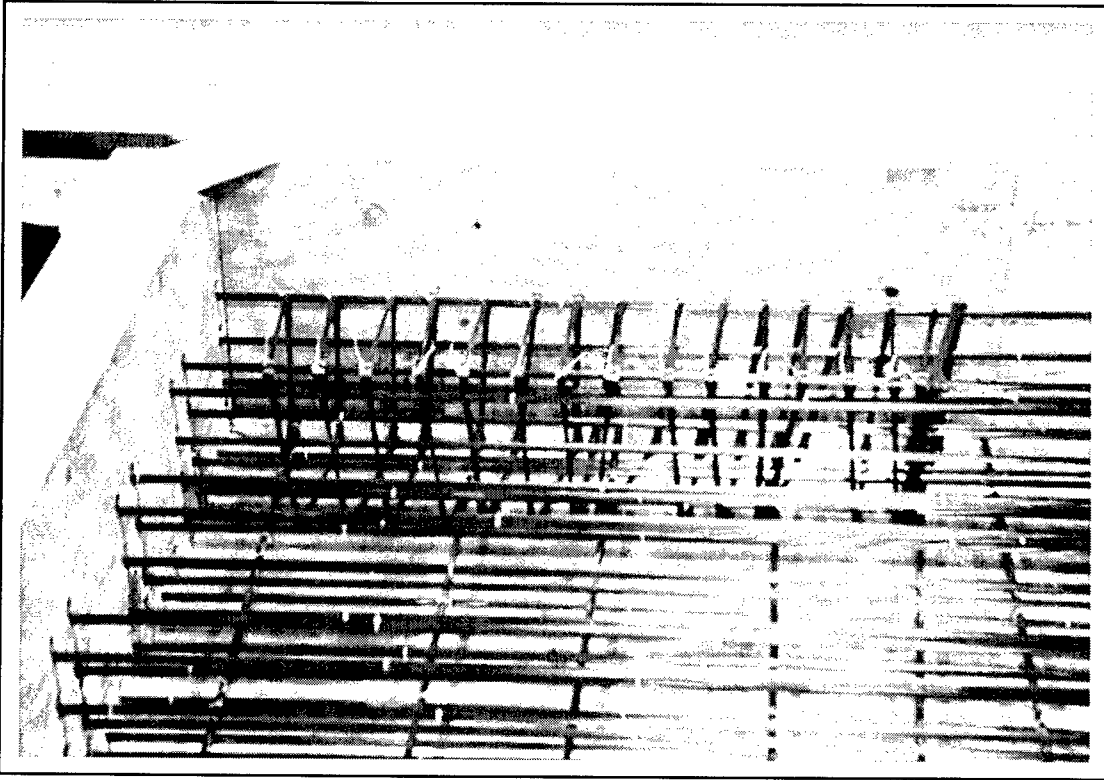

Figure 18. Details of spirals near the corners of deck slab.

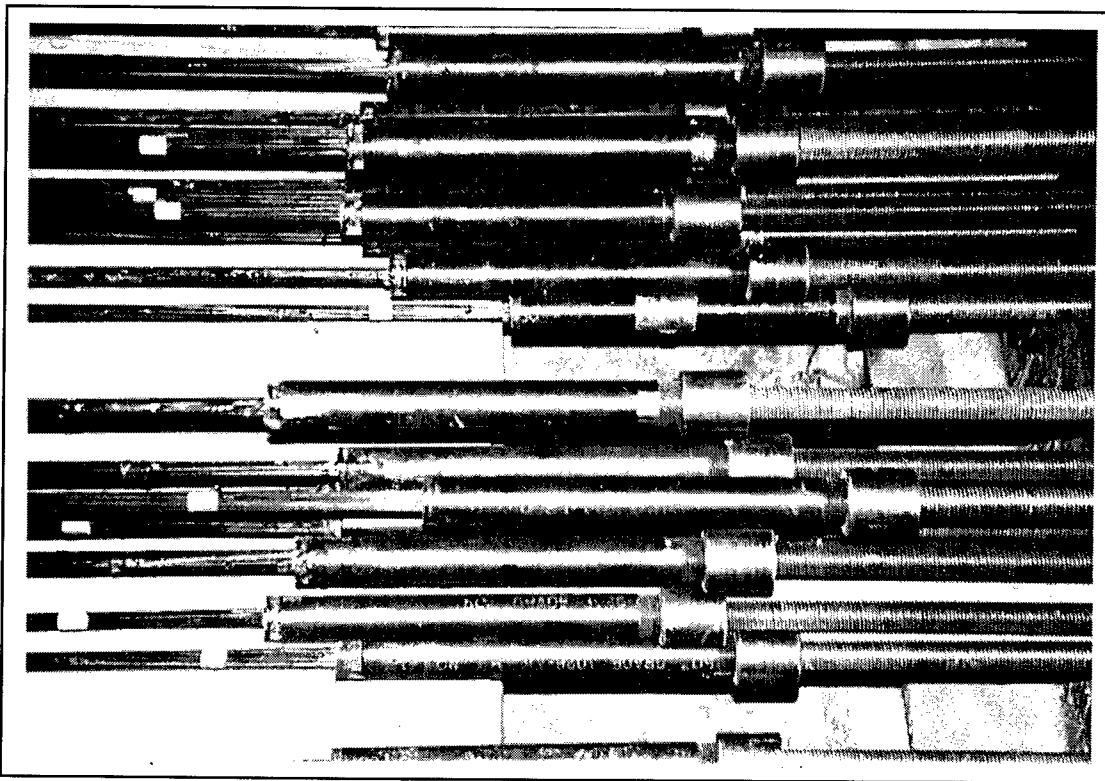

Figure 19. Tube anchorage and threaded rods on jacking end.

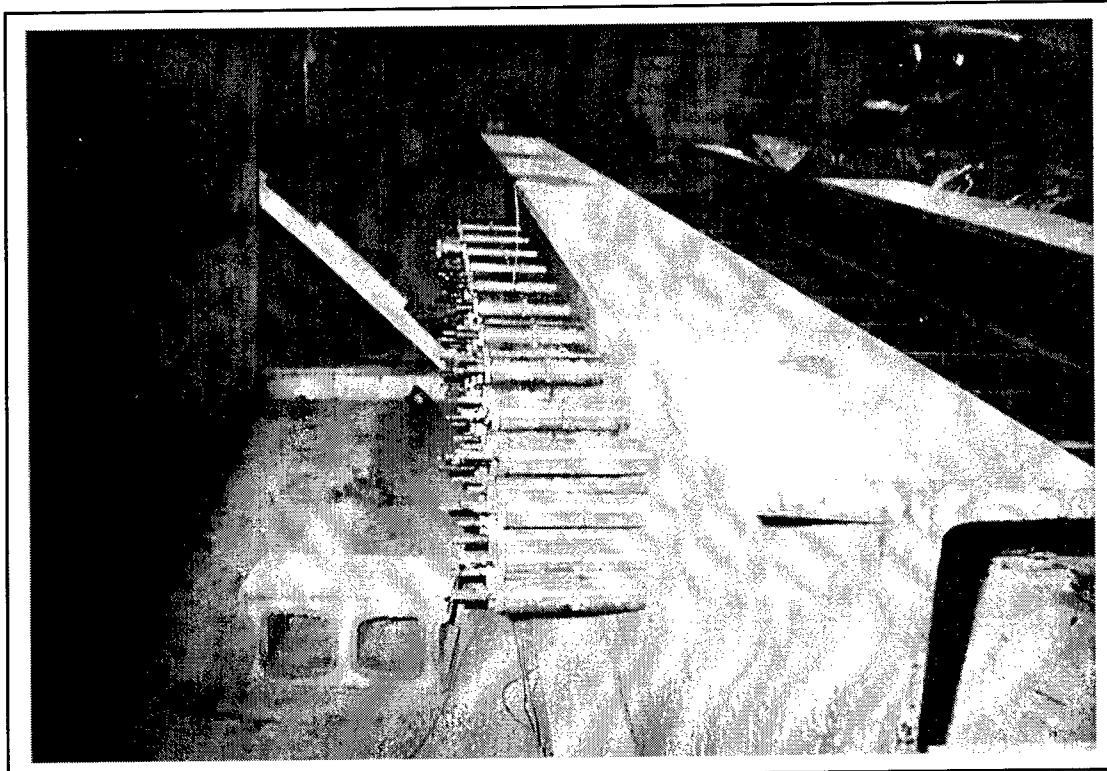

Figure 20. Conventional chucks at the dead end.

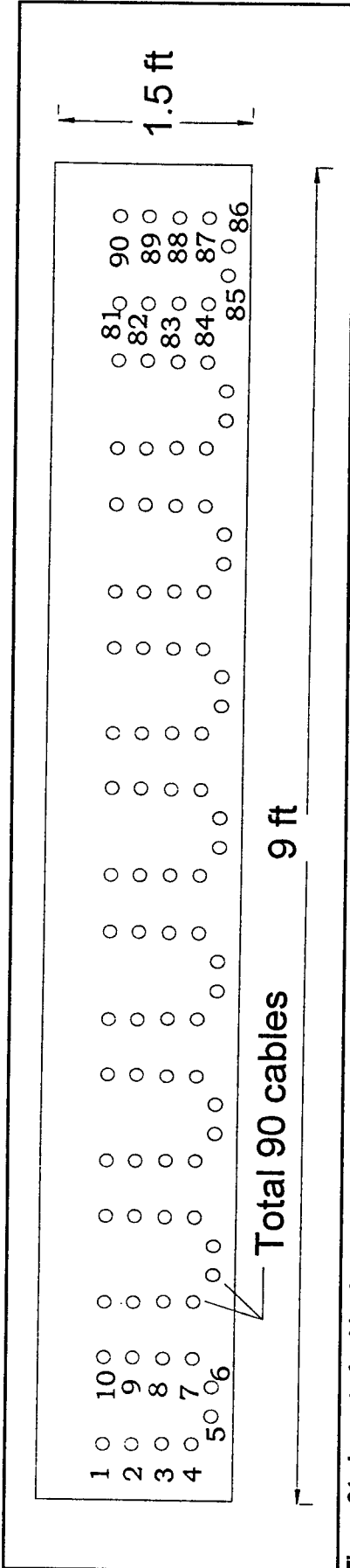

Figure 21. Layout of cables in deck slab.

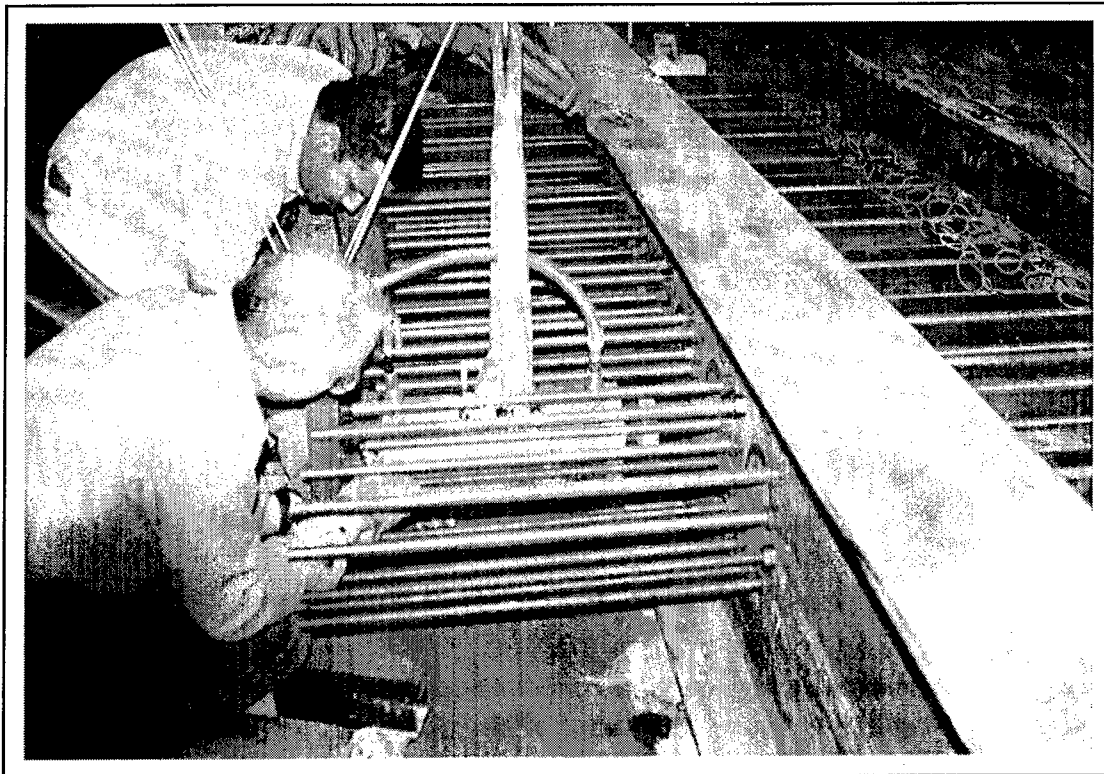

Figure 22. Stressing of top eight cables in progress.

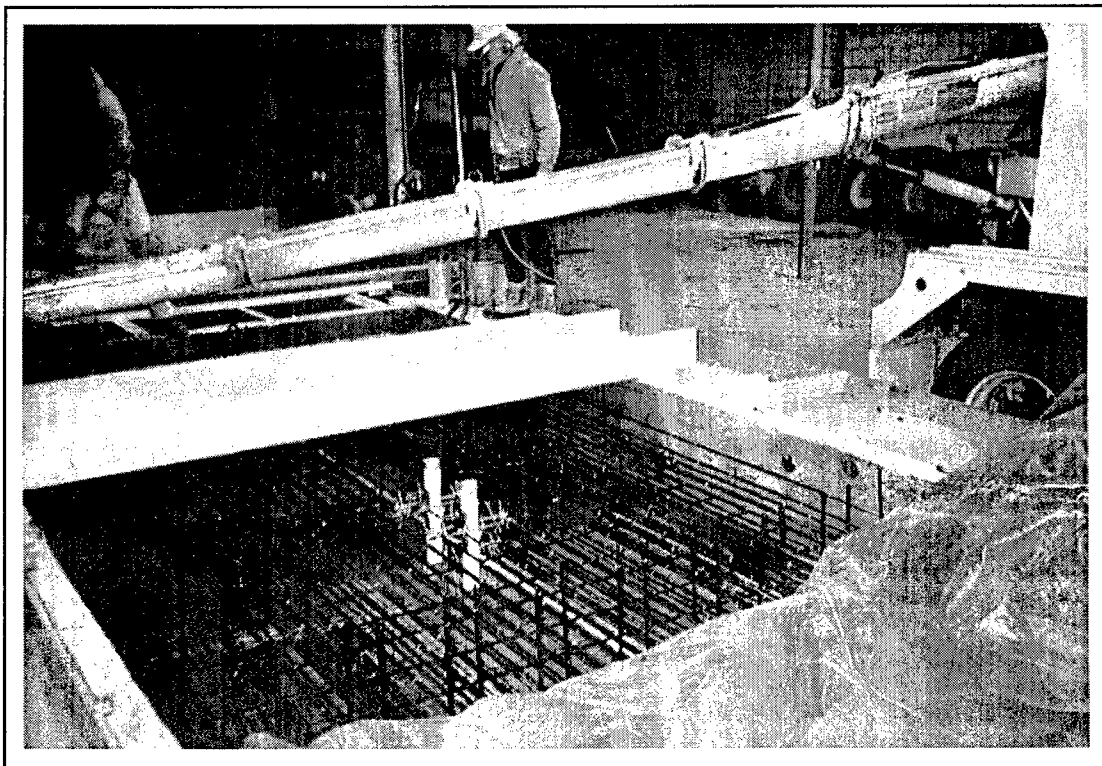

Figure 23. Vertical plastic ducts in Deck 2 to facilitate load tests.

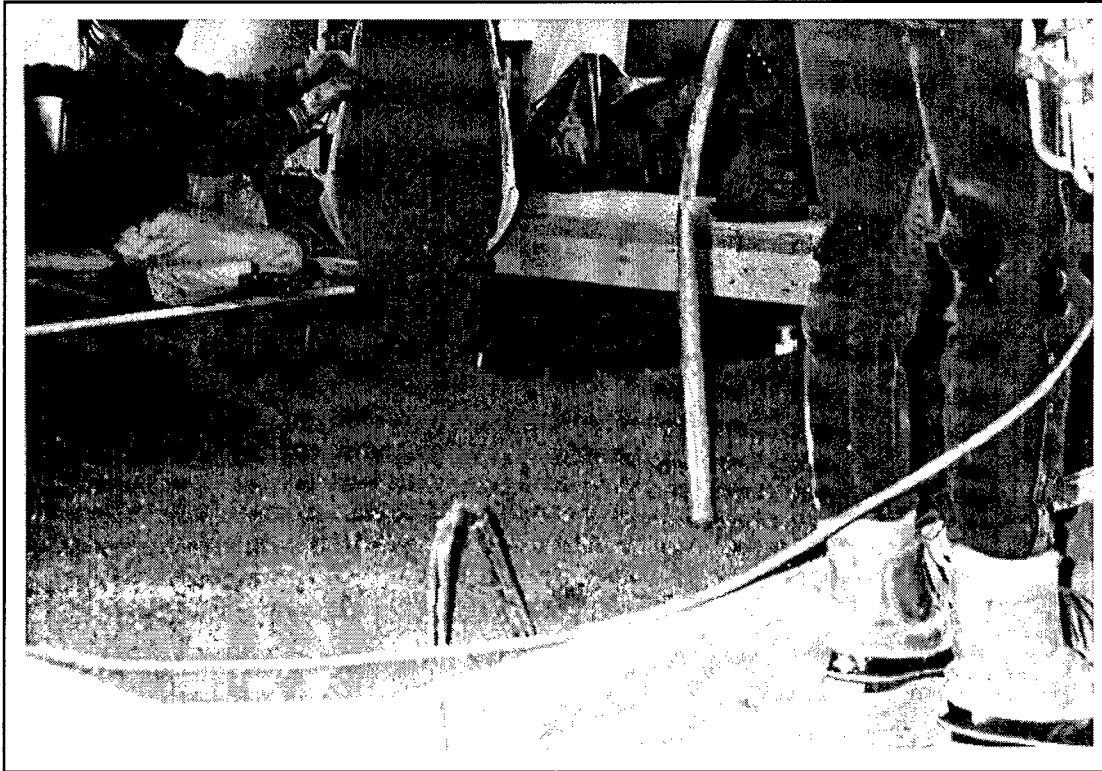

Figure 24. Concreting of deck slab in progress.

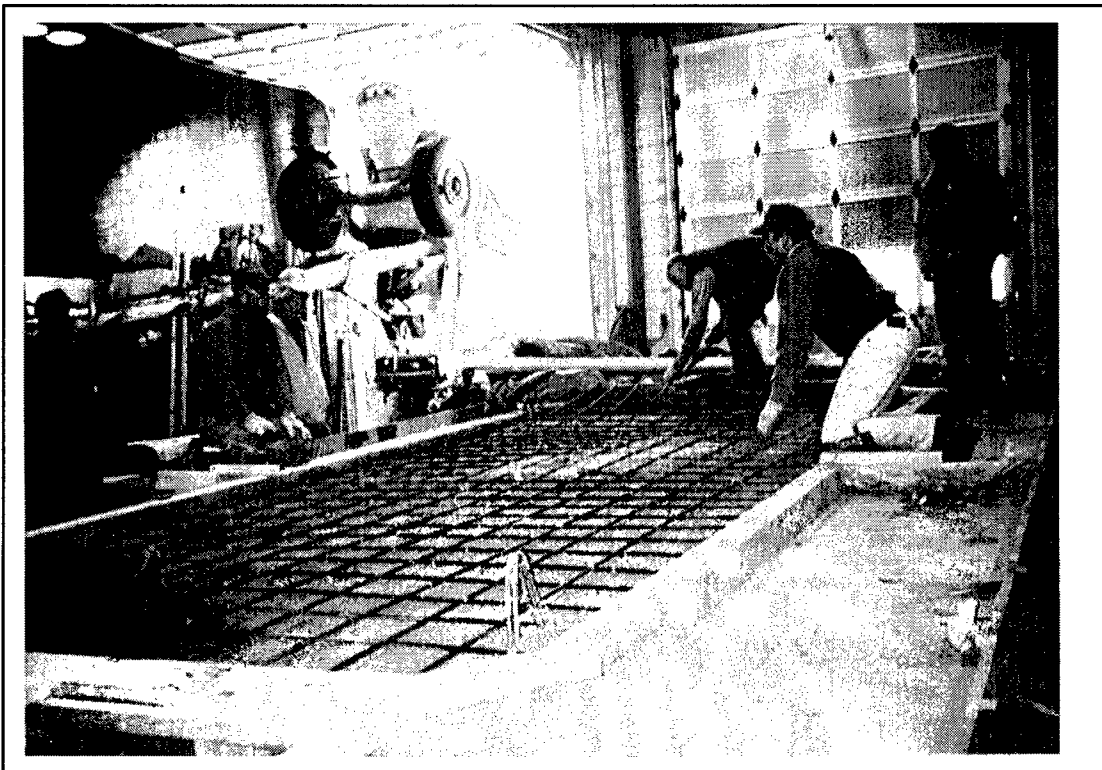

Figure 25. Top layer of distribution reinforcement (CFRP cable) being placed after 15 inches of concreting.

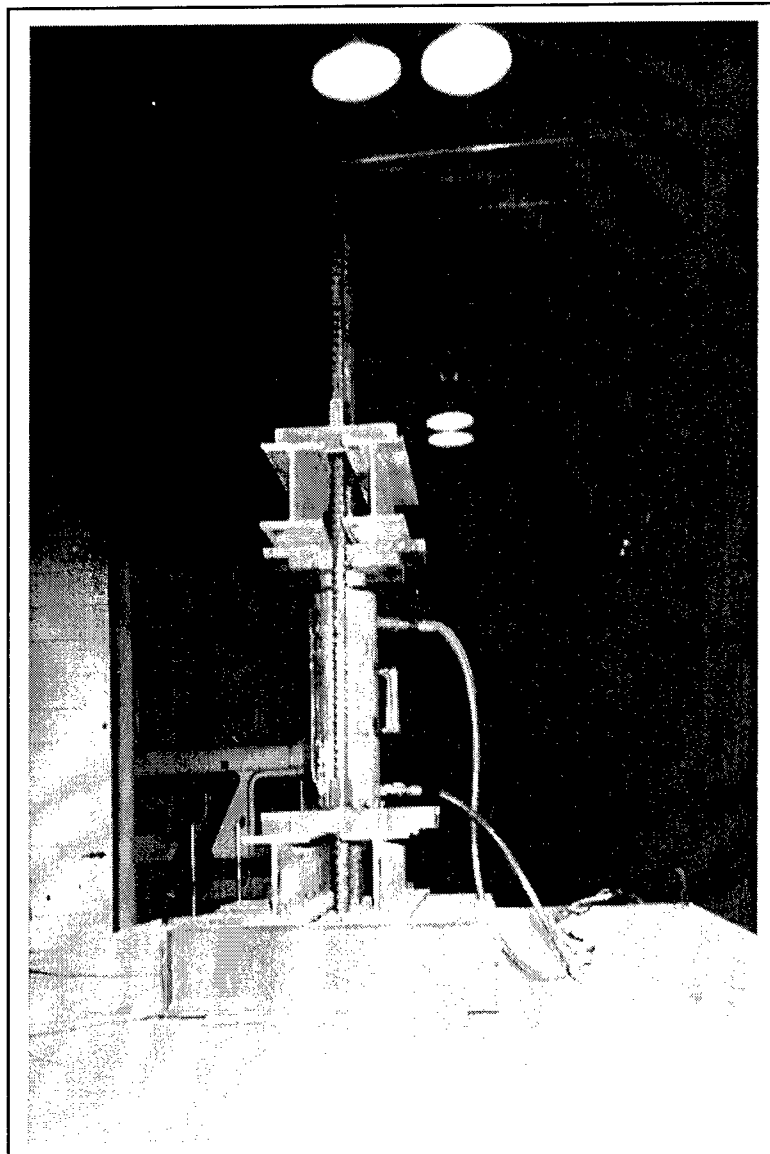

Figure 26. Hydraulic jack setup for loading deck slab 2.

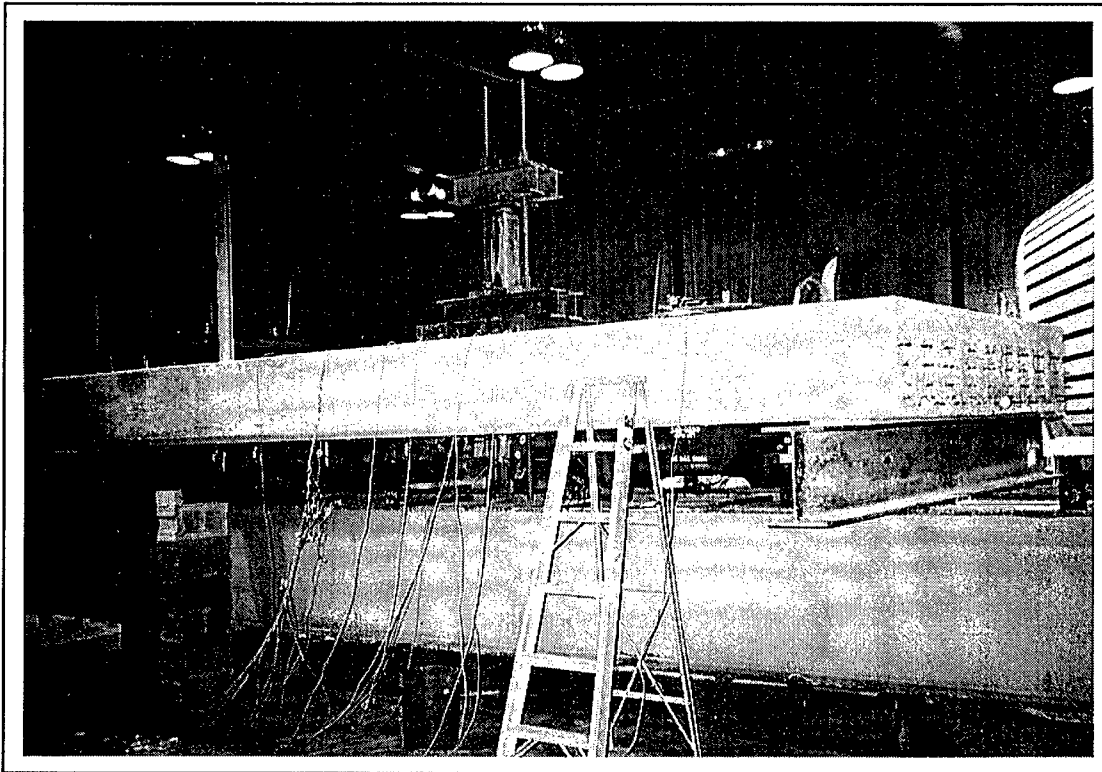

Figure 27. General setup for loading the deck slab 2.

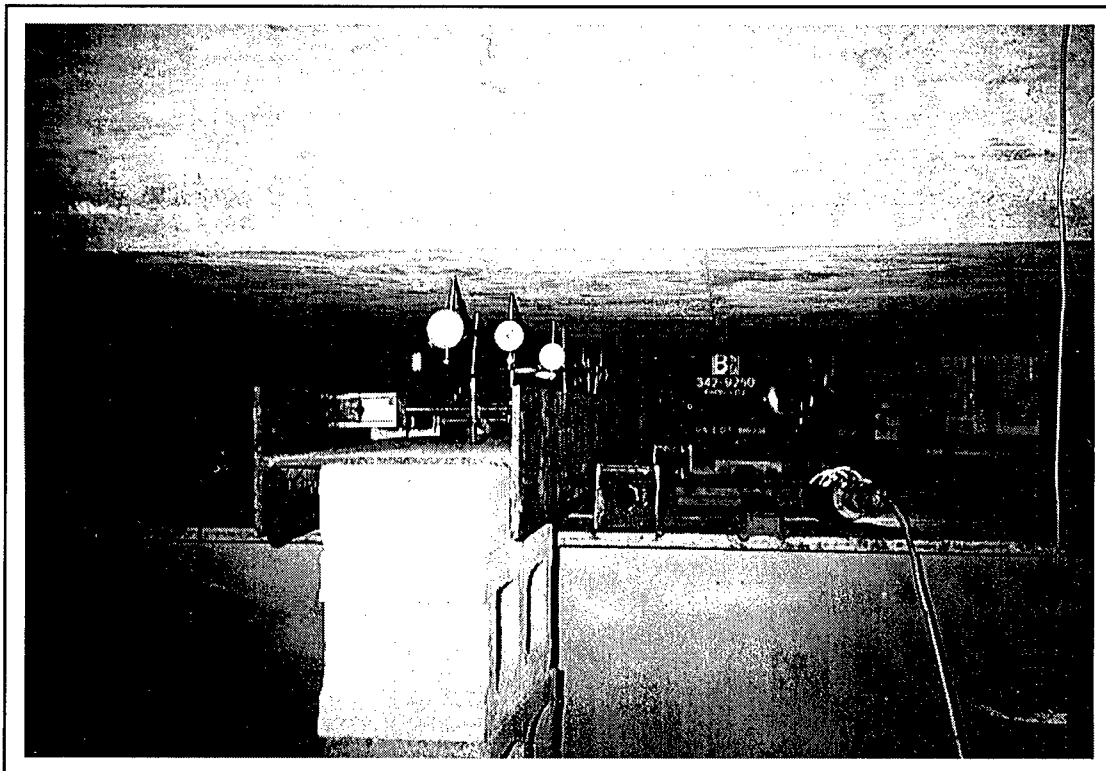

Figure 28. Dial gages for measuring deflection during testing deck 2.

6 Design and Construction of Pile Caps

Pile Cap Specifications

The pile caps were cast in place and prestressed using the bonded post tensioning method. The GFRP cables used in the pile caps were made at the SDSM&T Advanced Composite Laboratory and tested for jacking force before being transported to the site at Port Hueneme, CA. Two beams also were made to simulate the prestressing operation in order to train the crew. One beam was 14 in. x 14 in. x 18 ft and the other was 16 in. x 7 in. x 17.75 ft. These beams were tested in order to check transfer and development lengths, and the mode of failure. Details of the tests are available in Ramabhadran (1995).

Load Calculations

Pile cap cross section is 30 in. wide and 24 in. deep (as shown in Appendix D).

Live load/ft. = $112.5/9.5 = 11.84$ K/ft

Moment due to live load on cantilever portion = $w \times l^2/2 = 29.97$ ft kips

Weight of slab per ft = $0.150 \text{ k/ft}^3 \times 1.5 \text{ ft} \times 10 \text{ ft} = 2.25$ K/ft

Moment due to weight of slab = $2.25 \times 2.25^2/2 = 5.7$ ft kips

Dead load of pilecap = $0.150 \text{ K/ft}^3 \times 2 \text{ ft} \times 2.5 \text{ ft} = 0.75$ K/ft

Moment due to dead load of pile cap = $0.75 \times 2.25^2/2 = 1.9$ ft kips

Total moment = $29.97 + 5.7 + 1.9 = 37.57$ ft kips

Total Shear = $(2.25 + 0.75 + 11.84) \times 2.25 = 33.39$ kips

Section Properties

Initially, the 225-kip load was supposed to have any position on the deck slab. The worst stress situation would have been produced by placing the load directly over the pile cap. A bearing of 15 in. was required for each of the deck slabs on adjacent spans, which brought the width to 30 in. The depth was arrived by the punching shear consideration from 14 in. x 14 in. pile for the 225 kips load. The depth was computed as 24 in. However, the actual loading for this structure was later changed to be kept at the center of deck slab, which would be less severe. But the overall dimensions of the pile cap were kept as indicated in the contract documents.

Area of pilecap, $A = 30 \times 24 = 720$ sq in.

Moment of inertia, $I = 30 \times 24^3/12 = 34560$ in.⁴

Section modulus, $S_{xx} = 30 \times 24^2/6 = 2880$ cu in.

Summary of Long-Term Losses

The losses were computed based on ACI and AASHTO specifications (Appendix E). Table 4 shows the summary of losses.

Elastic shortening loss is included in loss at transfer in the post-tensioning method. Maximum loss according to AASHTO specifications, 7.56 ksi, was used for the design.

Area of cable = 0.1304 sq in.

Percentage loss = $(7.56 \text{ ksi} \times 0.1304 \text{ sq in.}) \times 100 / 16 = 6.16 \%$

The transfer loss (including elastic shortening) for 18 ft length of prestressing was determined to be 4% (14)

Total loss = $6.16+4=10.16\%$

Cable Layout

The layout of cables was determined by the practical considerations of accommodating the 6 in. projection of piles into the pile cap. No cables could be provided at the bottom middle portion of the pile cap. Therefore, an arrangement of cables was worked out with the eccentricity to provide no tension due to prestressing. The minimum distance of 6 in. was required between adjacent cables to accommodate the jack and fixtures used in prestressing. An eccentricity of 3 in. (for the total force) was used with the arrangement of 12 cables shown in Figure 29.

Initial and Final Stresses

ACI 318 specifications were used to check stresses at various steps of prestressing.

Initial prestressing force per cable = 16 kips.

After a transfer loss of 4 percent (inclusive of elastic shortening in post-tensioning), prestressing force in each cable = $0.96 \times 16 \text{ kips} = 15.36 \text{ kips}$

Strength of concrete at transfer = 4000 psi

Initial Stresses in Concrete Due to Prestress and Dead Load of Pile Cap

$$\frac{P}{A} = \frac{15.36 \times 12}{24 \times 30} = 0.256 \text{ ksi}$$

$$\frac{Pxe}{S_{xx}} = \frac{15.36 \times 3 \times 12}{2880} = 0.192 \text{ ksi}$$

Bending stress due to dead load of pile cap; (Dead load moment = 1.9 ft kips)

$$\frac{M}{S_{xx}} = \frac{1.9 \times 12}{2880} = 0.008 \text{ ksi}$$

Initial stress at top = 0.256 + 0.192 + 0.008

= 0.456 ksi. (compression) < 0.6x f_{ci}' = 0.6 x 4.0 = 2.4 ksi, OK

Initial stress at bottom = 0.256 - 0.192 - 0.008

= 0.056 ksi. (compression) < 0.6x f_{ci}' = 0.6 x 4.0 = 2.40 ksi, OK

Final Stresses in Concrete after Long-Term Losses Including Prestress, Dead Load, and Live Load Moment

Prestressing force in each cable after long-term losses = (1 - .1016) x 16 = 14.37 kips

P/A = 14.37 x 12/720 = 0.239 ksi

$$\frac{Pxe}{S_{xx}} = \frac{14.37 \times 12 \times 3}{2880} = 0.059 \text{ ksi} \times 3 = 0.179 \text{ ksi}$$

Bending stress due to dead load of pile cap, dead load of deck slab, and live load;
Moment = 37.57 ft kips

$$\frac{M}{S_{xx}} = \frac{37.57 \times 12}{2880} = 0.156 \text{ ksi}$$

Final stress (bottom) = 0.239 - 0.179 - 0.156 = -0.096 ksi. (Tension) < 3 $\sqrt{f'_c}$ = 3 $\sqrt{5000}$ =
-.212 ksi

Final stress (top) = 0.239 + 0.179 + 0.156 = 0.5746 ksi. (compression) < 0.45x f'_c =
2.250 ksi.

Therefore, the stresses are not critical.

Construction of Pile Caps

Preparation of Cables

Forty E-glass/GFRP cables were prepared for the pilecaps in the Advanced Composite Laboratory at SDSM&T. As in other components, a tube anchorage was

used at the jacking end and conventional anchorage was used at the dead end of each cable. The length of the cable was 20 ft, 7 in. All the cables were tested in a jig for jacking force of 16,000 lb to assure cable quality before shipping. CFRP composite stirrups were made using a method similar to that used for making spirals for the piles. Thirty-six plastic ducts were cut to the correct length with tee joints for injecting the grout.

Formwork

Plywood formwork was used for the pile caps with proper supports. Holes were provided at the ends of the formwork to accommodate the cable ducts. The Navy subcontractor was responsible for building the formwork and the placement of reinforcements, ducts, and concrete.

Details of Ducts

Plastic tubes supplied by Carlon were used for the ducts. These plastic tubes, recommended for use inside the concrete for electrical duct work, were available in lengths of 100 ft. The tubes were cut to proper length so they projected 1 in. outside the formwork, which helped to apply the stoppers during the injection of resin (Figure 30). The ducts were cut in two pieces, joined at the center by a 1 in. x 3/4 in. plastic tee, and bonded with polyvinyl chloride (PVC) cement. A piece of 3/4 in. diameter PVC pipe was connected to this tee so it would project above the finished concrete surface (Figure 30). Half-inch electroplated metal tubes (EMT) were inserted through the ducts to keep them straight during concreting. The EMTs were removed after the concrete had cured. Stirrups made of CFRP fibers were used for shear reinforcement of the pile caps. The ducts and the stirrups were tied together with nonretractable plastic ties in order to place them into position.

The ducts with EMTs and stirrups were supported by a 4x4 wooden beam to keep the cage straight. After all the ducts, nonprestressed reinforcement, and stirrups were tied, the entire cage was lifted by crane with a 4x4 wooden beam and placed on the floor of the formwork. The top of duct system was supported with wires hanging from tie rods used for securing the side forms. The bottom of duct system was supported using chairs. The end formwork was fixed with ducts projecting outside.

Placement of Concrete

A 5000 psi (Type III cement) concrete with a slump of 2 1/2 in. was used to cast the pilecaps. Concreting was started at one end and needle vibrators were used to

compact the concrete. During concreting, six cylinders were cast to use in compressive strength testing. The pile caps were cured with wetted burlap and plastic sheets. The side and end formwork was removed after the concrete compressive strength reached 4000 psi (Figure 31).

Prestressing Operation

Temporary platforms were built at the two ends of the pile cap for the post-tensioning operation. Steel angle sections were fixed to the concrete beams by means of threaded rods holding the angles in position. The angles projected 2 ft from the ends of the pile cap. Wooden planks 1 in. thick were used between the angles to make the platform. Thick polyethylene sheets were used below the pile cap to collect any resin leak or dirt from the prestressing and grouting operations. Care was taken to prevent any accidental dropping of tools or waste material into the channel water.

Strain gages were mounted on concrete and E-glass/GFRP cables to monitor the strains during the prestressing operation. The cables were numbered from 1 to 12, starting at the bottom-left cable and numbered clockwise. Strain gages were mounted on the cables at 4 ft from the live end on cables 4 and 12 (Figure 32). Concrete strain gages were mounted on the sides at 3 in. from the bottom and 11 1/2 in. from the live end.

Cables were inserted, dead end first, through the plastic ducts (Figure 33). Rubber stoppers were drilled so the cables could pass through them. Another hole was drilled in these stoppers to allow air to escape during grout injection. Nails were used to plug the air holes after the grout injection. Two conventional steel chucks were used on the dead end and tube anchorage was used on the jacking end (Figure 32). A hydraulic jack was used to stress the cables in pairs (Figure 34). Each cable was prestressed to a jacking force of 16,000 lb. Strain gage readings and extensions were recorded during the prestressing operation to verify the prestressing force and the transfer loss. The ends of the ducts were plugged with rubber stoppers, then sealed further by injecting epoxy resin using a large syringe.

Grout Injection

Shell 815 resin and catalyst 'U' were used in 4:1 proportion by weight for the epoxy grout. This was the same resin used for the bridge project documented in Iyer 1991. This grout performed very well for the past 3 years in the bridge, so it was selected for this project. Small quantities were mixed using a mechanical vibrator and transferred to the injection unit. The grout was pumped through the flexible pipe

into the ducts at a pressure of 60 psi (maximum). Care was taken to control injection so the ducts were completely filled; workers monitored the resin trying to escape both ends through the nail holes in the rubber stoppers. When the ducts were filled, the pressure of the pumping unit was reduced to nearly zero and the holes were plugged with nails to prevent resin leakage. The level of resin raised in the vertical PVC pipes above the level of the concrete pile cap. The same procedure was used for the other 12 ducts. Leakage at the ends of the ducts was also monitored and checked (Figure 35).

Transfer of Prestressing Force

The resin was allowed to cure for 48 hours. After 48 hours, the cables were cut at both the ends using a circular saw. The split washers were used to reach the cable for cutting (Figure 36). The ends of the cables were then ground flush with the concrete surface. PVC tubes protruding at the top were also cut flush with the concrete surface. The bottom formwork of the pile caps was then removed.

Safety Precautions

All workers wore life jackets (flotation devices), hard hats, and safety glasses. Because the construction was over water, workers were instructed on all relevant safety measures. Special care was taken to avoid spilling resin into the ocean. Polyethylene sheets were attached to the bottom of pile caps to capture any resin leaks. Paper towels were used to clean up any leakage. After all the cables were grouted, the entire formwork for that pile cap was completely wiped with paper towels and acetone.

7 Pier Construction and Testing

Construction

The piles were installed on 20 foot centers per Figure 1. After initially jetting the pile into position (Figure 37), installation was completed using a diesel hammer. A pile driving analysis was performed during the initial driving of the piles on-site to establish the driving procedures and to verify load capacity of the pile. The pile caps were then installed across each row of piles as described in Chapter 6.

After the pile caps were completed and in place, the deck slabs were lifted into place by crane (Figure 38). The completed pier is shown in Figure 39. The pier construction is also cited in the literature by Iyer 1994.

Structural Performance Testing

The final step in construction was an *in situ* nondestructive structural performance test to verify performance and establish baseline performance data. An impact load method developed by NFSEC to test and evaluate their pier structures was selected (Warren 1993). This method uses a Falling weight deflectometer (FWD) to subject the structure to a calibrated dynamic load (Figure 40). The maximum force from the falling weight was 240 kN. The maximum dynamic deflection under the load is equivalent to the deflection that a static load of the same magnitude would produce.

During November 1994, a series of FWD tests was conducted. Figure 41 shows the results of nine tests performed at a midspan point on one of the deck slabs. The data points from each test virtually coincide with each other. A typical time history of the deflections shows, as expected, that there is very little load transfer from one deck slab to the other. The arrival time of the response is such that the stress wave must travel to the support and back rather than directly across the panels.

During October 1995 a second series of FWD tests was performed. The structure virtually had the same response (and therefore the same structural capacity) as approximately 11 months before.

Table 4. Summary of losses.

SI. No.	Type of loss	According to ACI (ksi)	According to AASHTO (ksi)
1	Creep	0.66	2.56
2	Shrinkage	0.64	5.0
3	Total	1.30	7.56

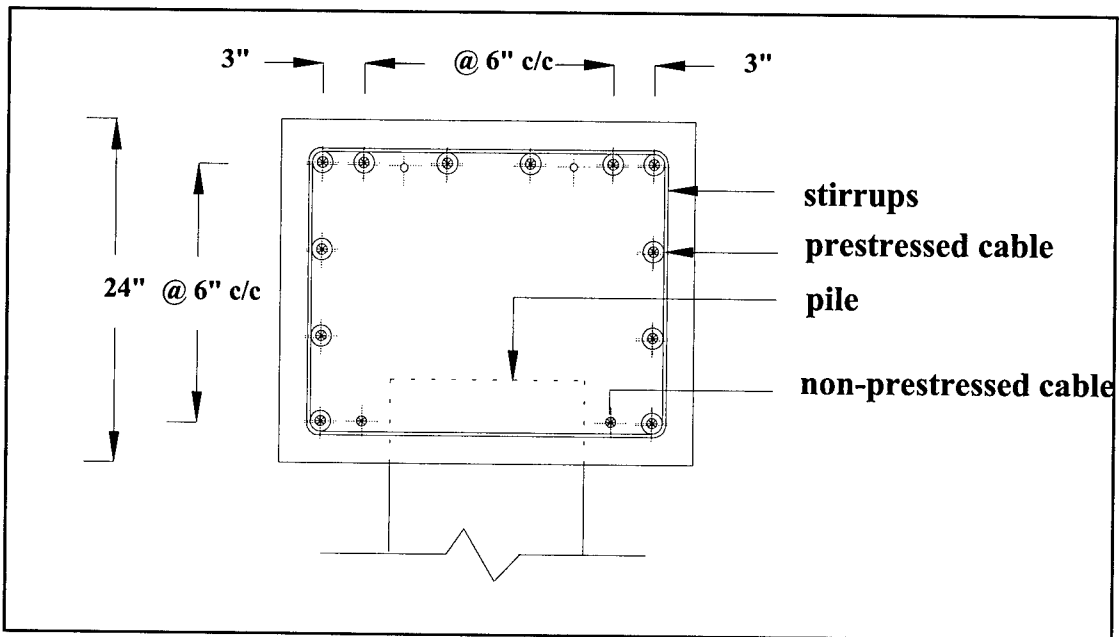

Figure 29. Cross-section of a pile cap.

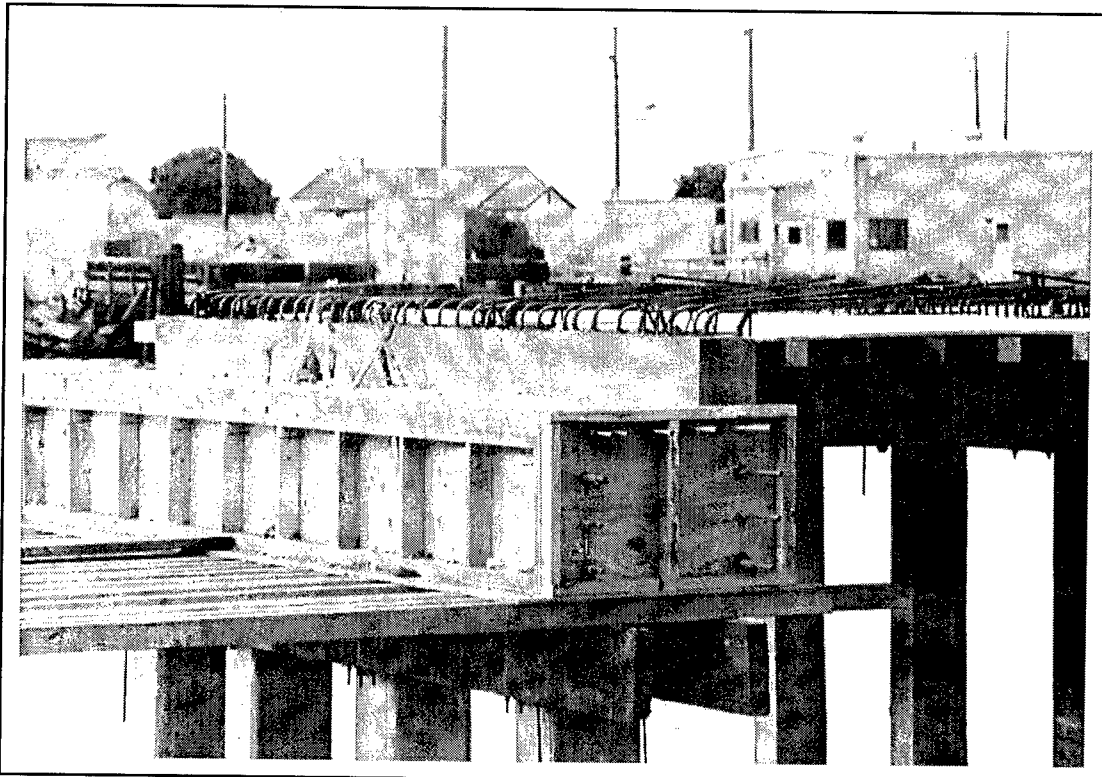

Figure 30. Ducts projecting outside the formwork and PVC tubes extending above the finished concrete surface.

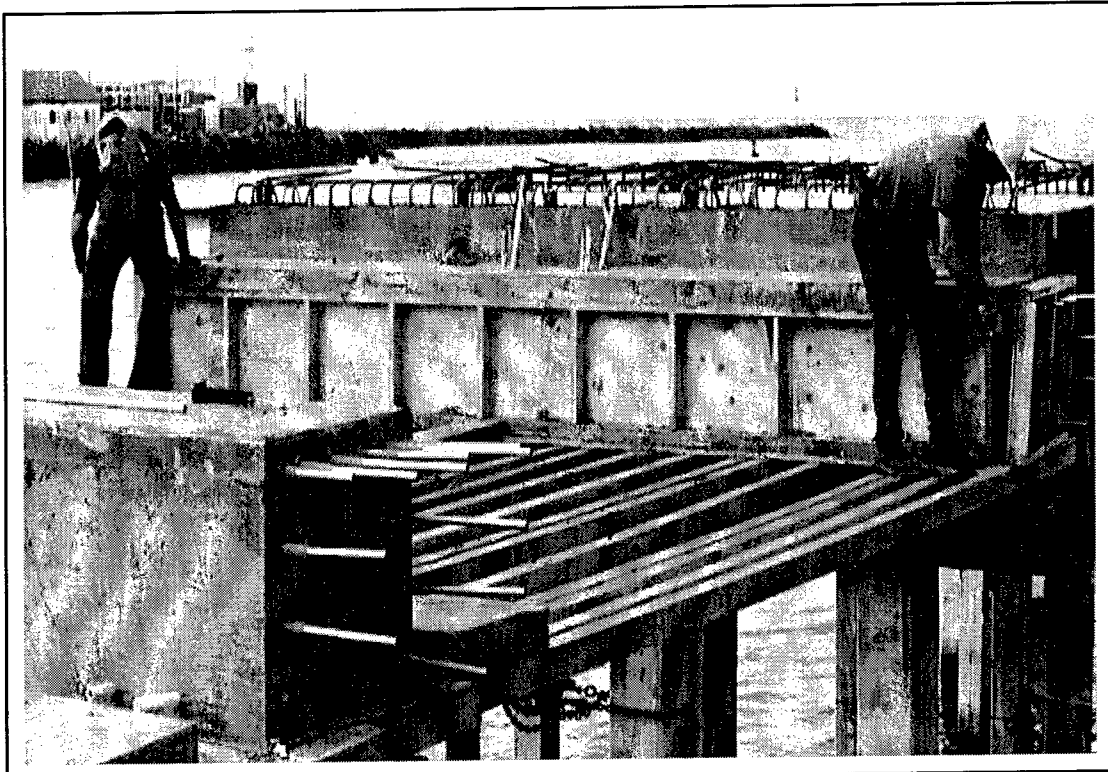

Figure 31. Side and end forms removed after concrete attained 4000 psi strength.

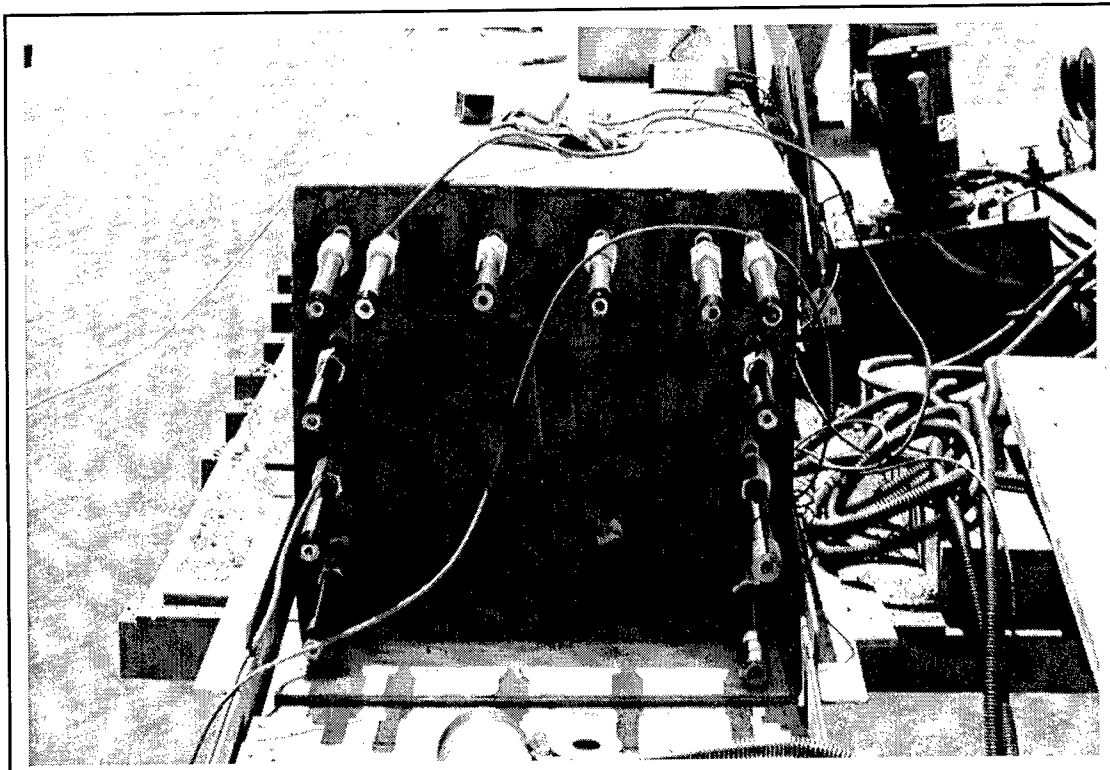

Figure 32. Tube anchorage on jacking end of GFRP cables.

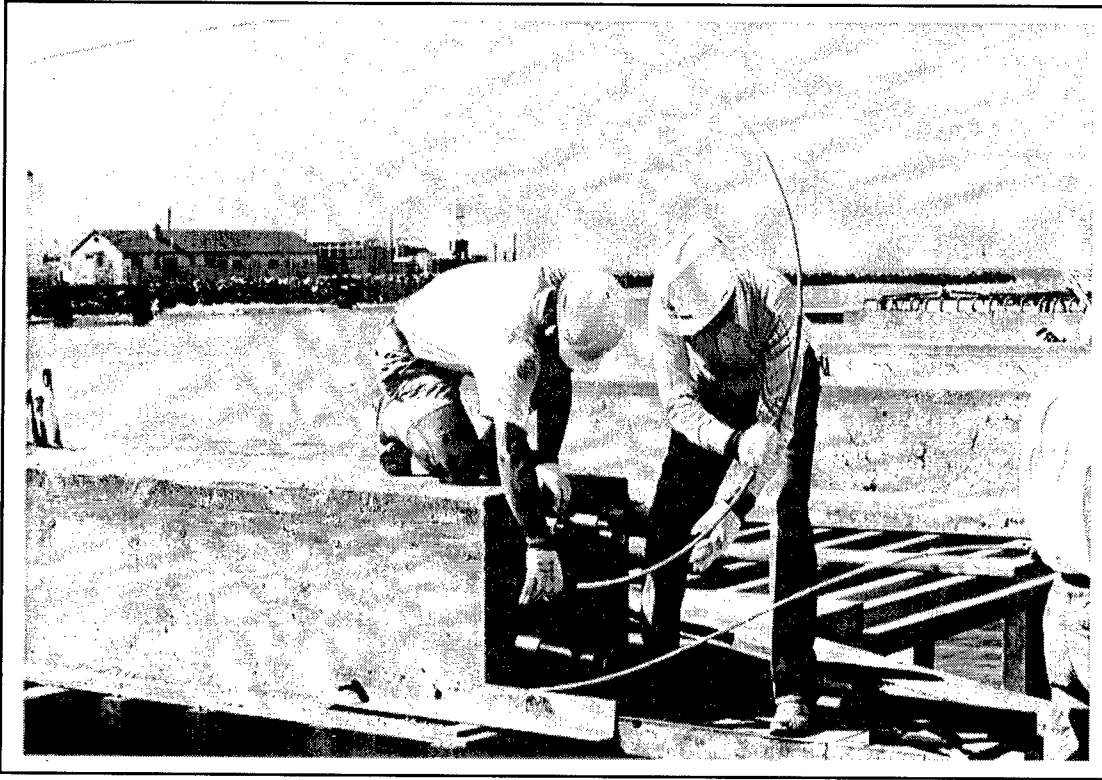

Figure 33. Inserting GFRP cables in the ducts.

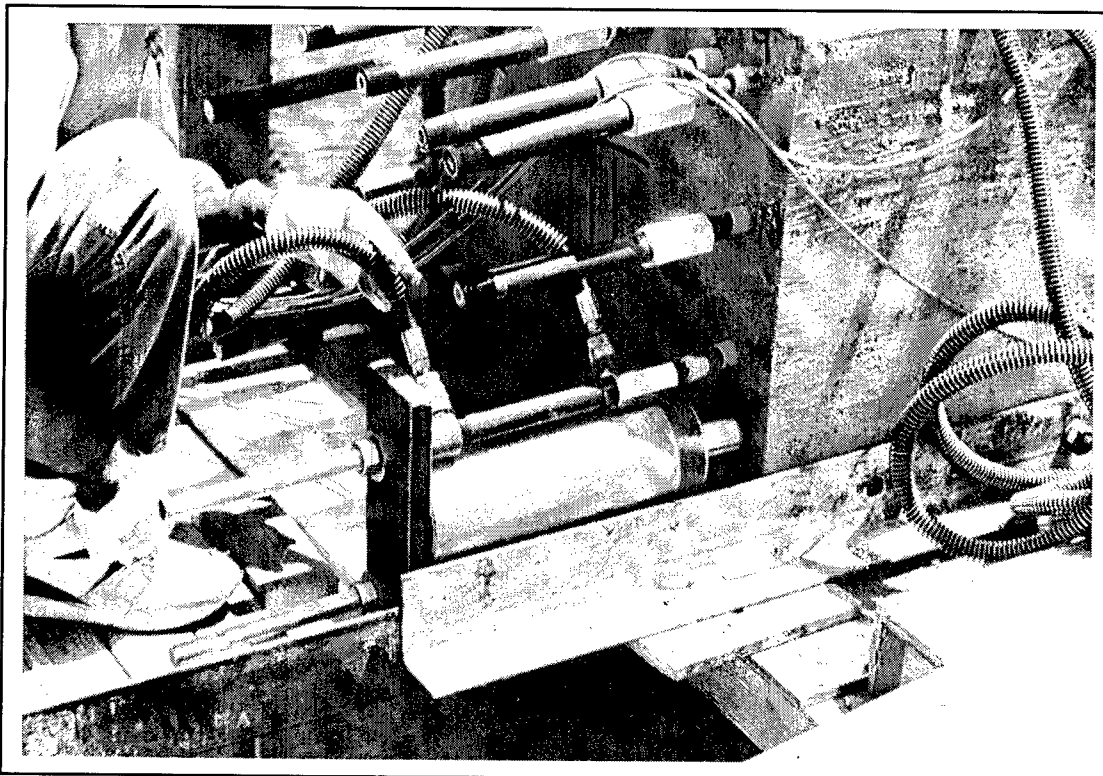

Figure 34. Two cables at a time pulled by the hydraulic.



Figure 35. Air pressure used to pump grout into the ducts.

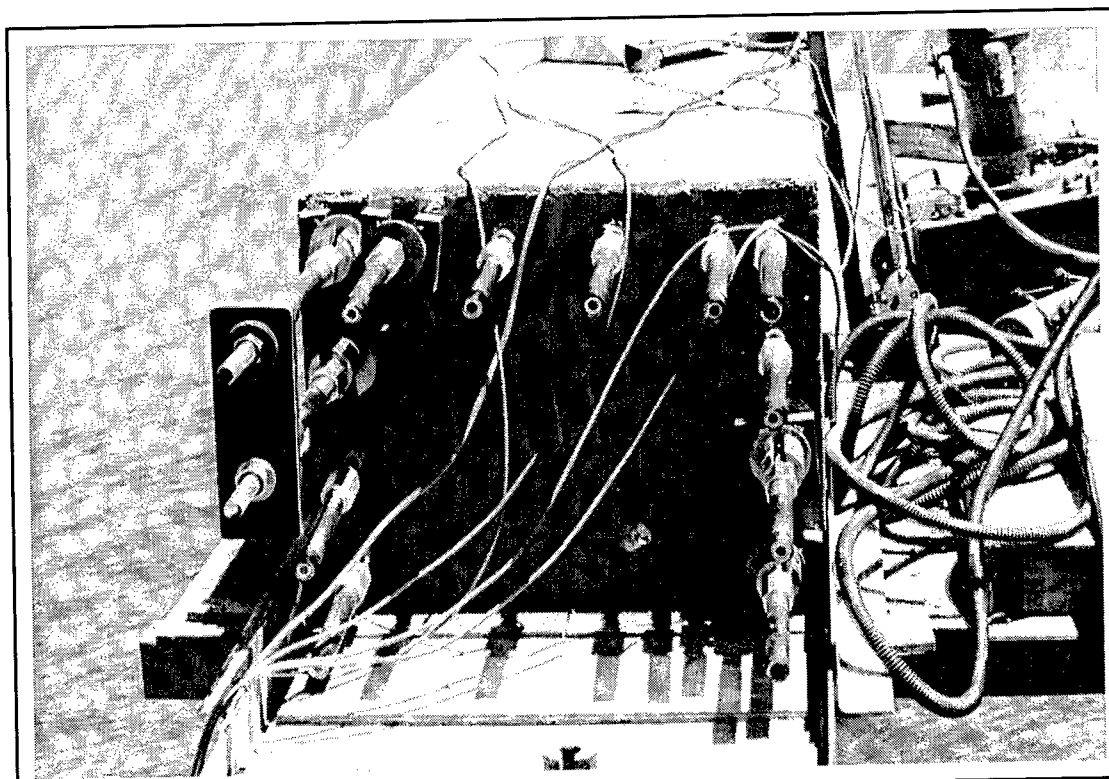

Figure 36. Stressing of cables in progress.

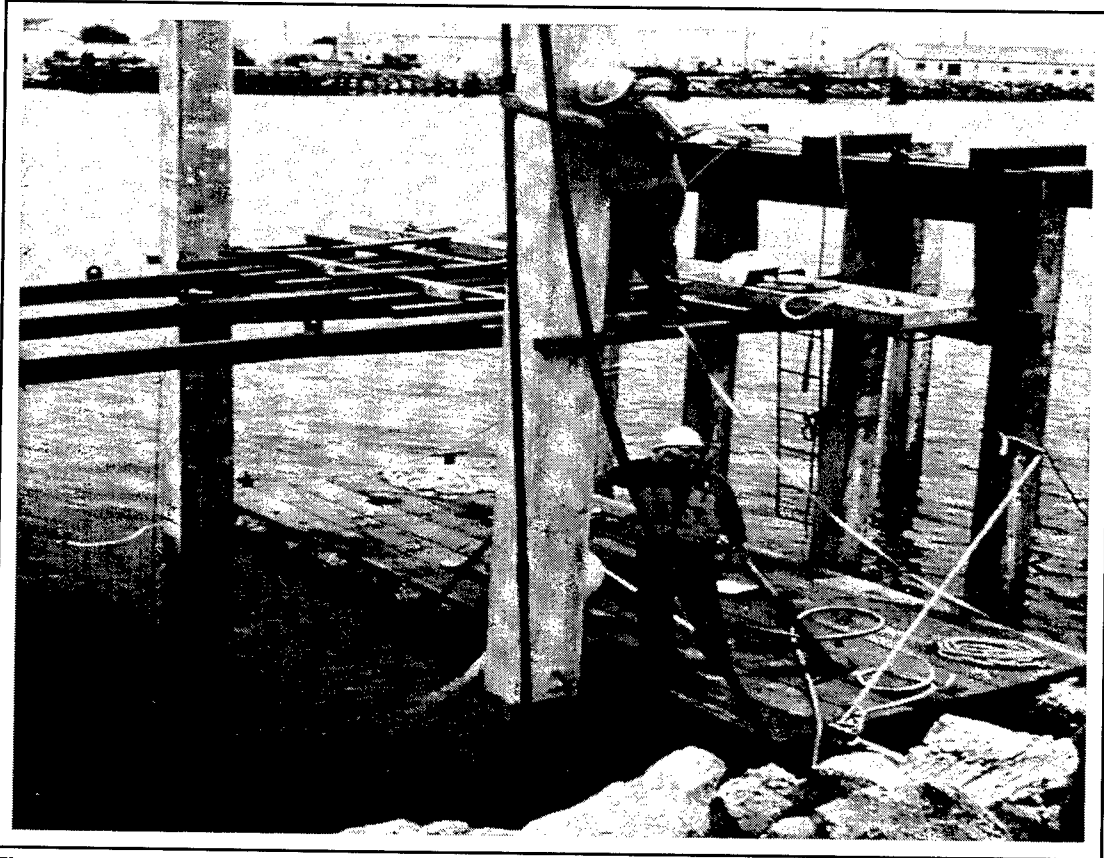

Figure 37. Piles being jetted into position prior to driving.

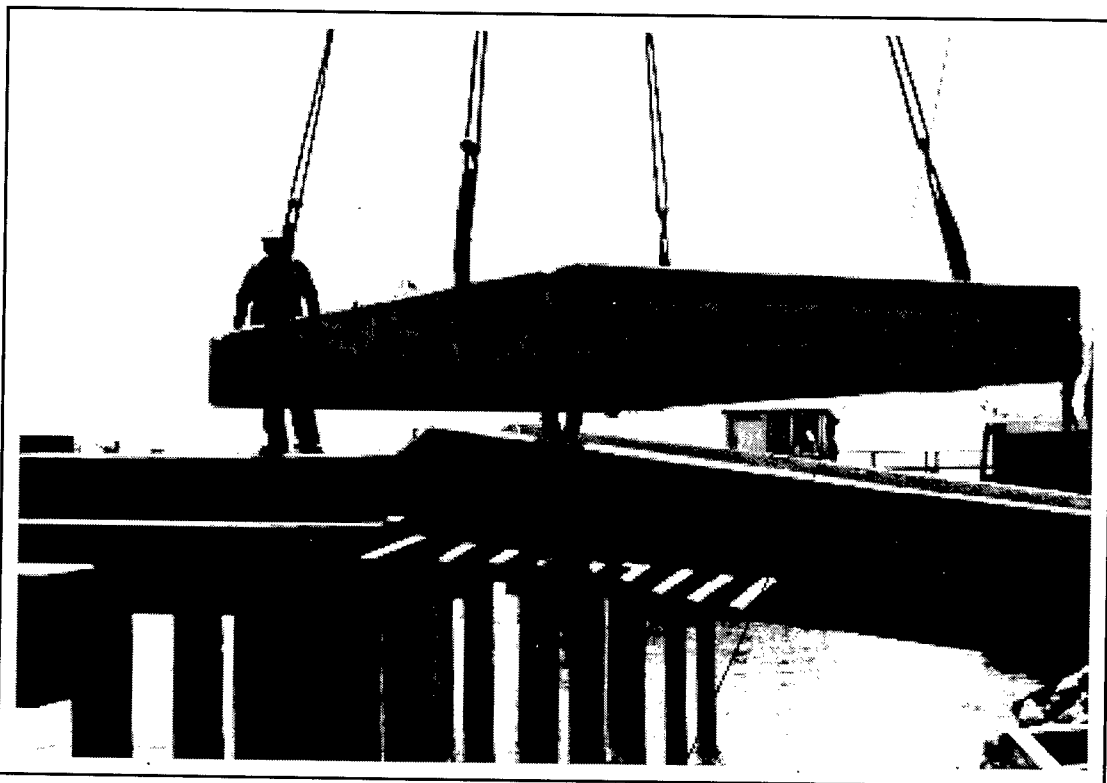

Figure 38. Deck slab being hoisted into place onto the pile caps.

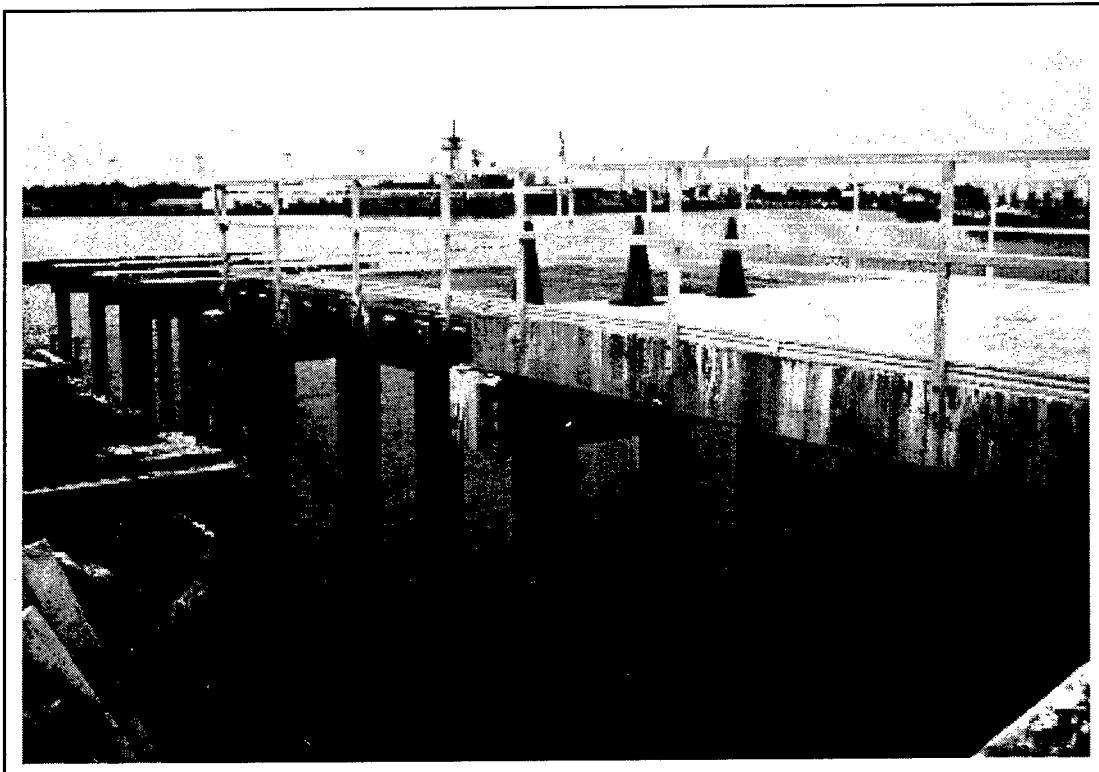

Figure 39. Overall view of the completed pier structure.

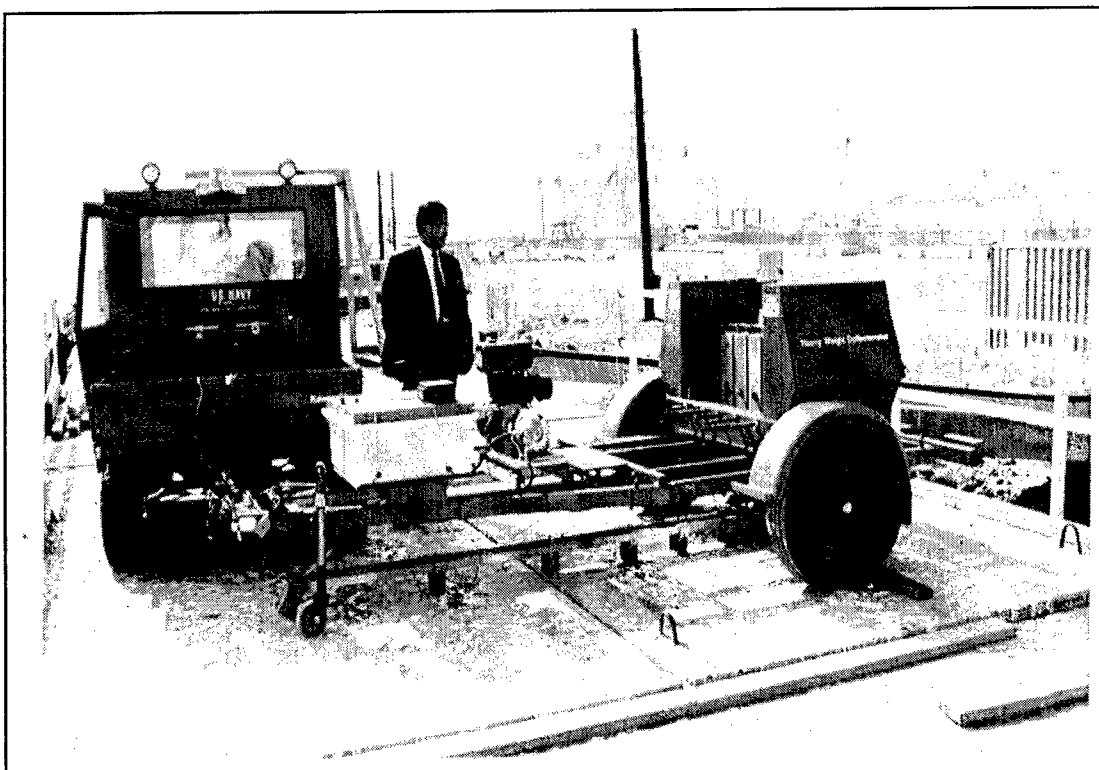

Figure 40. Falling weight deflectometer used in structural performance tests on the pier deck.

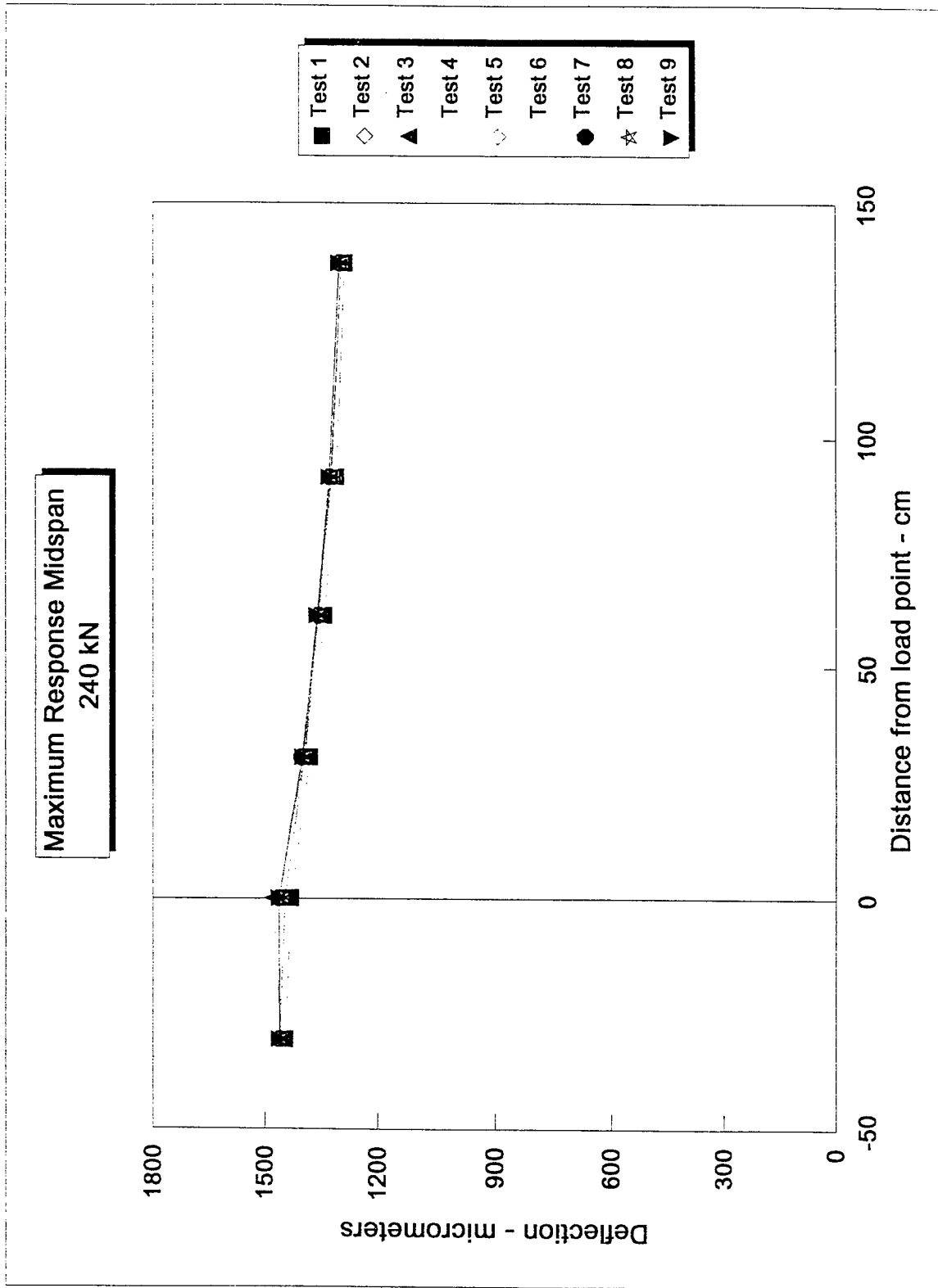

Figure 41. FWD test results, November 1994.

8 Design and Construction Guidelines

Design Philosophy

Properties of concrete and behavior in general with composite cables were the same as with steel cables.

The cable itself should satisfy the high tensile strength requirement and have a consistent modulus of elasticity in tension with a low relaxation. ACI and AASHTO codes were followed with composite cable properties, and CFRP and GFRP cables were used for this project.

Mechanical Properties of Cables

The ultimate tensile strength and modulus of elasticity of the cable material must be determined through proper testing. ASTM test methods were not available for testing composite cables during this project. SDSM&T developed test methods for composite cables before building the Rapid City, SD, bridge in 1991, and these test methods were used in the current project. Table 5 shows the properties of GFRP and CFRP. The E glass/GFRP cables were at par with 200 ksi steel cables, while CFRP cables were at par with 270 ksi steel cables. The nominal diameter of the composite cables was kept the same as 0.5 in. steel cable for purposes of easy manufacturing and substitution. Stress relaxation tests were conducted on the composite cables and the results are shown in Figures 42 and 43 (Sivakumar 1995). The initial decrease in strain was due to slippage of the anchorage and compliance of the test fixture. The results indicate that creep of the composite cables is not a serious problem using the developed design guidelines. Modulus of E-glass is about one-quarter that of steel, while the modulus of carbon is about three-quarters that of steel. Therefore, the composite cables were suitable for prestressing concrete in place of steel.

Development of Anchorages

Anchorages for the composite cables were developed at SDSM&T in 1991 and refined during the course of the two projects. These anchorages can be used for pretensioning operation with high reliability. Losses related to the anchorage due to slip were also studied, and the design values were developed for this project.

Design Guidelines

Four properties are most important when specifying composite cables to meet ACI or AASHTO standards for the design of prestressed concrete:

1. ultimate tensile strength of the cables
2. modulus of elasticity of the cables
3. creep or relaxation of the cables
4. slip values of the anchorage system during prestressing.

Values for each property are provided in Table 5 for E-glass/GFRP and CFRP cables, based on the findings of this CPAR project. These values can be used with proper verification by the user.

A jacking force, expressed as a percentage of the ultimate strength, was needed for the design (see Table 6). The designer also needed the transfer and development length on the basis of the experimental test results and the behavior of the structure. This information is provided in the Table 7.

Cable initial and final losses were calculated in this project by using ACI and AASHTO equations, but substituting the modulus of elasticity for composite cables in place of steel cables. The summary of various design values used for various components is shown in Table 6.

The design examples provided in Appendices C, D, and E of this report will help designers understand the details of the calculations, assuming that proper quality control and construction procedures are followed.

Construction Guidelines

Most concrete plants use good construction procedures for prestressing concrete with steel cables. This section highlights variations and additional information

needed to prestress concrete with composite cables. The construction guidelines provided here address both step-by-step construction procedures as well as quality control and safety of operations.

Handling of Composite Cables

Composite cables are subject to damage and need to be handled carefully during unloading, uncoiling, and handling. All sharp corners on steel molds must be covered with plastic tubes or plastic end plates. Workers must not walk over composite cables with steel boots or drop any heavy objects on the cables. The cables must not be bent beyond the recommended radius (generally 5 ft for CFRP cables and 4 ft for E-glass/GFRP cables).

Placement of Reinforcement in the Mold

All cables must be placed with care and initially stressed to 1000 lb to take the slack out in the cables. Spirals and shear reinforcements must be placed and spread carefully. Plastic ties should be used to keep them in position. Workers must not walk over the cables even if they are not fully stressed. CFRP cables are more subject to damage than GFRP cables.

Chucking the Cable Ends

The chuck or anchorage manufacturer's procedures must be followed completely. Steel chucks at the dead end of cables should be carefully positioned within the strengthened zone of the cable, and they must be inspected before stressing. The tube anchorage and cable length should be chucked to make sure there is enough room for the cable to extend for the full prestress. At least one cable should be chucked in the prestressing bed before starting the regular prestressing operation to make sure that the crew understands the procedure.

Other Considerations

- Initial stressing of 1000 lb should be carefully applied. A torque wrench can be used at the tube anchorage end, or the manufacturer's procedure may be followed.
- A thick tarpaulin should be placed over the molds to confine the fragments of cables if an accidental failure occurs. All the lifting devices should be in place before final stressing.
- The ends of the bed should be protected with solid shielding such as a steel plate or thick plywood, especially at the jacking end.

- Both jacking of the end plate for multiple cable stressing and single-cable stressing must be monitored properly for extension and applied force. Use an automatic shutoff for the hydraulic pump at maximum load.
- Keep all the tools and personnel off the line of prestressing and use remote control for operating the hydraulic jack.
- Remove tarpaulin sections for concreting (use super plasticizer for easy placement of concrete) and avoid hitting the cables with needle vibrators before there is any concrete in the mold.
- Other procedures, such as finishing, taking test samples, and curing are the same as for conventional prestressed concrete, with one exception: do not increase the temperature of concrete above 140 °F anytime during the curing operation.
- Use a remote-control circular saw with proper arm, body, and eye protection when cutting the composite cables. Do *not* use a torch or any similar device to cut the cables.
- Handling, stacking, shipping, and erection procedures are the same as for steel cable prestressed concrete.
- The ends of the cables can be ground using a circular grinder. The operator must wear proper protective glasses.
- The steel conventional chucks at the dead end can be reused as in the steel cable prestressing operations. However, the tube anchorage should be carefully burnt in an acceptable fashion and cleaned inside with steel brushes before being reused.

Cost of Different Cables

Several U. S. manufacturers are making GFRP and CFRP pultruded rods. Neptco, Inc, one of the Partner Participants in this project, is one such manufacturer. These pultruded rods are also used in many other engineering applications and the competition is growing in this field and prices are expected to fall as the sales volume increases. Price of the 0.157 in (4mm) rods per 1000 ft is as follows:

1000 ft of GFRP/E-glass rods of 195 ksi strength =	\$ 77
1000 ft of CFRP rods of 300 ksi strength =	\$230

Seven such rods are needed to make the prestressing cables. The cost of making the cables is as follows:

GFRP Cables

For 7 rods (0.157 in. diameter) in a GFRP cable, cost =	\$0.54/ft
Cost of making cable	<u>\$0.10/ft</u>
	Total = \$0.64/ft

CFRP Cables

For 7 rods (0.157 in. diameter) in a CFRP cable, cost =	\$1.61/ft
Cost of making cable	<u>\$0.10/ft</u>
	Total = \$1.71/ft

The weight of these materials are nearly one fifth of steel and hence cost comparison is made in lengths and the cost per 1000 ft of cable as shown below:

1000 ft of GFRP/E-glass cable to match with 200 ksi steel =	\$ 640
1000 ft of CFRP cable to match 270 ksi steel =	\$1710
1000 ft of 200 ksi steel cable =	\$ 250
1000 ft of 270 ksi steel cable =	\$ 350

Cost of anchorage depends on the length and type of anchorage. Generally, if the length is more than 80 feet, the cost of anchorage or strengthening will break even and will not be a significant cost.

Since the weight of the FRP composite cables is nearly one fifth of steel for the same length, the cost of shipping the composite cables would be approximately one fifth that of steel. No significant additional expenses are incurred in the construction phase except for the cost differential of the cables themselves. For example, the cost of 14 inch square, 65 foot long piles are used to illustrate that the total cost of the pile verses extra cost of the

CFRP cables. The cost differential in CFRP cables to steel cables, for one pile: \$890 minus 182 = \$708.

In a marine environment (Florida), steel prestressing cables started corroding in less than 10 years (Sen 1990) while CFRP cables are not expected to corrode for its full life of more than 50 years. Hence the life-cycle costs of piles reinforced with CFRP composite prestressing cables is more than one fifth of piles reinforced with steel prestressing cables. The same would be true of GFRP cables. This shows that there is more to comparing the economics of using the different cable materials than just the cost of the cables. The cost of the constructed facility must be considered as well as life-cycle costs. Even at current prices, the cost of the CFRP and the GFRP cables should not be a deterrent to their use considering the performance benefits they offer.

Table 5. Mechanical properties of FRP composite cables.

Type of cable	Ult. stress (ksi.)	Modulus of elasticity (Msi.)	Creep or relaxation	Slip of anchorage (in.)	Remarks
GFRP	195	7.7	---	0.051	Slip for 4 ft length 16,000 lb force
CFRP	270-294	21	---	0.058	Slip for 30 ft length 22,500 lb force

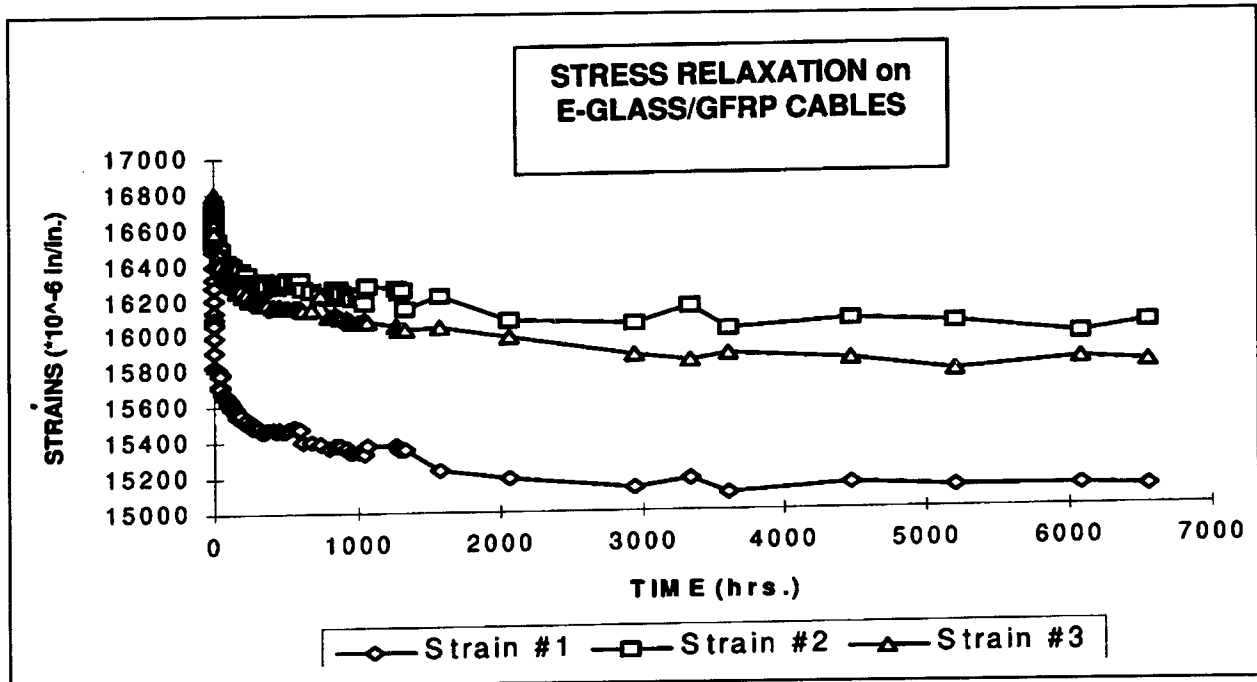

Figure 42. Creep test on E-glass/GFRP cables.

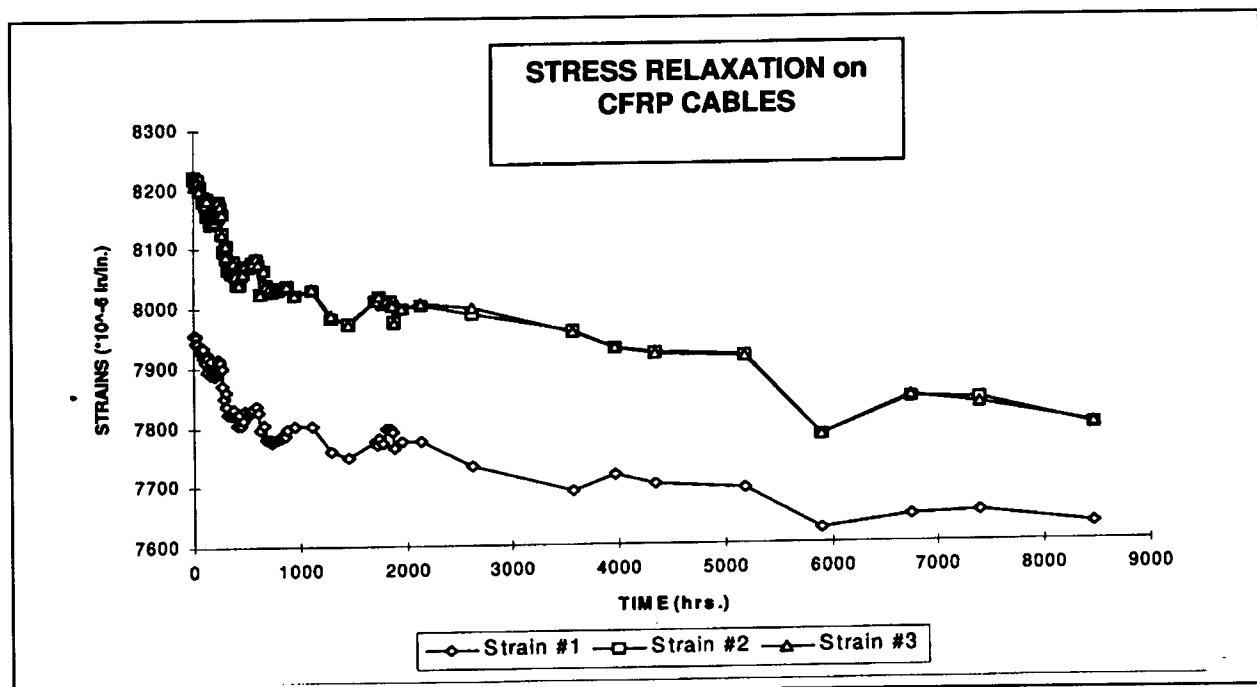

Figure 43. Creep test on CFRP cables.

Table 6. Summary of design parameters for various cables.

Length of the member for transfer loss	Material	Area of c/s (sq in.)	Ult. stress (ksi.)	Jacking stress	Prestress at transfer	Losses in prestressing			Final prestress	Modulus of elasticity (Msi.)
						Shrinkage of concrete (ksi.)	Concrete creep loss (ksi.)	Elastic shortening (ksi.)		
17 ft	Steel 1/2 in. dia.*	0.151	270	219 ksi. (0.81)	162 ksi. (0.60)	6.4	10.62	---	141.2 ksi. (0.523)	28.5
18 ft	GFRP 1/2 in. dia.	0.1304	195	123 ksi. (0.63)	117.8 ksi. (0.604)	5	2.56	---	110.24 ksi. (0.565)	7.5
80 ft	CFRP (for piles)	0.1338	270	149.5 ksi. (0.554)	146.51 ksi. (0.543)	5	9.6	4.2	127.71 ksi. (0.473)	21
30 ft	CFRP (for deck slab)	0.1338	270	168.2 ksi. (0.622)	164.84 ksi. (0.61)	5	17.32	7.58	134.94 ksi. (0.50)	21

* Values for steel shown here for comparison, and were determined for the post tensioned bridge deck in 1991 at SDSM&T.

Table 7. Transfer and development lengths.

Type of cable	Experimental		ACI		References
	Transfer length	Development length	Transfer length	Development length	
CFRP (7 rods of 0.125 in. dia.)	85db*	128db	48db	186db	Khubchandani 1991. Transfer length for unsanded CFRP cables at 144 ksi. (fse) and develop- ment length for sanded CFRP cables at 303 ksi (fps).
GFRP (7 rods of 0.113 in. dia.)	35db	120db	36db	102db	Feng 1991. Transfer length for GFRP cables at 103 ksi. (fse) and development length for GFRP cables at 170 ksi (fps).

*db is nominal diameter of bar.

9 Conclusions, Recommendations, and Commercialization

Conclusions

It is concluded that the design procedures and assumptions for prestressing losses used in the construction of the prestressed concrete pier structure were satisfactory. The composite prestressing system designed in this work met or exceeded all applicable ACI and AASHTO standards for steel-prestressed concrete structures. The carbon fiber reinforced polymer prestressing system used in the piles and deck slabs performed satisfactorily during fabrication, handling, driving, and testing; the GFRP prestressing system used in the pile caps also performed satisfactorily. The quality control in producing the rods, cables, and anchorages was fully effective. These conclusions are supported by: (1) the results of laboratory and field performance tests, (2) fabrication of the different composite cable components, (3) the construction of the demonstration pier, and (4) two rounds of structural performance testing on the completed pier structure.

The use of composite cables for the fabrication of the various pier components required only minor procedural changes. The cost of the composite prestressing cables is higher than steel cables. Even though the cost for composite prestressing materials was higher than for steel prestressing cables, this extra cost comprised only a small portion of total construction costs. It is expected that the long-term durability of the composite prestressing system will reduce the overall life-cycle cost of structures employing the system—especially in highly corrosive environments such as ocean shorelines.

It is concluded that this project clearly demonstrates the viability, practicality, and potential cost-effectiveness of using FRP composite cables in prestressed concrete structures subject to corrosive environments.

Recommendations

This demonstration project showed that a composite prestressed concrete pier could be constructed and remain structurally sound, with no visible deterioration, over a four year period since construction was completed. However, long-term performance can not be determined as part of a short-term project. Therefore, the pier structure should be, as long as NFESC (now the owner of the structure) has a use for the structure or the space it occupies is not needed for another application, periodically inspected. Ideally this would include periodic structural testing using the FWD.

An important issue to consider is that the pier structure constructed as part of this CPAR project is part of a Navy test facility and is not subjected to daily loads of people and equipment as would be an active pier. Additional construction projects using FRP composite prestressing cables are needed where the structure will see more continued use. Each such project should be documented and tech transferred to improve the industry's understanding of life-cycle and technical benefits of composite prestressing cables for the reinforcement of concrete. Other than the lack of specifications and design standards (which is addressed below), history of long-term performance is a major barrier to the more wide-spread use of composite cables for prestressing of concrete. Each new project using FRP composite prestressing cables will help bring an additional comfort level to their use and verify durability benefits.

Another major barrier to the use of new technologies (especially those that are structural components) within the construction industry is the lack of industry consensus material specifications and design/installation standards. To ensure that this technology becomes widely accepted in the U.S. civil engineering and construction communities, it is recommended that ACI, AASHTO, and ASTM take the lead in promoting industry consensus on material specifications, test methods, and design guidance (see Commercialization and Technology Transfer below). Before such consensus is developed, however, it is recommended that this technology be applied according to the design and construction guidelines summarized below.

Design Guidelines

1. Use ACI or AASHTO design procedures for the design of piles, pile caps, and deck slab, but substitute the modulus of elasticity for composite cables in place of the modulus for steel cables in all applicable design and engineering equations.

2. Consult the data for ultimate strength and the percentage of cable jacking stress, as presented in Table 6.
3. The manufacturer must fabricate the cables to include the required properties, but it is up to the project engineer to verify the properties for a particular application. The engineer also should check variations among material batches as part of a complete quality-assurance procedure.
4. The designer must be familiar with various material properties relating to concrete/cable interactions.
5. Chuck-slip losses depend on the type of anchorage used, and the manufacturer must provide these to satisfy the design assumptions.

Construction Guidelines

1. Except for the few changes noted in Chapter 4, procedures in the concrete prestressing plant should follow standard guidelines for steel-prestressed concrete.
2. Pretensioning is done in the plant while post-tensioning is done in the field. Fiberglass (E-glass) reinforced polymer composite cable was found to be economical from the standpoints of cost and the benefits of lower modulus for the short length required for the pile caps.
3. The duct system and the grout must meet the bonding requirements between the cable, grout, duct, and concrete. This aspect requires close attention during construction.
4. Epoxy grout with 60 psi pressure was satisfactory for the current project, but this specification may be changed for different cable diameters and different applications.
5. Sequence of stressing and destressing should be planned and executed carefully, especially for large sections such as a deck slab.
6. All safety precautions discussed in Chapters 4 and 6 should be followed.

Commercialization and Technology Transfer

Amoco Performance Products and Owens Corning are continuing to make the carbon and glass fibers with which the composite prestressing rods and cables were fabricated. Neptco, Inc. is producing a line of FRP composite rods and cables for prestressing applications. (Competing products from overseas are also now on the market.) Market penetration is expected to continue slowly, however, until standards become available and additional experience and history of performance is established. Besides the individual manufacturers involved in this project, the composites industry (through organizations such as the Composites Institute, New

York, NY) must assist in technology transfer and commercialization efforts of FRP composite prestressing elements. If not, overseas suppliers may proactively establish their own standards and control the market share for non-metallic prestressing systems.

Researchers and professionals with firsthand experience with this technology should promote further technology transfer through technical papers and presentations to industry groups, academia, and standards organizations. Both CPAR Principal Investigators have made presentations at technical conferences over the past several years (Iyer 1993; Lampo 1994, 1996).

As a result of this project and another related CPAR project on FRP composite rebars for concrete reinforcement (Trovillion 1997), the American Society of Testing and Materials (ASTM) established a new committee Section, D-20.18.01, "FRP Composites for Concrete Reinforcement." This ASTM Section is responsible for developing test methods and material standards for FRP composite used for the reinforcement of concrete. ACI Committee 440, "Fiber Reinforced Plastic Reinforcements," is working to develop design guidance for the use of FRP composites as concrete reinforcements. These two groups are cooperating closely to ensure consensus on the important materials parameters. The general use of FRP prestressing cables for concrete reinforcement, and this CPAR project in particular, are discussed in Corps of Engineers draft Engineering Technical Letter (ETL) 1110-2-548, "Engineering and Design - Composite Materials for Civil Engineering Structures," dated 31 March 1997.

References

- Anigol, M. U., "Testing and Evaluating Fiberglass, Graphite and Steel Prestressing Cables for Pretensioned Beams," M.S. Thesis, 1991, South Dakota School of Mines and Technology.
- "Carbon-Fiber Strands Prestress Calgary Span," *Engineering Journal*, October 1993, p 2.
- Engineering Technical Letter 1110-2-548, *Engineering and Design - Composite Materials for Civil Engineering Structures*, 31 March 1997.
- Feng, J., "Evaluation of Fiberglass Composite Cables for Prestressing Concrete," M.S. Thesis, 1991, South Dakota School of Mines and Technology.
- Gorty, S., "Evaluating the Mechanical Properties, Quality Control, Anchorage Slip, and Chuck Losses of E-Glass and Graphite Cables for Their Use in Prestressing," M.S. Thesis, 1994, South Dakota School of Mines and Technology.
- Iyer, S.L., "Advanced Composite Demonstration Bridge Project," Final Report to South Dakota Department of Transportation, December 1991.
- Iyer, S.L., and R. Sen, "Fiberglass Pretensioned Piles for Marine Environment," *Proceedings of the Specialty Conference of Advanced Composite Materials in Civil Engineering Structures*, January 31 and February 1, 1991, pp 132-142.
- Iyer, S.L., B. Vulcan, and R. Lampo, "Advanced Composite Waterfront Structure Construction at Port Hueneme, California", *Proceedings of the 39th International SAMPE Symposium*, April 1994.
- Iyer, S.L., and C. Kumaraswamy, "Performance Evaluation of Glass Fiber Composite Cable for Prestressing Concrete Units," *Proceedings of the 33rd International SAMPE Symposium*, March 1988.
- Khubchandani, A., "Evaluation of Graphite Composite Cables for Prestressing Concrete," M.S. Thesis, 1991, South Dakota School of Mines and Technology.
- Kumarasamy, C., "Performance Evaluation of Fiberglass Fiber Composite Cable for Prestressing Concrete Units," M.S Thesis, 1988, South Dakota School Of Mines and Technology.
- Lampo, R., S. Iyer, and D. Brunner, "Use of Advanced Composite Prestressing Cables in Concrete Waterfront Structures," *Proceedings of International Conference on Composites Engineering*, (ICCE/1), New Orleans, LA, August 1994.

- Lampo, R., D. Hoy, and R. Odello, "Field Performance of FRP Composite Prestressing Cables", *Proceedings of the 4th Materials Engineering Conference*, Washington, DC, ASCE, 1996.
- Ranganathan, V., "Precast Waterfront Deck Structure with Carbon Cable as Prestressing Element," M.S. Thesis, 1994, South Dakota School of Mines and Technology.
- Sivakumar, R., "Design and Construction of Prestressed Piles and Pile Caps with Advanced Composite Cables for Navy Pier," M.S. Thesis, 1995, South Dakota School of Mines and Technology.
- Sripathy, G., "Construction Phase of Advanced Composite Prestressed Bridge", Masters Thesis, 1992, South Dakota School of Mines and Technology.
- Sen, R., S. Iyer, M. Issa, and M. Shahawy, "Fiberglass Pretensional Piles for Marine Environment", *Proceedings of the Advanced Composites Materials in Civil Engineering Structures Conference*, Las Vegas, NV, ASCE, 1990.
- Trovillion, Jonathan C., H.V.S. GangaRao, S.V. Kumar, H.K. Thippeswamy, and L. Yoe, "Demonstration of Fiber-Reinforced Plastic Campsite Rebar on a Full-Scale Concrete Bridge Deck", Technical Report 97/119/ADA 331168 (USACERL, July 1997).
- Vedati, S.R., "Losses in Prestressing in Composite Cables," M.S. Thesis, 1994, South Dakota School of Mines and Technology.
- Vulcan, B., "The Construction Phase of the Advanced Composite Waterfront Structure," M.S. Thesis, 1994, South Dakota School of Mines and Technology.
- Warren, G.E., and L.J. Malvar, "Lateral Load Distribution in One Way Slabs," NCEL Technical Report, May 1991.
- Warren, G.E., and R. Shape, "Impact Load Method for Structural Assessment of Piers and Bridges," NCEL Technical Note N-1851, January 1993.
- "West German Bridge to Rely on Composite Tension cables (Polystal)," *Engineering News Record*, August, 1985, Vol. 215, p.11.
- Wines, J.C., and G.C. Hoff, "Laboratory Investigation of Plastic - Glass Fiber Reinforcement for Reinforced and Prestressed Concrete," Report 1, U.S. Army Waterways Experiment Station, U.S. Army Corps of Engineers, Vicksburg, MI, February 1966.
- Wines, J.C., R.J. Dietz, and J.L. Hawley, "Laboratory Investigation of Plastic - Glass Fiber Reinforcement for Reinforced and Prestressed Concrete," Report 2, U.S. Army Waterways Experiment Station, U.S. Army Corps of Engineers, Vicksburg, MI, July 1966.

Appendix A: Construction Productivity Advancement Research (CPAR) Program

CPAR is a cost-shared research and development (R&D) partnership between the U.S. Army Corps of Engineers (USACE) and the U.S. construction industry (e.g., contractors, equipment and material suppliers, architects, engineers, financial organizations, etc.) In addition, academic institutions, public and private foundations, nonprofit organizations, state and local governments, and other entities interested in construction productivity and competitiveness also participate in this program. CPAR was created by the Secretary of the Army to help the domestic construction industry improve productivity and regain its competitive edge nationally and internationally. This will be accomplished by enhancing USACE construction R&D programs with cost-shared industry partnerships. The objective of CPAR is to facilitate productivity-improving research, development, and application of advanced technologies through cooperative R&D programs, field demonstrations, licensing agreements, and other means of technology transfer.

The Federal Government is the largest single buyer of construction services. Technology advancements that improve construction productivity will reduce construction program costs. Projects not now economically feasible may become feasible due to lower construction costs. Such cost savings would accrue directly to the Federal Government's construction program, and would benefit the U.S. construction industry and the U.S. economy in general.

CPAR is intended to promote and assist in the advancement of ideas and technologies that will have a direct positive impact on construction productivity, project costs, and USACE mission accomplishments. R&D and technology transfer under CPAR is based on proposals received from educational institutions, the construction industry, and others that will benefit both the construction industry and the Corps of Engineers. The CPAR Program permits USACE to act on ideas received from industry, to cost-share partnership arrangements, and to rapidly implement successful research results through aggressive technology transfer and marketing actions. Section 7 of the Water Resources Development Act of 1988 (P.L. 100-676) and the Stevenson-Wydler Technology Innovation Act of 1980, as amended (15 U.S.C. 3710a *et seq.*) provide the legislative authority for the CPAR Program.

Appendix B: Literature Survey of Related Work

Laboratory Studies

The U.S. Army Corps of Engineers tried to develop an anchorage system for pultruded composite cables in the 1960's (Wines 1966). However, they were not successful in obtaining a satisfactory anchorage system. A feasibility study with GFRP cables for prestressing concrete was conducted at SDSM&T (Kumarasamy 1988). A strengthening method for anchoring the GFRP cables was developed at SDSM&T (Iyer 1988). Steel chucks were used on this strengthened end of the composite cables for anchoring the cables. Kumarasamy conducted tension tests on these cables to compare the modulus of elasticity and ultimate strength of S2™ GFRP (S2 glass is a trademark glass made by Owens-Corning Fiberglass Corporation.) composite cables with steel. Test methods were subsequently developed for testing GFRP and CFRP cables for their mechanical properties (Anigol 1991). He conducted static, short term sustained load, and cyclic tension tests on GFRP and CFRP cables. Long term sustained tension tests to determine creep in GFRP and CFRP cables at a stress level of 60 percent of the ultimate strength were conducted. No appreciable creep was detected in either of the cables.

Static flexure, short term sustained flexure and cyclic flexural tests on beams prestressed with GFRP cables were conducted at SDSM&T (Feng 1991). He designed slip critical and tension critical beams in order to establish transfer and development length of GFRP cables.

Static and cyclic flexural tests on beams prestressed with CFRP cables were conducted at SDSM&T (Khubchandani 1991). He tested slip critical and tension critical beams in order to establish transfer length and development length of CFRP cables. The same anchorage was used for prestressing concrete with bonded post-tensioning method (Sripathy 1992). He determined the transfer length for transfer of prestressing force and development length at ultimate tension failure of the cable.

Slipping of the chucks while prestressing the composite cables was studied at SDSM&T (Gorty 1994). He developed a standard set of tests to determine the mechanical properties of composite cables. He also studied creep on GFRP and CFRP cables using conventional anchorage. The creep measurement on the cables was not possible because of the continuous loss of stress due to slipping of anchorage. Several tests were conducted on different combinations of anchorages such as tube anchorage and steel chucks (Vedati 1994). The main objective of his study was to develop an anchorage system with the least losses due to transfer and anchorage slip. He also developed test methods to satisfy quality control and quality assurance for this CPAR project.

The Florida Department of Transportation in cooperation with the US Department of Transportation sponsored a 26 month study to investigate the feasibility of using GFRP as a replacement for steel cables in marine conditions (Iyer and Sen 1991). Flat slab pier design to distribute crane outrigger loads was studied by the Navy (Warren and Malvar 1991). This study found American Association of State Highway and Transportation Officials (AASHTO) procedures to be very conservative for patch loads on Navy piers. More efficient load distribution and high probability of shear failure mode has been suggested to liberalize the design relationship for effective width such as $E=0.5S$, $E < 10$ ft where E -effective width and S -Span of the slab.

Constructed Facilities

The first major bridge constructed using composite cable was built in Dusseldorf, Germany by Strabag Bayer (Engineering News Record August 1985). The city of Calgary, Canada is about to open a two span bridge where some of the girders were prestressed with CFRP composite cables (Engineering Journal October 1993).

A prestressed concrete bridge deck was built over steel girders to demonstrate the use of bonded post-tensioning method of prestressing with composite cables (Iyer 1991). Local consultants and contractors constructed this bridge using the techniques and design guidelines developed at SDSM&T. The bridge has a 30 ft span, 18 ft width and the prestressed slab was supported by three steel girders. Shear connectors were used for the composite beam action. The first 10 ft of the deck was prestressed with GFRP cables, the second 10 ft was prestressed with CFRP cables, and the last 10 ft was prestressed with steel cables in the transverse direction. Pretensioning method of prestressing the deck slab was not found economical for the 30 ft length as the prestressing frame might be very expensive

to build. Hence post tension method was used for all the types of cables with epoxy grout bonding.

Strict quality assurance of the materials was ensured by testing the cables for ultimate strength and modulus of elasticity from every batch of materials supplied by the manufacturers. Strain gages were installed on cables and concrete, and dial gages were mounted on the ends of the cables in order to measure strains and slip respectively. Deflections of the deck slab were monitored using dial gages. Photoelastic sheets were installed on the underside of the deck to monitor tension cracks. The bridge was tested at six salient positions using a self straining frame and a hydraulic jack to ensure the working stress and serviceability criteria before shipping to the site. Once the deck slab was installed in place, a standard truck was used to load the deck slab and check it for the same criteria. The measured strains and deflections were less than the allowable values according to the design. This bridge was monitored at regular intervals for the next three years. The performance is reported to be satisfactory with regards to strength and serviceability. The losses encountered while prestressing the composite cables using conventional anchorages were quite high. This was mainly due to the short span of prestressing. Hence, the efforts were redirected to develop another anchorage for reducing the transfer losses.

Appendix C: Design of Piles

This appendix deals with the losses used in the design of the pile based on ACI and AASHTO specifications.

C.1 Long Term Losses (According to ACI Equations)

1. Elastic shortening (ES)

$$ES = K_{es} \cdot E_g \cdot f_{cir} / E_{ci} \quad \text{ACI Eq. 4.1}$$

where $K_{es} = 1.0$ for pretensioned members

f_{cir} = stress at the centroid of the reinforcement = 0.8 ksi.

E_g = Modulus of CFRP cables 21 Msi.

$E_{ci} = 0.8 E_c$; E_c = Modulus of concrete = 4 msi.

$$ES = (1 \times 21 \times 0.755) / (0.8 \times 4) = 5.25 \text{ ksi.}$$

2. Creep Loss (CR)

$$CR = K_{cr} \cdot (E_g / E_c) \cdot (f_{cir} - f_{c,d,s}) \quad \text{ACI Eq. 4.3}$$

where $K_{cr} = 2.0$ for pretensioned members

$f_{c,d,s}$ = stress at centroid of reinforcement due to all permanent dead load applied after transfer of prestress = 0.

$$CR = \{ 2 \times 21 \times (0.8 - 0) \} / 4 = 8.4 \text{ ksi.}$$

3. Shrinkage Loss (SH)

$$SH = 8.2 \times 10^{-6} \times K_{sh} \times E_g \times (1 - 0.06 V/S)(100 - RH) \quad \text{ACI Eq. 4.4}$$

where $K_{sh} = 1.0$ for pretensioned members

V/S = area/perimeter ratio

RH = relative humidity factor (for California coastal areas = 80)

$$SH = 8.2 \times 10^{-6} \times 1 \times 21 \times 10^3 \left(1 - \frac{0.06 \times 12 \times 18}{2(12 + 18)} \right) (100 - 80) = 2.73 \text{ Ksi}$$

$$\text{Total Losses} = ES + CR + SH = 5.25 + 8.4 + 2.73 = 16.38 \text{ ksi.}$$

C.2 Long term Losses (According to AASHTO Specifications)

1. Elastic Shortening Loss (ES)

$$ES = (E_g / E_{ci}) f_{c1r} \quad \text{AASHTO 9.16.2.1.2 (Eq. 9.2)}$$

$$ES = (21 / 4) 0.8 = 4.2 \text{ ksi}$$

2. Creep Loss (CR)

$$CR = 12.f_{c1r} - 7.f_{cds} \quad \text{AASHTO (Eq. 9.3)}$$

$$CR = 12 \times 0.8 - 7 \times 0 = 9.6 \text{ ksi.}$$

3. Shrinkage Loss (SH)

$$SH = 17,000 - 150 \times RH \quad \text{AASHTO (Eq. 9.4)}$$

$$SH = 17,000 - 150 \times 80 = 5000 \text{ psi} = 5 \text{ ksi.}$$

$$\text{Total Losses} = ES + CR + SH = 4.2 + 9.6 + 5 = 18.8 \text{ ksi.}$$

Comparing with total losses according to ACI, losses based on AASHTO are higher.

Therefore maximum of the two was used in design.

$$\text{Therefore, percentage loss} = 18.8/149.5 = 12.57\%.$$

$$\text{Therefore, final stress} = 800 (1 - 0.1257) = 700 \text{ psi.} < 800 \text{ psi, OK}$$

C.3 Design of Spirals

Spirals were provided for the confinement of concrete and were designed on the basis of stiffness. CFRP spirals were designed to provide the same stiffness as the steel spirals in a traditional prestressed pile with steel cables and steel spirals. Equating axial stiffness of steel and CFRP spirals gives:

$$A_s \times E_s = A_g \times E_g$$

where,

$A_s = \Pi \times 0.2^2/4 = 0.0314 \text{ in.}^2$ (1/5 in. diameter steel rods are used in the traditional prestressed piles)

$E_s = 29 \text{ msi.}$ (modulus of steel)

$E_g = 8.91 \text{ msi.}$ (Modulus of carbon fiber impregnated with 815 resin system)

$$A_s \times E_s = A_g \times E_g$$

$$0.0314 \times 29 = A_g \times 8.91$$

$$A_g = 0.102 \text{ sq in.}$$

$$\times dg^2/4 = 0.102, dg = 0.36 \text{ in.}$$

3/8 in. diameter CFRP spiral with 815 resin system was used for the piles.

Appendix D: Design of Deck Slab

The deck slab was designed for a load of 225 kips distributed on 30 in. square area at the center.

D.1 Calculation of Depth Required

Width of the Slab	=	9 ft
Length of the slab	=	20 ft
Span of the Slab (C / C of the supports)	=	18.75 ft
Live load (Distributed over 30" square area)	=	225 kips.
Live load per foot width of slab	=	25 kips/ft.

$$\text{Live load moment } M_{l.1} = \frac{PL}{4}$$

$$\frac{25 \times 18.75}{4} = 117.2 \text{ ft. Kips.} = 1.4 \times 10^6 \text{ in. lb.}$$

$$f_{cb} = M/S_{xx}$$

Where

f_{cb} = allowable bending stress for concrete = 0.45 f_c'

ACI - 18.4.2

f_c' = Compressive strength of concrete = 5000 psi.

So, f_{cb} = 2250 psi.

$$2250 = \frac{1.4 \times 10^6}{(12 \times d^2 / 6)}$$

$$d = 17.64 \text{ in.} \approx 18 \text{ in.}$$

D.2 Calculation of Total Moment

Dead Load per foot width of slab (Assuming 18 in. depth of slab)

$$= (12 \times 18 \times 150) / 144 = 225 \text{ lb./ft.}$$

$$\text{Dead load moment } M_d = \frac{225 \times 18.75^2 \times 12}{8} = 0.12 \times 10^6 \text{ in. lb.}$$

$$\text{Total moment} = 1.52 \times 10^6 \text{ in. lb.}$$

D.3 Layout of cables

Assuming 10 cables per foot width of the slab and the initial prestressing force as 22,500 lb per cable. The following figure shows the cable arrangement per foot width of the slab.

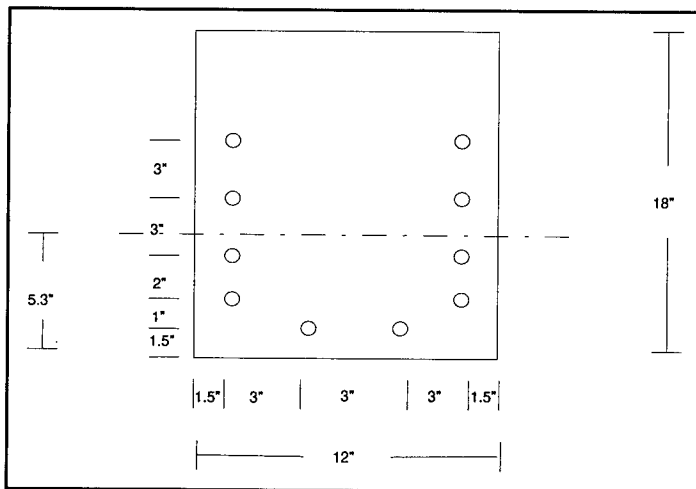

Figure D.1. Deck slab cross section.

Distance of the centroid from the bottom of the slab = 5.3in.

Eccentricity $e = 3.7$ in.

$$Z_{xx} = b.d^2/6 = 648 \text{ in.}^3$$

D.4 Short Term Losses

Transfer/Anchorage(After re-stressing)(Ranganathan 1994) = 2 %.

D.5 Initial Stresses

Initial prestressing force per cable = 22.5 kips.

Deducting 2 % for short term losses, the prestressing force = 22.05 kips.

$$\frac{P}{A} = \frac{22.05 \times 10}{12 \times 18} = 1.021 \text{ Ksi.}$$

$$\begin{aligned} \text{Initial stress on the top} &= \frac{P}{A} - \frac{P \cdot e}{Z_{xx}} + \frac{M_{d,l}}{Z_{xx}} = 1.021 - 1.259 + 0.185 \\ &= -0.053 \text{ Ksi (tension)} \end{aligned}$$

Initial stress on the bottom =

$$\frac{P}{A} - \frac{P \cdot e}{Z_{xx}} + \frac{M_{d,l}}{Z_{xx}} = 1.021 + 1.259 - 0.185 = 2.095 \text{ Ksi (compression)}$$

Initial expected stress = 2.095 ksi (Compression on the bottom)
= 0.53 ksi (tension on the top)

Stress at the centroid of reinforcement, $f_{c,ir}$ = 1.443 ksi.

At the time of laboratory testing, the long term losses have not taken place.

Hence at the time of testing :

$$\text{Live load for zero tension} = \frac{(2.095 + 0.053) \times 4 \times 648 \times 9}{17.5 \times 12} = 238.61 \text{ Kips.}$$

> 225 kips, OK

D.6 Long Term Losses (According to ACI Equations)

1. Elastic shortening

$$ES = K_{es} \cdot E_g \cdot f_{c,ir} / E_{ci} \quad \text{ACI Eq. 4.1}$$

where $K_{es} = 1.0$ for pretensioned members

$f_{c,ir}$ = stress at the centroid of the reinforcement = 1.32 ksi.

E_g = Modulus of CFRP cables 21 Msi.

$E_{ci} = 0.8 E_c$; E_c = Modulus of concrete = 4 Msi

$$ES = (1 \times 21 \times 1.443) / (0.8 \times 4) = 9.47 \text{ ksi.}$$

2. Creep Losses

$$CR = K_{cr} \cdot (E_g / E_c) \cdot (f_{c,ir} - f_{cds}) \quad \text{ACI Eq. 4.3}$$

where $K_{cr} = 2.0$ for pretensioned members

f_{cds} = stress at centroid of reinforcement due to all permanent dead load applied to all permanent dead load applied after transfer of prestress = 0.

$$CR = \{ 2 \times 21 \times (1.443 - 0) \} / 4 = 15.15 \text{ ksi.}$$

3. Shrinkage Losses

$$SH = 8.2 \times 10^{-6} \cdot K_{sh} \cdot E_g \cdot (1 - 0.06 V/S) \cdot (100 - RH) \quad \text{ACI Eq. 4.4}$$

where $K_{sh} = 1.0$ for pretensioned members

V/S = area/perimeter ratio

RH = relative humidity factor (for California coastal areas = 80)

$$SH = 8.2 \times 10^{-6} \times 1 \times 21 \times 10^3 \left(1 - \frac{0.06 \times 12 \times 18}{2(12 + 18)} \right) (100 - 80) = 2.7 \text{ Ksi}$$

$$\text{Total Losses} = ES + CR + SH = 9.47 + 15.15 + 2.7 = 27.32 \text{ ksi.}$$

D.7 Long Term Losses (According to AASHTO Specifications)

1. Elastic Shortening Losses

$$\begin{aligned} ES &= (E_g / E_{ci}) f_{cir} && \text{AASHTO 9.16.2.1.2 (Eq. 9.2)} \\ &= (21 / 4) 1.443 = 7.58 \text{ ksi} \end{aligned}$$

2. Creep Losses

$$\begin{aligned} CR_c &= 12 \cdot f_{cir} - 7 \cdot f_{cds} && \text{AASHTO (Eq. 9.3)} \\ &= 12 \times 1.443 - 7 \times 0 = 17.32 \text{ ksi.} \end{aligned}$$

3. Shrinkage Losses

$$\begin{aligned} SH &= 17,000 - 150 \times RH && \text{AASHTO (Eq. 9.4)} \\ &= 17,000 - 150 \times 80 = 5000 \text{ psi} = 5 \text{ ksi.} \end{aligned}$$

$$\text{Total Losses} = ES + CR + SH = 7.58 + 17.32 + 5 = 29.9 \text{ ksi.}$$

D.8 Summary of Long Term Losses

Sl. No.	Type of loss	According to ACI (ksi)	According to AASHTO (ksi)
1	Elastic Shortening	9.47	7.58
2	Creep	15.15	17.32
3	Shrinkage	2.7	5.0
4	Total	27.32	29.9

AASHTO procedure provided the maximum loss of 29.9 ksi.

D.9 Final Stresses After Long Term Losses

Area of one cable = 0.1338 in.²

29.9 ksi on cables = $(29.9 \times 0.1338) / 22.05 = 25.2 \%$

Final stress = $(1-0.252) \times (1.021 + 1.259) = 1.705$ ksi (compression)
 $= (1-0.252) \times (1.021 - 1.259) = 0.178$ ksi (tension)

Final stress with dead load of slab = $1.705 - 0.185 = 1.52$ ksi (compression) on the bottom.

$= 0.178 + 0.185 = 0.363$ ksi (tension) on the top.

Live load for zero tension = $\frac{(1.52 + 0.363) \times 4 \times 648 \times 9}{17.5 \times 12} = 209.17$ Kips.

Allowable tensile stress in concrete = $6\sqrt{f'_c} = 0.424$ Ksi (tension)

Live load for allowable tension =

$\frac{(1.52 + 0.363 + 0.424) \times 4 \times 648 \times 9}{17.5 \times 12} = 250.27$ Kips. > 225 kips, OK

D.10 Check for Shear

Total Live load = 225 kips.

Live load / ft width of the slab = 25 kips.

Maximum shear will occur when the live load is placed near one of the supports. Note that at the bottom of the slab, the load will be distributed over a width of 5.5 ft through the thickness of the slab.

Load of $25/5.5 = 4.54$ kips / ft acts over a width of 5.5 ft.

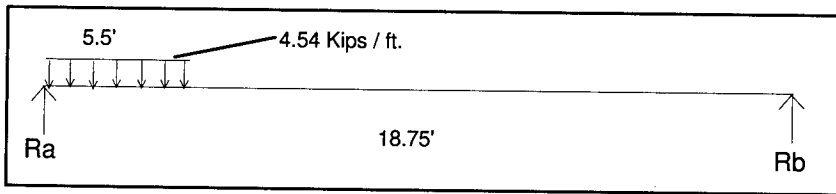

Figure D.2. Shear diagram.

$$R_a = 21.3 \text{ kips ;}$$

$$R_b = 3.7 \text{ kips ;}$$

Shear from dead load :

Dead load of the slab/ft. width = 0.225 kips/ft.

Shear due to dead load = $(0.225 \times 20) / 2 = 2.25$ kips.

Factored shear = $1.7 \times$ shear due to live load + $1.4 \times$ shear due to dead load

ACI 9.2.1

$$= 1.7 \times 21.3 + 1.4 \times 2.25$$

$$= 39.36 \text{ kips.}$$

Calculation of shear offered by concrete

$$V_c = \{ 0.6 \sqrt{f'_c} + 700 (V_u.d / M_u) \}.b.w.d$$

For prestressed members, the critical section will be at a distance of half the depth of the member from the face of the support. Thus, the critical section for shear will be at a distance of 9 in. from the face of the support or 24 in. from the center of the support.

ACI 11.1.3.2

So Shear due to live load = $21.3 - 4.54 \times 2 = 12.22$ kips

Shear due to dead load = $2.25 - 0.225 \times 2 = 1.8$ kips

Where $V_u =$ factored shear force = $1.7 \times 12.22 + 1.4 \times 1.8 = 23.294$ kips

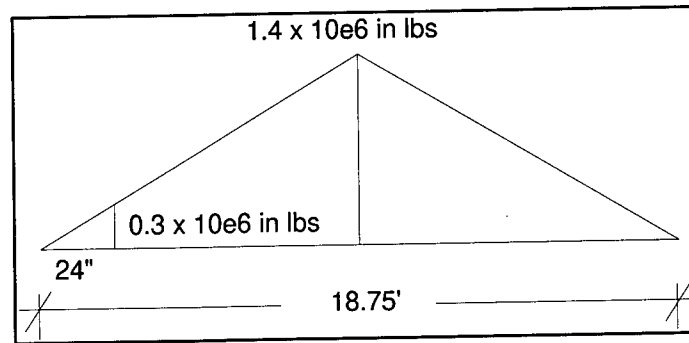

Bending moment Diagram

$$\begin{aligned} M_u &= \text{factored moment at 24 in. from the center of support} \\ &= 1.7 \times 0.3 \times 10^6 + 1.4 \times (2.25 \times 2 - 0.225 \times 2^2 / 2) \times 12 \\ &= 0.58 \times 10^6 \text{ in lb} \end{aligned}$$

$$\begin{aligned} d &= \text{distance of the centroid of prestressed reinforcement from} \\ &\quad \text{top compression fiber, but not less than } 0.8 h. \\ &= 12.7" < 0.8 \times 18 = 14.4"; \text{ So } d = 14.4". \end{aligned}$$

$$\frac{V_u \times d}{M_u} = \frac{23.294 \times 1000 \times 14.4}{0.58 \times 10^6} = 0.578$$

$$V_c = \{ 0.6 \sqrt{5000} + 700 \times 0.578 \} \times 14.4 \times 12 = 77,246 \text{ lb} = 77.25 \text{ kips.}$$

$$\begin{aligned} \text{But } V_c \text{ max} &= 5 \sqrt{f'_c} \cdot b_w \cdot d = 5 \sqrt{5000} \cdot 14.4 \times 12 \\ &= 61.1 \text{ kips.} \end{aligned}$$

ACI 11.4.1.

$$\begin{aligned} \text{For a safe design } V_u &\leq \phi \cdot V_n \text{ where } \phi = 0.85 \\ \phi \cdot V_n &= \phi \cdot V_c = 0.85 \times 61.1 = 51.935 \text{ kips} > 23.294 \text{ kips. Hence OK} \end{aligned}$$

ACI 9.3.2.3.

D.11 Design of Shrinkage and Temperature Reinforcement

Area of shrinkage and temperature reinforcement required =

$$\frac{0.0018 \times 60000}{f_y} = \frac{0.0018 \times 60000}{270 \times 10^3} = 0.0004 \quad \text{ACI - 7.12.2.1}$$

Minimum allowable = 0.0014

Gross Area of Reinforcement = $12 \times 18 \times 0.0014 = 0.3024 \text{ sq in. / ft.}$

Spacing of cables = $(12 \times 0.1338) / 0.3024 = 5.3" \approx 6"$.

Hence provide distribution reinforcement at 6 in. c/c bottom (along the width). At the top provide reinforcement in the form of a mesh, in both directions, at 6 in. c/c.

D.12 Deflection Calculations

Deflection due to prestressing force

$$\delta_p = \frac{M.l^2}{8.E.I}$$

where M = moment caused due to the eccentricity of prestressing force
 $= P.e = 10 \times 22.5 \times 3.7 = 832.5$ in kips.

$l = 20$ ft.

$$E = 57000\sqrt{f'_c} = 57000\sqrt{5000} = 4.03 \times 10^6 \text{ psi}$$

ACI 8.5.1.

I = moment of inertia per ft width = 5832 in.⁴.

So, $\delta_p = 0.255$ in. (upwards)

Deflection due to dead load

$$\delta_{d.l} = \frac{5.W_{d.l}.l^4}{384.EI}$$

Where $W_{d.l}$ = Dead load of the slab per ft width = 0.225 kips / ft

l = c/c distance of supports = 18.75 ft

So, $\delta_{d.l} = 0.026$ "

Deflection due to live load

$$\delta_{l.l} = Pl^3/48EI$$

Compressive strength of concrete on the day of testing (1-22-94) = 149,500 lb

Compressive stress = 5287.5 psi.

Weight of 6 in. x 12 in. cylinder = 28.82 lb

Unit weight of concrete $W_c = 28.82 / 0.192 = 150.10$ lb / cu in.

$$EC = 33\sqrt{W_c^3 \cdot f'_c} = 4.41 \times 10^6 \text{ in. lb}$$

ACI 8.5.1.

l = c/c distance of the supports = 18.75 ft

Live load per ft width of the slab = 225 / 9 = 25 kips / ft

$$\text{So, } \delta_{l.l} = \frac{25 \times 10^3 \times (18.75 \times 12)^3}{48 \times 4.41 \times 10^6 \times 5832} = 0.23" \text{ (downwards)}$$

Appendix E: Design of Pile Caps

E.1 Load Calculations

Assuming the cross section of pile cap as 30 in. width and 24 in. depth.

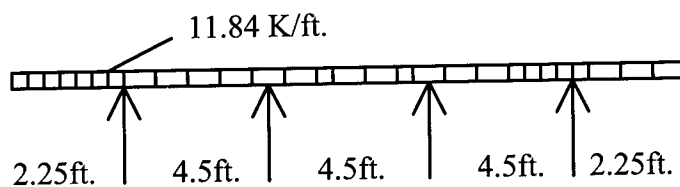

Longitudinal View of the 3 span pile cap

Assuming a 45 degree distribution, the load on pile cap will occupy a width of:

$$30 \text{ (width of loading area)} + 18 + 18 \text{ (depth of slab)} + 24 + 24 \text{ (depth of pile cap)} \\ = 114 \text{ in.} = 9.5 \text{ ft}$$

Load on pile cap is half of the total load = $225/2 = 112.5$ kips

Live load/ft. = $112.5/9.5 = 11.84$ K/ft.

Moment due to live load on cantilever portion = $w \times l^2/2 = 29.97$ ft kips.

Weight of slab per ft = $0.150 \text{ k/ft}^3 \times 1.5 \text{ ft} \times 10 \text{ ft} = 2.25$ K/ft.

Moment due to weight of slab = $2.25 \times 2.25^2/2 = 5.7$ ft kips.

Dead load of pilecap = $0.150 \text{ K/ft}^3 \times 2 \text{ ft} \times 2.5 \text{ ft} = 0.75$ K/ft.

Moment due to dead load of pile cap = $0.75 \times 2.25^2/2 = 1.9$ ft kips.

Total moment = $29.97 + 5.7 + 1.9 = 37.57$ ft kips

Total Shear = $(2.25 + 0.75 + 11.84) \times 2.25 = 33.39$ kips.

E.2 Section Properties

Initially, the 225 kips load was supposed to have any position on the deck slab. The worst stress situation would have been produced by placing the load over the pile cap. A bearing of 15 in. was required for each of the deck slabs on adjacent spans which brought the width as 30 in. The depth was arrived by the punching shear consideration from 14 in. x 14 in. pile for the 225 kips load. The

depth was computed as 24 in. However, the actual loading for this structure was later changed to be kept at the center of deck slab which would be less severe. But the over all dimensions of the pile cap were kept as indicated in the contract documents.

Area of pilecap, $A = 30 \times 24 = 720$ sq in..

Moment of inertia, $I = 30 \times 24^3/12 = 34560$ in⁴.

Section modulus, $S_{xx} = 30 \times 24^2/6 = 2880$ cu in.

E.3 Long Term Losses (According to ACI 318-R92 Equations)

1. Elastic shortening

$$ES = K_{es} \cdot E_g \cdot f_{cir} / E_{ci} \quad \text{ACI Eq. 4.1}$$

where $K_{es} = 0.5$ for post-tensioned members

f_{cir} = stress at the centroid of the reinforcement = 0.212 ksi.

E_g = Modulus of E-Glass/GFRP 7.7Msi.

$E_{ci} = 0.8 E_c$; E_c = Modulus of concrete = 4 Msi

$$ES = (0.5 \times 7.7 \times 0.212) / (0.8 \times 4) = 0.26 \text{ ksi.}$$

2. Creep Losses

$$CR = K_{cr} \cdot (E_g / E_c) \cdot (f_{cir} - f_{c,d,s}) \quad \text{ACI Eq. 4.3}$$

where $K_{cr} = 1.6$ for post-tensioned members

$f_{c,d,s}$ = stress at centroid of reinforcement due to all permanent dead load applied after transfer of prestress = 0.

$$CR = \{ 1.6 \times 7.7 \times (0.212 - 0) \} / 4 = 0.66 \text{ ksi.}$$

3. Shrinkage Losses

$$SH = 8.2 \times 10^{-6} \cdot K_{sh} \cdot E_g \cdot (1 - 0.06 V/S) \cdot (100 - RH) \quad \text{ACI Eq. 4.4}$$

where $K_{sh} = 0.85$ for post-tensioned members

V/S = area/perimeter ratio

RH = relative humidity factor (for California coastal areas = 80)

SH = 0.64 ksi.

Total Losses = ES + CR +SH = 1.56 ksi.

E.4 Long term Losses (According to AASHTO - Fifteenth Edition - 1992 Specifications).

1. Elastic Shortening Losses

$$\begin{aligned} ES &= (E_g / E_{ci}) f_{c1r} && \text{AASHTO 9.16.2.1.2 (Eq. 9.2)} \\ &= (7.7 / 4) 0.212 = 0.42 \text{ ksi} \end{aligned}$$

2. Creep Losses

$$\begin{aligned} CR_c &= 12.f_{c1r} - 7.f_{cds} && \text{AASHTO (Eq. 9.3)} \\ &= 12 \times 0.212 - 7 \times 0 = 2.58 \text{ ksi.} \end{aligned}$$

3. Shrinkage Losses

$$\begin{aligned} SH &= 17,000 - 150 \times RH && \text{AASHTO (Eq. 9.4)} \\ &= 17,000 - 150 \times 80 = 5000 \text{ psi} = 5 \text{ ksi.} \end{aligned}$$

Total Losses = ES + CR +SH = 8.0 ksi.

E.5 Summary of Long Term Losses

Sl. No.	Type of loss	According to ACI (ksi)	According to AASHTO (ksi)
1	Creep	0.66	2.56
2	Shrinkage	0.64	5.0
3	Total	1.30	7.56

Elastic shortening loss is included in the loss at transfer in post tension method. Maximum losses according to AASHTO specifications = 7.56 ksi was used for the design.

Area of cable = 0.1304 in^2

Percentage loss = $(7.56 \text{ ksi} \times 0.1304 \text{ in}^2) \times 100 / 16 = 6.16 \%$

The transfer loss (including elastic shortening) for 18 ft length of prestressing was determined to be 4% (14)

Total loss = $6.16 + 4 = 10.16\%$

E.6 Preliminary Design to arrive at number of cables

For zero tension,

$$P/A = M/S_{xx}$$

$$P = 37.57 \times 12 \times (720) / 2880 = 112.71 \text{ kips.}$$

Assuming the final prestress in a single cable to be 100 ksi,

Number of cables required = $112.71 / (100 \times 0.1304) = 8.64$, say 10 cables.

E.7 Layout of Cables

The layout of cables was determined from the practical considerations of accommodating the 6 in. projection of piles into the pile cap. No cables could be provided at the bottom middle portion of the pile cap. Hence an arrangement of cables worked out with the eccentricity to provide no tension due to prestressing. The minimum distance of 6 in. was required between the adjacent cables from the stand point of the size of jack and fixtures used in prestressing. Therefore an eccentricity of 3 in. (for the total force) was used with the following arrangement of 12 cables.

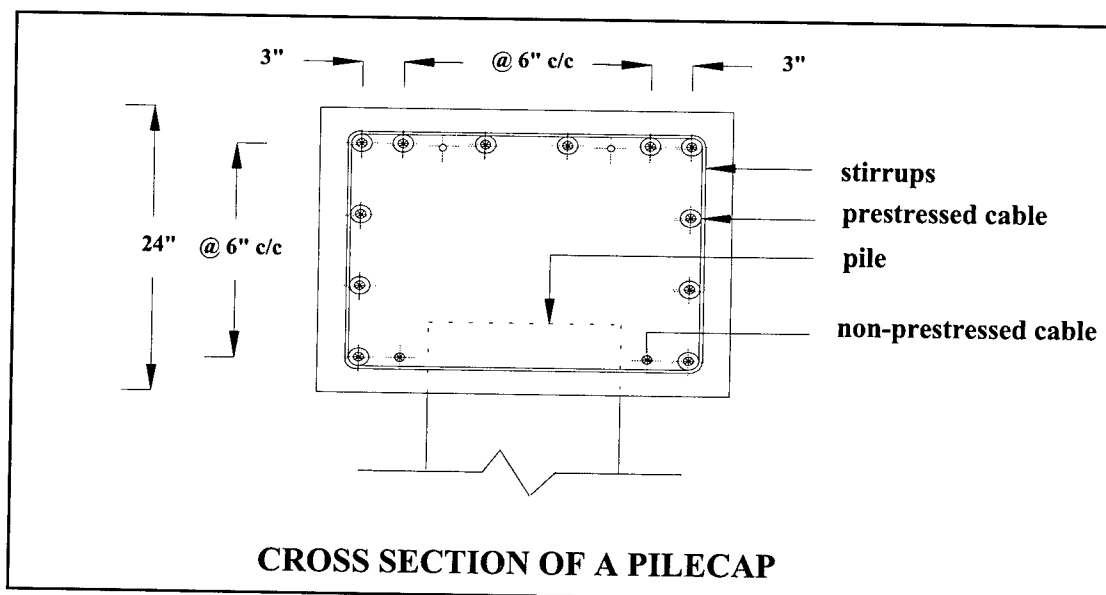

E.8 Initial & Final Stresses

ACI 318 code was used to check stresses at various steps of prestressing

Initial prestressing force per cable = 16 kips.

After a transfer loss of 4%(inclusive of elastic shortening),

Prestressing force in each cable = 0.96×16 kips = 15.36 kips

Strength of concrete at transfer = 4000 psi

Initial Stresses in concrete due to prestress and dead load of pile cap

$$P/A = \frac{15.36 \times 12}{24 \times 30} = 0.256 \text{ ksi}$$

$$A = 24 \times 30$$

$$P_{xe} = \frac{15.36 \times 3 \times 12}{2880} = 0.192 \text{ ksi}$$

$$S_{xx} = 2880$$

Bending stress due to dead load of pile cap;(Dead load moment = 1.9 ft kips)

$$M/S_{xx} = \frac{1.9 \times 12}{2880} = 0.008 \text{ ksi}$$

$$S_{xx} = 2880$$

$$\text{Initial stress at top} = 0.256 + 0.192 + 0.008$$

$$= 0.456 \text{ ksi. (compression)} < 0.6 \times f_{ci} = 0.6 \times 4.0 = 2.4 \text{ ksi, OK}$$

$$\text{Initial stress at bottom} = 0.256 - 0.192 - 0.008$$

$$= 0.056 \text{ ksi. (compression)} < 0.6 \times f_{ci} = 0.6 \times 4.0 = 2.40 \text{ ksi, OK}$$

Final Stresses in concrete after long term losses including prestress, dead load and live load moment

Prestressing force in each cable after long term losses = $(1 - .1016) \times 16 = 14.37$ kips

$$P/A = 14.37 \times 12 / 720 = 0.239 \text{ ksi}$$

$$P_{xe} = \frac{14.37 \times 12}{2880} = 0.059 \text{ ksi}$$

$$S_{xx} = 2880$$

Bending stress due to dead load of pile cap, dead load of deck slab, and live load;

Moment = 37.57 ft kips

$$\frac{M}{S_{xx}} = \frac{37.57 \times 12}{2880} = 0.156 \text{ ksi}$$

$$\begin{aligned} \text{Final stress (bottom)} &= 0.239 - 0.059 - 0.156 \\ &= 0.024 \text{ ksi. (compression)} < 0.45x f_c' = 2.250 \text{ ksi.} \\ \text{Final stress (top)} &= 0.239 + 0.059 + 0.156 \\ &= 0.454 \text{ ksi. (compression)} < 0.45x f_c' = 2.250 \text{ ksi.} \end{aligned}$$

Therefore, the stresses are not critical.

E.9 Design for Shear

Dead load shear = 6.75 kips.

Live load shear = $11.84 \times 2.25 = 26.64$ kips.

Maximum factored shear force = $1.4 \times 6.75 + 1.7 \times 26.64 = 54.74$ kips.

Shear offered by concrete = $5x\sqrt{f_c'}x b_w x d = 204$ kips. > 54.74 K, OK

Therefore, nominal shear reinforcement has to be provided.

Provide 3/8 in. diameter CFRP stirrups.

Spacing of Stirrups

Maximum allowable spacing is minimum of

- (a) $0.75 \times h = 18$ in.
- (b) 24 in.

Hence provide 3/8 in. diameter CFRP stirrups @18 in. c/c.

E.10 Deflection calculation for Pile Caps

1. Due to dead and live loads - Cantilever Portion

$$\delta = \frac{wl^4}{8EI}, \text{ where, } w = 2.25 \text{ K/ft} + 0.75 \text{ K/ft} + 11.84 \text{ K/ft} = 14.84 \text{ K/ft}$$

$$E = 4.00 \text{ msi, } I = 34560 \text{ in}^4.$$

$$\text{Therefore, } \delta = \frac{(14.84 \times 10^3/12) \times (2.25 \times 12)^3}{8 \times 4.0 \times 10^6 \times 34560}$$

$$\delta = 0.0006 \text{ in.}$$

Since the moment will be maximum in the cantilever portion the deflection will also be maximum only in the cantilever portion. Hence the above value can be taken as the maximum deflection in the pilecap.

Maximum allowable deflection for the cantilever = $l/1000 = 2.25 \times 12/1000 = 0.027 \text{ in.}$, OK

E.11 Calculation of Long Term Deflection

The immediate deflection can be multiplied by a factor
 $= \xi/(1+50 \cdot \rho')$

ACI Art 9.5.2.5

where,

ξ for 5 year period is 2

ρ' reinforcement ratio for non prestressed comp. reinforcement = $2 \times 0.1338/720 = 0.0004$.

Hence, $\lambda = 2.0/(1 + 50 \times 0.0004) = 1.96$.

Hence long term deflection = $0.0006 \times 1.96 = 0.0012 \text{ in.}$, OK

USACERL DISTRIBUTION

Chief of Engineers

ATTN: CEHEC-IM-LH (2)
ATTN: CEHEC-IM-LP (2)
ATTN: CECG
ATTN: CERD-M
ATTN: CECC-P
ATTN: CERD-L
ATTN: CECW-P
ATTN: CECW-PR
ATTN: CEMP-E
ATTN: CEMP-C
ATTN: CECW-O
ATTN: CECW
ATTN: CERM
ATTN: CEMP
ATTN: CERD-C
ATTN: CEMP-M
ATTN: CEMP-R
ATTN: CERD-ZA
ATTN: DAEN-ZCE
ATTN: DAIM-FDP

CECPW 22310-3862

ATTN: CECPW-E
ATTN: CECPW-FT
ATTN: CECPW-ZC

US Army Engr District

ATTN: Library (40)

US Army Engr Division

ATTN: Library (11)

CEWES 39180

ATTN: Library

CECRL 03755

ATTN: Library

CEWES 39180

ATTN: Library

CECRL 03755

ATTN: Library

Naval Facilities Engr Command

ATTN: Facilities Engr Command (8)
ATTN: Naval Civil Engr Service Center 93043

Nat'l Institute of Standards & Tech

ATTN: Library 20899

Defense Tech Info Center 22304

ATTN: DTIC-O (2)

Tennessee Valley Authority

Federal Highway Administration

US Bureau of Reclamation