

EPA-600/R-99-010

February 1999



PB99-128159

**METHANE EMISSIONS FROM  
THE U.S. PETROLEUM INDUSTRY**

**FINAL REPORT**

Prepared by:

Matthew R. Harrison  
Theresa M. Shires  
Richard A. Baker  
Christopher J. Loughran

Radian International LLC  
8501 N. Mopac Blvd.  
P.O. Box 201088  
Austin, Texas 78720-1088

EPA Contract No. 68-D2-0160  
EPA Project Officer: David A. Kirchgessner  
National Risk Management Research Laboratory  
Research Triangle Park, North Carolina 27711

Prepared for:

**U.S. ENVIRONMENTAL PROTECTION AGENCY**  
Office of Research and Development  
Washington, DC 20460

REPRODUCED BY: **NTIS**  
U.S. Department of Commerce  
National Technical Information Service  
Springfield, Virginia 22161



TECHNICAL REPORT DATA <i>(Please read Instructions on the reverse before comp)</i>		
1. REPORT NO. EPA-600/R-99-010	2.	PB99-128159
4. TITLE AND SUBTITLE Methane Emissions from the U. S. Petroleum Industry	5. REPORT DATE February 1999	
		6. PERFORMING ORGANIZATION CODE
7. AUTHOR(S) Matthew R. Harrison, Theresa M. Shires, Richard A. Baker, and Christopher J. Loughran	8. PERFORMING ORGANIZATION REPORT NO.	
9. PERFORMING ORGANIZATION NAME AND ADDRESS Radian International LLC P. O. Box 201088 Austin, Texas 78720-1088	10. PROGRAM ELEMENT NO.	
		11. CONTRACT/GRANT NO. 68-D2-0160
12. SPONSORING AGENCY NAME AND ADDRESS EPA, Office of Research and Development Air Pollution Prevention and Control Division Research Triangle Park, NC 27711	13. TYPE OF REPORT AND PERIOD COVERED Final; 4/95 - 4/96	
		14. SPONSORING AGENCY CODE EPA/600/13
15. SUPPLEMENTARY NOTES APPCD project officer is David A. Kirchgessner, Mail Drop 63, 919/541-4021.		
16. ABSTRACT The report quantifies methane (CH <sub>4</sub> ) emissions from the U. S. petroleum industry by identifying sources of CH <sub>4</sub> from the production, transportation, and refining of oil. Emissions are reported for the base year 1993 and for the years 1986 through 1992, based on adjustments to the base year calculations. An extensive literature search identified 54 reports as having some potential applicability for estimating CH <sub>4</sub> emissions from the petroleum industry. Each report was reviewed and subjectively ranked based on data quality. Only seven reports were useful for this study. Methods for estimating emissions were developed when data gaps were identified. For the base year 1993, approximately 98 billion (10 to the 9th power) standard cubic feet (Bscf) +/- 44% of CH <sub>4</sub> emissions are attributed to the petroleum industry. Standard error propagation techniques were used to determine the precision of the estimate to a 90% confidence bound. (NOTE: As concentrations of greenhouse gases increase in the atmosphere, their potential impact on global climate has become important. Although greenhouse gases, such as carbon dioxide (CO <sub>2</sub> ), CH <sub>4</sub> , and nitrogen oxides (NO <sub>x</sub> ), occur naturally in the atmosphere, recent attention has focused on the increased emissions resulting from human activities. CH <sub>4</sub> is the second largest source (after CO <sub>2</sub> ) of anthropogenic greenhouse gas emissions.)		
17. KEY WORDS AND DOCUMENT ANALYSIS		
a. DESCRIPTORS	b. IDENTIFIERS/OPEN ENDED TERMS	c. COSATI Field/Group
Pollution Methane Emission Petroleum Industry Greenhouse Effect	Pollution Control Stationary Sources	13B 07C 14G 05C 04A
18. DISTRIBUTION STATEMENT Release to Public	19. SECURITY CLASS (This Report) Unclassified	21. NO. OF PAGES 158
		22. PRICE
		20. SECURITY CLASS (This page) Unclassified

NOTICE

This document has been reviewed in accordance with U.S. Environmental Protection Agency policy and approved for publication. Mention of trade names or commercial products does not constitute endorsement or recommendation for use.

## ABSTRACT

As concentrations of greenhouse gases increase in the atmosphere, their potential impact on global climate has become an important issue. Although greenhouse gases, such as carbon dioxide (CO<sub>2</sub>), methane (CH<sub>4</sub>), and nitrogen oxides (NO<sub>x</sub>), occur naturally in the atmosphere, recent attention has been focused on the increased emissions resulting from human activities. Methane is the second largest source (after CO<sub>2</sub>) of anthropogenic greenhouse gas emissions. Because of the radiative properties of CH<sub>4</sub>, however, it is more effective at trapping heat in the atmosphere than CO<sub>2</sub>, and is therefore a more potent greenhouse gas. This report quantifies CH<sub>4</sub> emissions from the U.S. petroleum industry by identifying sources of CH<sub>4</sub> from the production, transportation, and refining of oil. Emissions are reported for the base year 1993 and for the years 1986 through 1992, based on adjustments to the base year calculations.

An extensive literature search identified 54 reports as having some potential applicability for estimating CH<sub>4</sub> emissions for the petroleum industry. Each report was reviewed and subjectively ranked based on data quality. Only seven reports were used for this study. Methods for estimating emissions were developed when data gaps were identified.

For the base year 1993, approximately 98 billion standard cubic feet (Bscf)  $\pm$  44% of CH<sub>4</sub> emissions are attributed to the petroleum industry. Standard error propagation techniques were used to determine the precision of the estimate to a 90% confidence bound.

## TABLE OF CONTENTS

	Page
ABSTRACT .....	iii
LIST OF TABLES .....	vi
LIST OF FIGURES .....	vii
1.0 EXECUTIVE SUMMARY .....	1
2.0 INTRODUCTION .....	4
2.1 PROJECT STRUCTURE .....	5
2.2 LITERATURE SEARCH .....	6
3.0 INDUSTRY EMISSION CHARACTERIZATION .....	8
3.1 SEGMENT DESCRIPTIONS .....	8
3.1.1 Production .....	10
3.1.2 Crude Transportation .....	10
3.1.3 Refining .....	10
3.2 EMISSION TYPES .....	10
3.2.1 Fugitive .....	12
3.2.2 Vented .....	12
3.2.3 Combusted .....	12
4.0 STATISTICAL METHODS .....	13
4.1 PRECISION .....	13
4.2 PROPAGATION OF ERROR .....	15
4.3 SCREENING FOR BIAS .....	18
5.0 ACTIVITY FACTORS AND EMISSION FACTORS—1993 BASE YEAR .....	20
5.1 ACTIVITY FACTORS - 1993 BASE YEAR .....	20
5.1.1 Production Rate and Well Count .....	20
5.1.2 Production Equipment Extrapolations from Site Visits .....	25
5.1.3 Miscellaneous Production Activity Factors .....	30
5.1.4 Crude Transportation .....	32
5.1.5 Refining .....	33
5.2 EMISSION FACTORS - 1993 BASE YEAR .....	36
5.2.1 Production .....	36
5.2.2 Crude Transportation .....	43
5.2.3 Refining .....	43
6.0 RESULTS—1993 BASE YEAR .....	46
6.1 PRODUCTION .....	46

## TABLE OF CONTENTS (Continued)

	<b>Page</b>
6.2 CRUDE TRANSPORTATION .....	48
6.3 REFINING .....	50
6.4 TOTAL INDUSTRY .....	52
7.0 METHANE EMISSIONS—1986-1992 .....	54
7.1 METHOD FOR HISTORICAL ESTIMATES .....	54
7.2 RESULTS .....	56
8.0 CONCLUSIONS .....	57
9.0 FUTURE EFFORTS .....	60
9.1 PRODUCTION SEGMENT KEY ISSUES AND ASSUMPTIONS .....	60
9.2 CRUDE TRANSPORTATION SEGMENT KEY ISSUES AND ASSUMPTIONS .....	62
9.3 REFINING SEGMENT KEY ISSUES AND ASSUMPTIONS .....	63
9.4 RECOMMENDED FUTURE TEST PLAN .....	63
9.4.1 Production Segment Improvements .....	64
9.4.2 Crude Transportation Segment Improvements .....	66
9.4.3 Refining Segment Improvements .....	66
10.0 REFERENCES .....	67
APPENDIX A - Results of Literature Search .....	A-1
APPENDIX B - Site Data .....	B-1
APPENDIX C - Statistical Analysis .....	C-1
APPENDIX D - Hypothetical Examples of Extrapolation and Bias .....	D-1
APPENDIX E - Production Fugitive Emission Factors .....	E-1
APPENDIX F - Tank Flash Calculations .....	F-1
APPENDIX G - English/Metric Conversions .....	G-1
APPENDIX H - Methane Emissions 1986-1992 .....	H-1

## LIST OF TABLES

	<b>Page</b>
1-1 1993 Methane Emissions From The U.S. Petroleum Industry .....	2
2-1 Ranking Of Emission Factor Data Quality .....	6
2-2 Ranking Of Activity Factor Data Quality .....	7
4-1 Error Propagation For Addition .....	16
4-2 Error Propagation For Multiplication .....	16
4-3 Error Propagation For Division .....	17
4-4 Values For Example Calculation .....	17
4-5 Errors For Addition, Multiplication, And Division Of Example Problem .....	17
5-1 1993 Activity Factors By Segment .....	21
5-2 Ratio Of Heavy Crude Production to Total Crude Production .....	24
5-3 Ratio Of Heavy Crude Production Wells To Total Crude Production Wells .....	25
5-4 Extrapolated Activity Factor Development .....	27
5-5 Production Extrapolation Parameter Selection .....	28
5-6 Comparison Of Sample Set To National Values .....	29
5-7 Final Production Developed Activity Factors .....	30
5-8 Refinery Throughputs .....	33
5-9 1993 Refinery Energy Requirements .....	35
5-10 1993 Refinery Fuel Consumption .....	35
5-11 Emission Factor Summary .....	37
6-1 1993 Methane Emissions Estimate Petroleum—Production .....	47
6-2 1993 Methane Emission Estimate Petroleum—Crude Transportation .....	49
6-3 1993 Methane Emission Estimate Petroleum—Refining .....	51
6-4 1993 Petroleum Methane Emission Estimate—Total Of Three Industry Segments .....	52
7-1 Refinery Engine Activity Factor For 1986-1993. ....	55
7-2 Emission Summary For 1986-1993 .....	56
8-1 Annual Methane Emission Estimates For U.S. Petroleum Industry From Five Different Studies (Bscf) .....	58



## LIST OF FIGURES

	<b>Page</b>
1-1 Sources of Methane Emissions (Including Results From This Study) .....	2
2-1 Sources of Methane Emissions (Previous Studies) .....	4
3-1 Petroleum Industry Segments .....	9
3-2 Industry Boundaries .....	11
6-1 Production Segment Largest Emission Sources .....	46
6-2 Crude Transportation Segment Largest Emission Sources .....	48
6-3 Refining Segment Largest Emission Sources .....	50
6-4 Emissions by Type .....	52
6-5 Percent Emissions by Segment .....	53
8-1 Sources of Anthropogenic Methane Emissions (Updated) .....	57



## 1.0 EXECUTIVE SUMMARY

As concentrations of greenhouse gases increase in the atmosphere, their potential impact on global climate has become an important issue. Although greenhouse gases, such as carbon dioxide (CO<sub>2</sub>), methane (CH<sub>4</sub>), and nitrogen oxides (NO<sub>x</sub>) occur naturally in the atmosphere, recent attention has been focused on the increased emissions resulting from human activities.

Methane is the second largest source (after CO<sub>2</sub>) of anthropogenic greenhouse gas emissions.<sup>1</sup> Because of the radiative properties of methane, however, it is more effective at trapping heat in the atmosphere than carbon dioxide, and is therefore a more potent greenhouse gas. U.S. anthropogenic methane emissions have three principal sources: emissions from the fuel cycle of fossil fuels (from production through end use of natural gas, coal, and oil), landfills, and livestock. This report estimates methane emissions from the U.S. petroleum industry by identifying sources of methane emissions from the production, transportation, and refining of oil. Emissions are reported for the base year 1993 and for the years 1986 through 1992, based on adjustments to the base year calculations.

The goal of this report was to identify the relative magnitude of the emissions from the petroleum industry, and to identify the likely major sources in the industry. A driving force for this report was the detailed analysis presented in the report, *Methane Emissions from the Natural Gas Industry*.<sup>2</sup> The natural gas industry study measured and analyzed methane emissions at an equipment level of detail, and therefore was more accurate than previous approximations for the gas industry. Although that report set a precedent of detail and accuracy, the scope of this preliminary estimate for the petroleum industry was more rudimentary.

The estimated magnitude of petroleum industry emissions presented in this report meets the initial objectives of a multi-phase approach. This Phase 1 report is limited to analysis of existing data and studies, and gathered no new field data. Since some of the existing data are extracted from other industries or have other limitations, the estimates produced in this Phase 1 report should be used only as a guideline for future efforts. Subsequent efforts, which have not yet been initiated, will further refine the estimate by gathering segment activity factors and directly measuring petroleum segment field data based on a statistically representative sampling approach.

This Phase 1 project used the latest available data from published reports and site measurement efforts. An extensive literature search identified 54 reports as having some potential applicability for estimating methane emissions for the petroleum industry. Each report was reviewed and subjectively ranked based on data quality. Only seven reports from the initial literature search were used for this study. Methods for estimating emissions were developed when gaps were identified.

This report estimates that 98 billion standard cubic feet (Bscf) of methane emissions are attributed to the petroleum industry for the base year 1993. This estimate is believed to be accurate to approximately +/- 100%. While precision of the estimate for 90% confidence bounds

was calculated to be only +/- 44% (see Section 6.0), there may be some unquantified biases resulting from use of the limited data set. Possible contributors to bias are listed in Section 4.3 and Section 9.0 of this report. These biases can be ruled out or corrected in future efforts.

The relative emissions from each segment of the petroleum industry considered in this study are shown in Table 1-1. The production segment accounts for the majority of methane emissions. Its largest sources are oil tank venting, pneumatic devices, chemical injection pumps, and fugitive emissions from large compressors.

TABLE 1-1. 1993 METHANE EMISSIONS FROM THE U.S. PETROLEUM INDUSTRY

Segment	Annual Emissions, Bscf
Production	87 ± 48%
Crude Transportation	1.4 ± 85%
Refining	9.2 ± 69%
TOTAL	98 ± 44%

Figure 1-1 illustrates how these emissions compare with other anthropogenic sources of methane emissions in the United States.

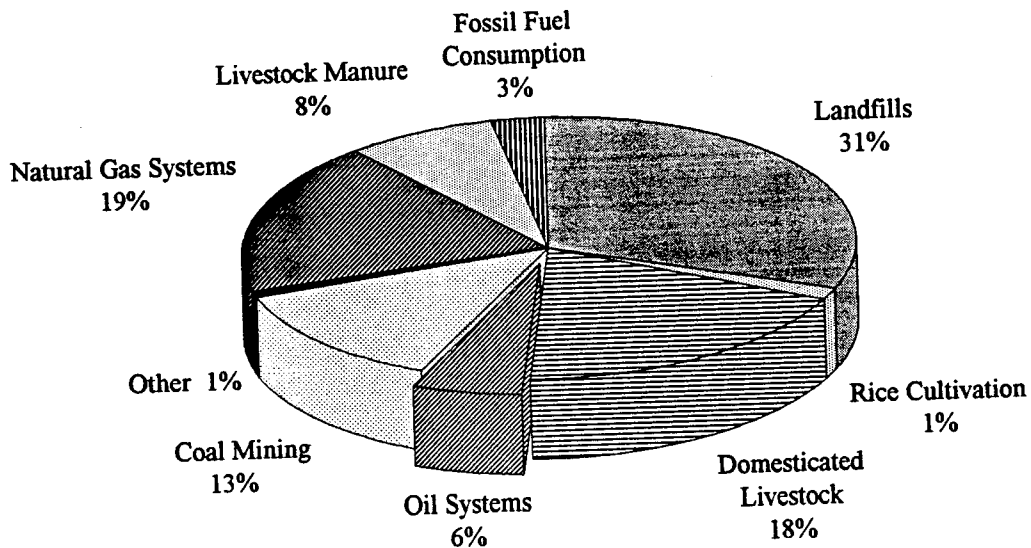

Figure 1-1. Sources of Methane Emissions (Including Results from This Study)

In general, previous emission studies for the petroleum industry underestimated total emissions since they did not include all emission sources. This Environmental Protection Agency (EPA) study strove to examine all likely methane emission sources and produce initial estimates for those sources. Statistical analysis of precision is also attempted based on available data. Additional field data gathering, field measurement programs, and data analysis in later phases will improve the estimate and reduce potential biases. Key assumptions and data issues are discussed in this report, and recommendations for future updates are provided.

## 2.0 INTRODUCTION

Greenhouse gases allow solar radiant energy to pass through the atmosphere to be absorbed by the Earth's surface, but, due to their radiative-forcing properties, trap in the lower atmosphere much of the radiant heat emitted from the surface back toward space. The portion of the energy that is absorbed by the greenhouse gases warms the Earth's surface, creating what is called the "natural greenhouse effect."<sup>1</sup> Naturally occurring greenhouse gases include water vapor, carbon dioxide (CO<sub>2</sub>), methane (CH<sub>4</sub>), nitrous oxide (N<sub>2</sub>O), and ozone (O<sub>3</sub>). The current scientific debate surrounding the greenhouse gas effect on global temperatures focuses on how sensitive the Earth's climate is to anthropogenic greenhouse gas emissions (those resulting from human activities).<sup>3</sup> On the basis of the belief that greenhouse gas emissions from anthropogenic activities are contributing to global climate changes, over 133 countries have signed an agreement under the 1987 Montreal Protocol to work towards limiting climate change and its effects.<sup>1</sup>

Energy related activities are the most significant source of U.S. anthropogenic greenhouse gas emissions, accounting for 88 percent of total U.S. emissions annually on a carbon equivalent basis.<sup>14</sup> Atmospheric methane is second only to carbon dioxide as an anthropogenic source of greenhouse gas emissions. However, a molecule of methane contributes more than a molecule of carbon dioxide because it is more effective at trapping heat. Sources of anthropogenic methane emissions include landfills, agricultural activities, fossil fuel combustion, coal mining, wastewater treatment, and the production and processing of natural gas and oil. Figure 2-1 shows a breakdown of the methane emissions according to a study of greenhouse gas emissions by the EPA and updated to reflect results from a Gas Research Institute (GRI) and EPA's Office of Research and Development (EPA-ORD) study on methane emissions from the natural gas industry.<sup>12</sup>

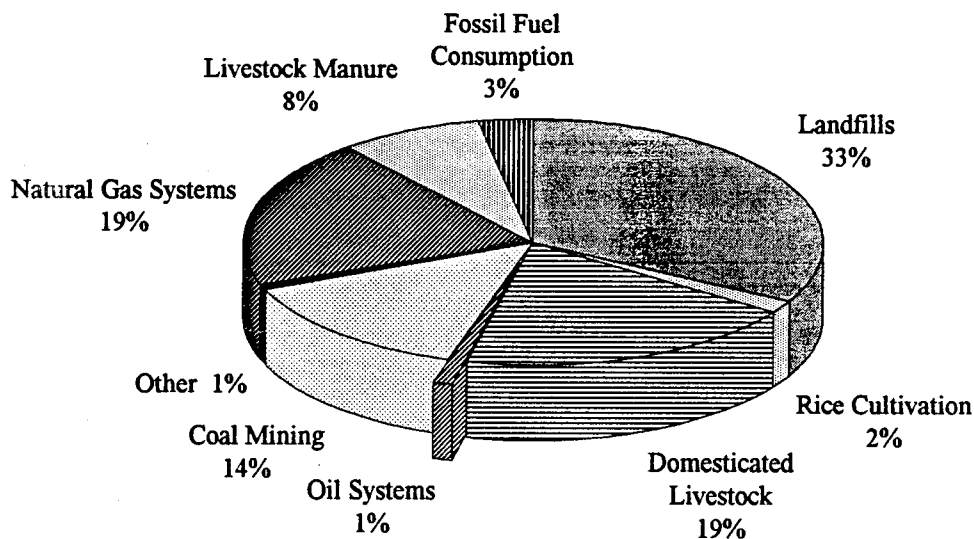

Figure 2-1. Sources of Methane Emissions (Previous Studies)

The purpose of this study was to begin the process of detailed quantification of methane emissions from the petroleum industry. This was accomplished by providing a level of magnitude estimate of emissions based on the sum of initial estimates for all likely equipment sources. Subsequent phases of this study, which have not yet been initiated, will further refine the estimate by gathering segment activity factors and directly measuring petroleum segment field data. When all phases are complete, the petroleum industry emission estimate will have a level of detail that will complement a similar 1996 study on methane emissions from the natural gas industry conducted by the GRI and EPA-ORD.<sup>2</sup>

This report presents initial estimates of the methane emissions that result from the field production, transportation, and refining sectors of the petroleum industry in the United States. Estimates for the years 1986 through 1993 are shown. This project identifies existing data and uses those data with extrapolation techniques to estimate U.S. petroleum industry methane emissions.

This project used data from several existing studies on methane emissions, including those from: 1) American Petroleum Institute (API);<sup>5,6</sup> 2) the EPA Office of Air and Radiation (OAR);<sup>4</sup> and 3) the GRI methane project for the natural gas industry.<sup>2</sup> The data from the GRI/EPA natural gas study, when combined with the data from final phases of this project, will form a detailed emission inventory for methane from the oil and gas industry as a whole.

The two EPA studies that previously presented petroleum industry methane emissions data are “Anthropogenic Methane Emissions in the United States—Estimates for 1990”<sup>4</sup> and “Inventory of U.S. Greenhouse Gas Emissions and Sinks: 1990-1994.”<sup>1</sup> Results of these reports are widely published and will be presented and analyzed further in Section 8.

## **2.1 PROJECT STRUCTURE**

This project began with an identification of previous studies on methane emissions from the petroleum industry. A detailed literature search was performed to identify all sources of information on methane emissions related to this subject. Once gathered, these studies were compared in order to determine industry boundary definitions, detail level, representativeness, comprehensiveness, and data quality. Section 2.2 briefly describes the results of the literature search and project ranking techniques. Appendix A provides extensive detail on the literature search.

Section 3 of this report is the industry emission characterization. Descriptions of three segments of the petroleum industry are presented: production, crude transportation, and refining. Three different emission types are also discussed: fugitive, vented, and combusted. This characterization allows a comprehensive structure for the emission estimate that identifies all potential sources.

Section 4 presents the statistical methods used for this study. Standard error propagation techniques were used to determine the overall accuracy and precision of the estimate.

Section 5 presents the methods selected to compute methane emissions from the petroleum industry and the results of the estimate. Section 5.1 summarizes the activity factors used for the 1993 base year and Section 5.2 presents the 1993 emission factors. The total methane emission estimate for 1993 is presented in Section 6.

Section 7 presents historical estimates for methane emissions. Estimates for the years 1986-1992 were made by modifying the activity factors from the 1993 base year. Emission factors were assumed to have remained unchanged over the 1986-1993 time period.

Conclusions from the emission estimates are discussed in Section 8. Section 9 presents potential future efforts for this type of study. Uncertainties in the 1993 estimate were analyzed to identify gaps or uncertainties in the data. These weaknesses could be strengthened in the future through more accurate measurement or research efforts. Section 10 presents a list of references cited in this report.

## 2.2 LITERATURE SEARCH

A comprehensive literature search was performed at the start of this project. The purpose of this search was to determine what type of information was available from previous studies conducted on the topic of methane emissions from the petroleum industry. A total of 54 reports were identified from the literature search and reviewed. Results of this search can be found in Appendix A.

The methodologies used by each previous study for the estimation of activity factors (equipment populations) and emission factors (average emission rate per equipment type) were evaluated according to a scale developed for this project. Each reference was subjectively ranked using generally accepted data quality guidelines to determine the detail level and applicability of emission factors and activity factors. Tables 2-1 and 2-2 show the ranking values used by this project.

TABLE 2-1. RANKING OF EMISSION FACTOR DATA QUALITY

EMISSION FACTOR DATA QUALITY	DETAIL LEVEL FOR EMISSION FACTORS		
	Equipment Level	Process Unit Level	Entire Industry Segment
Measurements	best	good	not applicable
Field data and calculations	very good	reasonable	not applicable
Miscellaneous data taken from other reports	unknown	unknown	unknown
Estimate	poor	poor	worst



**TABLE 2-2. RANKING OF ACTIVITY FACTOR DATA QUALITY**

ACTIVITY FACTOR DATA QUALITY	DETAIL LEVEL FOR ACTIVITY FACTORS		
	Equipment Counts <sup>a</sup>	Process Unit Activity Data <sup>b</sup>	Entire Industry Activity Factors <sup>c</sup>
Nationally tracked and reported, well known	best	good	not applicable
Extrapolated from samples/field data	very good	reasonable	not applicable
Miscellaneous data taken from other reports	unknown	unknown	unknown
Estimate	poor	poor	worst

<sup>a</sup>Equipment Counts (Counts of specific equipment and/or detailed activities)

<sup>b</sup>Process Unit Activity Data (based on unit counts and feed rates)

<sup>c</sup>Entire Industry AF (based on total oil produced or refined)

These tables, which were developed for this project, present a matrix scale of data quality for emission factors and activity factors, respectively. Data quality is a function of the detail level of the calculations and the basis for the emission factors. Emission factors can be determined from broad estimates, data-based estimates, or field emission measurements. The method used varied in each segment of the petroleum industry on the basis of available information and the nature of the segment itself. The tables show a matrix of data quality ranging from worst to best. The matrix is based on a scale of increasing level of detail. In these tables, "worst" indicates that the emission or activity factor estimate is from poor or incomplete background information. "Best" indicates that scientifically valid equipment-level measurements were performed for the emission factor, and that the equipment-level activity factor is based on a documented nationally tracked source. For both tables, "unknown" indicates that a ranking could not be estimated since no documentation was provided.

Of the 54 reports identified from the literature search, seven were used in the emissions estimate. The remaining reports were determined to be either potentially applicable to specific emission sources, but with much uncertainty, or were not applicable to this study. Of the 54 reports, none met all of the criteria established for data quality. One-third of the reports were based on data collected before 1985; none of the reports addressed all of the industry segments of interest or presented emission data for all sources of interest. On the basis of the results of the literature review, the project scope shifted from compiling existing emission inventories to focusing on developing an emission estimate.

### 3.0 INDUSTRY EMISSION CHARACTERIZATION

The first step in estimating methane emissions from the U.S. petroleum industry is to identify and characterize each emission source within the industry. This will ensure that all significant sources are included. To characterize the industry completely, sources were defined by industry segment and emission type.

The next step is to determine the method to estimate emissions. If emissions could be sampled from *every* source in the petroleum industry, then the total national emissions would be the sum of every source. Unfortunately, because of the size of the industry, measuring emissions from every source is impractical. Therefore, a method of extrapolating the sampled emissions from a representative set of sources within the industry is necessary. The activity factor (AF) extrapolation method was used for this purpose.

The AF extrapolation method is used to scale-up the average annual emissions from a source to represent the entire emissions from the national population of similar sources in the industry. The method uses emission factors (EFs) and AFs to do this. An EF for a source category is a measure of the average annual emissions per source (e.g., emission rate per equipment or per activity). The EF is a summation of all measured or calculated emissions from sampled sources divided by the total number of sources in the category that was sampled. AFs are estimated populations of equipment or estimated frequencies of activities. The national AF is the total number of sources in the entire target population or source category. An AF is usually presented as an equipment count, but a few exceptions exist, such as hp-hrs for compressors, petroleum production rates or throughputs, and events per year for maintenance activities. The EF and AF are defined so that their product equals the total annual nationwide emission estimate from a specific source in the petroleum industry. This relationship is shown in the equation below:

$$EF_i \times AF_i = AE_i \quad (1)$$

where:        I        =    source type, and  
              AE<sub>i</sub>    =    annual emissions from source type I.

#### 3.1 SEGMENT DESCRIPTIONS

The petroleum industry can be broken down into the following distinct segments for emission estimates: production, crude transportation, refining, product transportation, and end use. This study's scope is limited to the first three segments of the industry. Figure 3-1 represents a simplified conceptual diagram of the five industry segments.

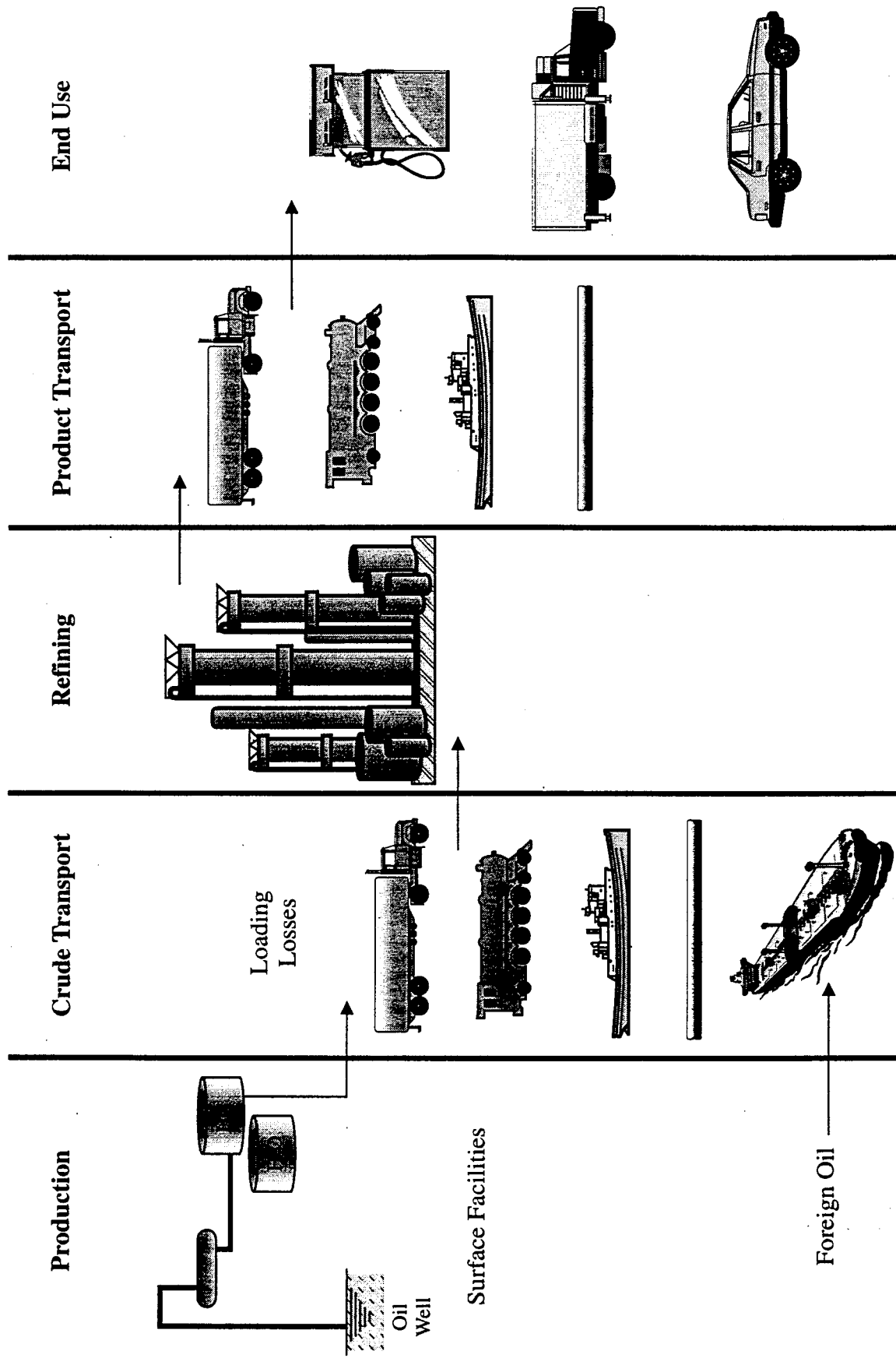

Figure 3-1. Petroleum Industry Segments

### **3.1.1 Production**

The production segment covers the exploration and extraction of petroleum from underground resources in the United States. It does not include foreign production of oil that is imported to the United States, but does include all U.S. well and surface production equipment and storage tanks. Because oil and gas can be produced from the same well, the production segment presents some interesting boundary issues. Some oil well equipment, such as compressors used to transport natural gas to sales, may be related solely to natural gas production and should not, for the purposes of this study, be part of the petroleum industry.

Figure 3-2 shows the petroleum sector boundary definitions as defined in the GRI/EPA project.<sup>7</sup> The GRI/EPA study of methane emissions from the natural gas industry is the only report that deals with the production boundary issue at the equipment level. The present EPA report elected to remain consistent with the boundaries selected in the earlier GRI/EPA project.

### **3.1.2 Crude Transportation**

The crude transportation segment covers all movement of crude from the production segment to refineries. Crude transportation includes all truck, marine, rail, and pipeline transportation of crude; loading and unloading of tank trucks, rail cars, and marine vessels; and all emissions associated with pipeline terminals and pump stations. It also includes the transportation of crude oil imported into the United States.

### **3.1.3 Refining**

The refining segment includes all refinery sites that take in crude and produce finished products such as gasoline. Refining volumes include imported crude oil. Refining includes crude storage, all refinery units, and finished product tanks. Aromatics and isomerization processes in refineries also are included. The refinery boundary, however, excludes the downstream chemical plant operations such as steam cracking ethylene plants, plastic/rubber operations, and speciality products (even though these operations may sometimes be integrated within a refinery complex). The refinery boundaries are consistent with those used by the *Oil and Gas Journal* for reporting refining activities.<sup>8</sup>

## **3.2 EMISSION TYPES**

Methane emissions from each piece of equipment in the petroleum industry can be classified as one of three general types: 1) fugitive; 2) vented; and 3) combusted. Emissions were analyzed for the facilities and equipment comprising each segment of the industry. Each source (i.e., piece of equipment) was then examined for different emissions during different operating modes. Emissions from each source were categorized as fugitive, vented, or combusted. Some pieces of equipment, such as compressors, may emit gas under all three

**Oil Wells**

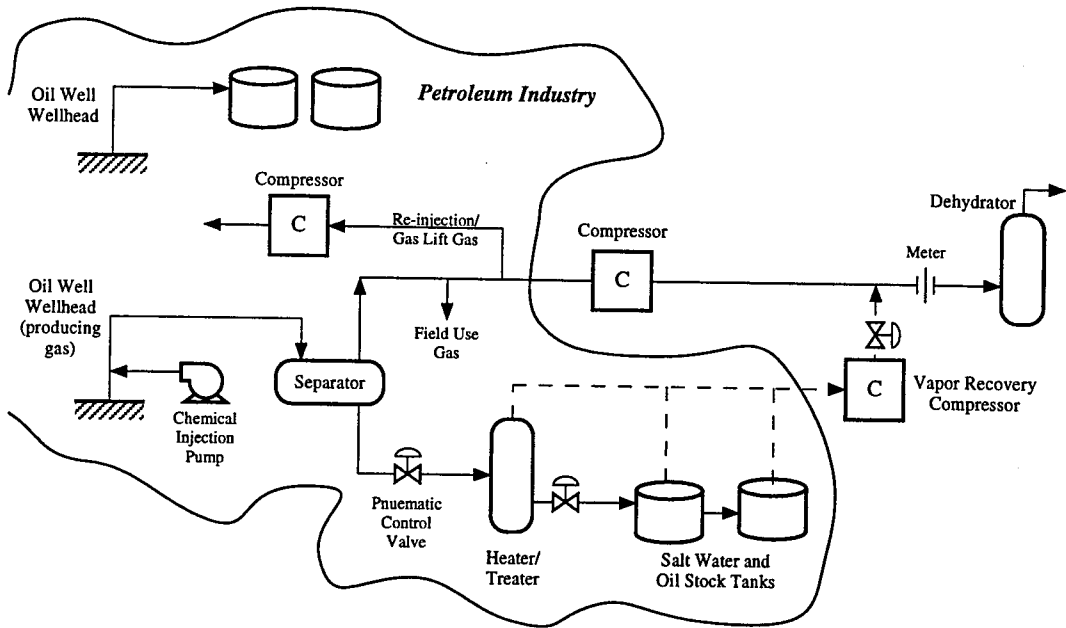

**Gas Wells**

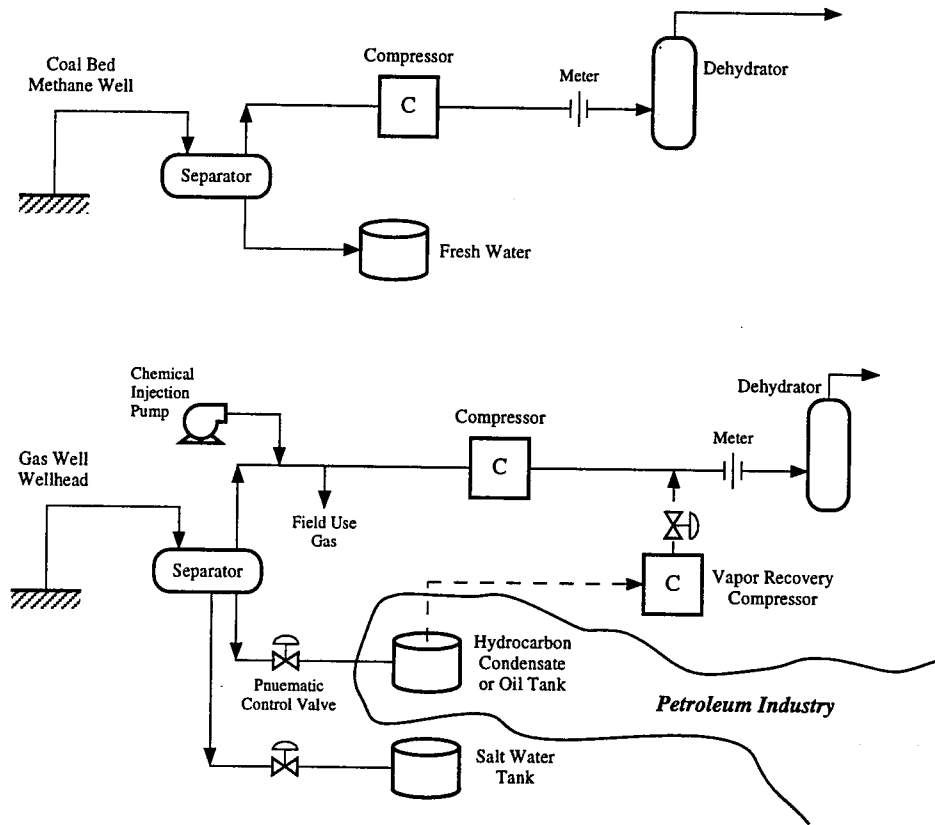

Figure 3-2. Industry Boundaries

categories (fugitive emissions when pressurized, vented emissions when blown down for maintenance and combustion emissions for the driver engines during normal operations). Definitions of the three types of emissions are presented below.

### **3.2.1 Fugitive**

Fugitive emissions are unintentional leaks emitted from sealed surfaces, such as packings and gaskets, or leaks from pipelines (resulting from corrosion, faulty connections, etc). Fugitive emissions or equipment leaks are typically low-level emissions of process fluid (gas or liquid) from the sealed surfaces associated with process equipment. Fugitive emissions do not include periodic vented emissions. Specific fugitive source types of emissions include various components such as valves, flanges, pump seals, or compressor seals. These components represent mechanical joints, seals, and rotating surfaces, which tend to wear and develop leaks over time.

### **3.2.2 Vented**

Vented emissions are releases to the atmosphere by design or operational practice. Examples of vented emissions include emissions from continuous process vents, such as dehydrator reboiler vents; maintenance practices, such as blowdowns; and small individual sources, such as gas-operated pneumatic device vents.

### **3.2.3 Combusted**

Combusted emissions are exhaust emissions of unburned methane fuel from combustion sources such as compressor engines, burners, and flares. Incomplete combustion of methane fuel in compressor engine exhaust is the only significant source of methane in this category.

## 4.0 STATISTICAL METHODS

A key part of this project is the accuracy estimation of the overall national methane emission rate. Accuracy is dependent on precision and bias. In general, precision refers to the random variability in the measurements. Measurements with low random variability have good precision and tight confidence bounds. Bias is a systematic error in the measurements. Bias must be discovered and eliminated, since it is often difficult, if not impossible, to calculate.

For most calculations, bias is assumed to be zero, and this assumption is checked through tests. If a test shows bias, additional samples are added or the sample set is stratified to eliminate the bias. Precision can be calculated more directly; namely, by propagating error from each individual group of measurements into the final numbers. This report used the same statistical methods for calculating precision and bias (to the extent possible) as described in depth in the GRI/EPA statistical methods report.<sup>9</sup>

Many EFs and AFs are made up of an average of multiple measurements or calculations. Therefore, assuming a normal distribution around a mean and error independence, standard deviations and 90% confidence intervals can be calculated directly for each group of EF or AF measurements. For this report, many EF and AF confidence bounds were set by engineering judgment, since no statistical data were available.

The confidence intervals or error bounds can be propagated through the multiplication of EFs and AFs, and through the addition of multiple emission categories to arrive at a confidence bound for the total national emission estimate. These generally accepted statistical techniques are briefly described in the following sections.

### 4.1 PRECISION

The following basic statistical calculations were performed for EFs. A different and more complex approach, described later in this section, was used for some AFs. Suppose there are  $n$  individual estimates of a given emission factor. If  $y_i$ , where  $i=1$  to  $n$ , are the individual data points, then the factor is estimated as the average,  $\bar{y}$ , of the  $n$  values:

$$\bar{y} = \frac{\sum_{i=1}^n y_i}{n} \quad (2)$$

The next step is to compute the uncertainty of this value. First,  $s_y$ , the standard deviation of the  $y$  values, is needed:

$$s_y = \frac{\sqrt{\sum_{i=1}^n (y_i - \bar{y})^2}}{n-1} \quad (3)$$

A 90% confidence interval is then calculated for the mean value,  $\bar{y}$ . The confidence interval establishes lower and upper tolerances for the estimate. There is only a 5% chance that the true value falls below the lower limit of this confidence interval. There is also a 5% chance that the true value falls above the upper limit of the interval. Thus, there is a combined 10% chance that the true value falls outside the confidence interval. Since there is a 90% probability that the true value falls within the interval, it is called a 90% confidence interval. The 90% confidence interval is computed as follows:

$$\bar{y} \pm t s_y / \sqrt{n} \quad (4)$$

The  $t$  value in this equation is obtained from a standard table for the  $t$  distribution; such tables are found in most basic statistics books.<sup>10</sup> The  $t$  value is a function of the confidence level (90% in this case) and the sample size,  $n$ .

Determination of national activity factors is often more complicated than determining emission factors, and the resulting calculation of the activity factor confidence bound is also more complicated. A database of emission factor measurements may simply be a set of replicate measurements, where the national emission factor is simply the average of the measurements and the confidence bound simply describes the scatter of the replicate measurements. A database for an activity factor (an equipment count) often requires extrapolation to obtain a national value. The confidence bound determination must take that extrapolation into account. The following paragraphs briefly describe the techniques used to calculate the confidence bound of an extrapolated activity factor.

If the activity factor estimate is assumed to be approximately normally distributed, then the 90% confidence limits for the activity factors can be estimated using Cochran's equation 6.14.<sup>10</sup> The equation for the 90% confidence interval (symmetric) for the activity factor is:

$$\pm t_{(1-\alpha/2, n-1)} \sqrt{v} \quad (5)$$

where:  $t_{(1-\alpha/2, n-1)}$  = the  $1-\alpha/2$  probability of the Student's  $t$  Distribution with  $n-1$  degrees of freedom.  
 $v$  = variance



The equation for the variance is:

$$v = \frac{N^2(1-f)}{n(n-1)} \sum_{i=1}^n (y_i - \hat{R}x_i)^2 \quad (6)$$

where:

- $y_i$  = the number of equipment at site I in the sample set;
- $x_i$  = the number of wells or amount of production at site I in the sample set;
- $n$  = number of sites sampled;
- $N$  = the total number of sites nationally;
- $f$  = sampling fraction =  $n/N$ ; and
- $\hat{R}$  = activity factor ratio =  $(AF/EP)_{\text{sample}}$ .

The total number of sites ( $N$ ) is not known nationally. Thus, it must be estimated by the following equation:

$$N = \frac{(\text{Production or Wells})_{\text{total, nationally}}}{\left[ \frac{(\text{Production or Wells})_{\text{total, sample}}}{n} \right]} \quad (7)$$

Either production rate or wells can be used in the equation, depending on which extrapolation parameter is used.

## 4.2 PROPAGATION OF ERROR

This section discusses the general techniques used to propagate the error bounds (for precision) that are calculated in Section 4.1. The error bounds of two numbers can be propagated to determine the error bound of their sum and/or their product. These techniques are covered in more detail in the GRI/EPA statistical methods report.<sup>9</sup> Multiplication is often used in this study since the basic extrapolation technique was to take the product of  $AF \times EF$  to obtain the source's emission rate (see Section 3.0). Addition is also used frequently since all of the individual source emission rates are summed to obtain the national annual emissions from the petroleum industry.

Section 4.1 discussed the calculation of 90% confidence half widths for a single term, such as an EF or AF. These confidence half widths can be substituted into the following equations (shown in Tables 4-1 through 4-3) to determine the confidence bounds for addition and multiplication/division.

For uncorrelated values (values not related to each other), the error bound (90% confidence half width) of a sum is the square root of the sum of the squares of the absolute errors of the values being summed, as illustrated in the following example. Suppose the following values, A and B, are to be summed, and the confidence bound of value "A" is expressed as  $\pm$  "a"

(in absolute terms). The bottom cell of Table 4-1 shows the resulting error calculation for the sum.

**TABLE 4-1. ERROR PROPAGATION FOR ADDITION**

VALUES TO BE SUMMED	90% CONFIDENCE HALF WIDTHS	
	Absolute Value	Relative Error (Percent Value)
A	a	a% = 100 × a/A
B	b	b% = 100 × b/B
Sum = (A + B)	absolute error of (A+B) = square root of (a <sup>2</sup> + b <sup>2</sup> )	

For correlated values, the equation for error becomes:

$$(a^2 + b^2 + 2rab)^{1/2} \tag{8}$$

where r is the correlation coefficient between A and B. However, r was assumed to be zero since most categories were derived from different data and were unrelated.

The error bound (90% confidence half width) associated with the product of two numbers is also calculated with the absolute errors of the terms being multiplied. Suppose that  $A \times B = C$ , and that the absolute errors for A and B are expressed as  $\pm$ “a” and  $\pm$ “b”, respectively. The errors expressed as a fractional value would be  $f_a$  and  $f_b$ , respectively. The bottom cell of Table 4-2 shows the resulting error calculation for the product.

**TABLE 4-2. ERROR PROPAGATION FOR MULTIPLICATION**

VALUES TO BE MULTIPLIED	90% CONFIDENCE HALF WIDTHS	
	Absolute Value	Relative Error (Fractional Value)
A	a	$f_a = a/A$
B	b	$f_b = b/B$
Product = (A × B)	relative error of product = square root of [ $f_a^2 + f_b^2 + (f_a^2 \times f_b^2)$ ]	

The error bound for division of two numbers ( $A \div B$ ) can be expressed in terms of the absolute errors (a and b). Table 4-3 shows the equation for division of two uncorrelated quantities.

TABLE 4-3. ERROR PROPAGATION FOR DIVISION

VALUES TO BE DIVIDED	90% CONFIDENCE HALF WIDTHS	
	Absolute Value	Relative Error (Fractional Value)
A	a	$f_a = a/A$
B	b	$f_b = b/B$
Division = (A ÷ B)	relative error of (A÷B) = square root of { [(A/B) <sup>2</sup> ] × [f <sub>a</sub> <sup>2</sup> + f <sub>b</sub> <sup>2</sup> ] }	

The following example illustrates the use of the statistics equations presented in this section. The example involves two numbers, A and B, where A is 10 with an absolute error of 5 and B is 6 with an absolute error of 2. This means that A is a number bounded by 5 and 15, and B is between 4 and 8. Table 4-4 shows A and B in terms of the variables presented in this section.

TABLE 4-4. VALUES FOR EXAMPLE CALCULATION

VALUES	90% CONFIDENCE HALF WIDTHS		
	Absolute Value	Relative Error (Percent Value)	Relative Error (Fractional Value)
A = 10	a = 5	a% = 50.0%	$f_a = 0.500$
B = 6	b = 2	b% = 33.3%	$f_b = 0.333$

Lastly, Table 4-5 shows the resulting errors when A and B are added, multiplied and divided.

TABLE 4-5. ERRORS FOR ADDITION, MULTIPLICATION, AND DIVISION OF EXAMPLE PROBLEM

OPERATION	90% CONFIDENCE HALF WIDTHS		
	Absolute Value	Relative Error (Percent Value)	Relative Error (Fractional Value)
A+B = 16	5.39	33.7%	0.337
A×B = 60	37.4	62.3%	0.623
A÷B = 1.67	1.68	100.3%	1.003

### 4.3 SCREENING FOR BIAS

It is impossible to prove that there is no bias in any data set. Although tests can be designed that are capable of revealing some bias, there are no tests or group of tests that will reveal all possible biases. Assuming that a data set has no bias, even after extensive testing, is only a hypothesis. Such hypotheses can be disproved but cannot be definitively proven. To the extent possible the data used for this project were checked to identify biases. The basic methods used to screen for bias included analysis of the data and extrapolation by different parameters (EPs).

The production site data were analyzed for bias by extrapolating the AFs with multiple parameters (the site data and extrapolation results are presented in Appendix B). For a subset of data that is perfectly representative of the crude production industry, equipment counts from the data set could be extrapolated to national totals by any variable in the data set. Any extrapolation from the perfect subset of data would result in the correct answer, regardless of the parameter used. For an imperfect data set, which all data sets are, extrapolation by multiple variables provides a cross check for bias. For example, in production, the equipment counts can be extrapolated by production rate or well count. These two methods produced different results that were averaged to minimize the potential bias from a single method.

Some significant potential biases are believed or known to exist in this report, owing to the limited nature of the data gathering (no new data or new measurement campaigns were performed as part of this project). Production site data based on data collected for the GRI/EPA natural gas study were available for the petroleum industry. A separate site data collection effort was not part of Phase 1, of this study. It is clear that the small data set has some very large differences and is not an ideal microcosm for the U.S. petroleum production segment. Significant problems with the production site database include the following:

- Sites do not represent a random sampling of oil production facilities in the United States;
- A complete set of equipment counts is not available for all of the sites; and
- Sites do not truly represent a random sampling of oil production facilities in the United States (but the sites had to be assumed to be similar to the average facilities);
- Some commonality between the operations and equipment in light oil and heavy oil service are assumed unless otherwise noted. It is known that these facilities may actually vary widely.

Bias checks of activity factors used in the production segment were necessary since most of the production activity factors were developed by this project. Bias checks in the production segment were simple to perform since the sample database could be compared against some known national values. Bias checks for activity factors in the other segments, crude transportation and refining, were not necessary since most of the activity factors were from published, well defined sources. These published factors, which were not on an equipment detail

level, did not depend upon sample (site visit equipment count) databases, so there was no need nor method for bias checks.

Some biases exist in the data set and they are believed to affect the overall estimate. The actions taken to minimize the effect of bias in the production data set are discussed in detail in Section 5.1.1. Some future work will be required to minimize bias. Minimization and/or elimination of potential biases are discussed as future efforts in Section 9.

## **5.0 ACTIVITY FACTORS AND EMISSION FACTORS—1993 BASE YEAR**

Sections 5.1 and 5.2 present the sources and units used for the AFs and EFs, respectively. Each section is further divided into the three industry segments studied (production, crude transportation, and refining).

### **5.1 ACTIVITY FACTORS - 1993 BASE YEAR**

Two general methods were used to estimate AFs for the 1993 base year. First, national AFs were taken from existing sources, such as the *Oil and Gas Journal*,<sup>8,11</sup> *World Oil*,<sup>12</sup> the GRI/EPA natural gas study,<sup>4</sup> American Petroleum Institute (API) Report 4615,<sup>13</sup> the Pipeline Systems Inc. (PSI) study,<sup>14</sup> and other published sources. Second, some production segment AFs were extrapolated from oil field site visits performed during the GRI/EPA natural gas study. For some categories, data from published sources had to be modified for use with this study; these modifications are discussed below. Data taken directly from sources are referenced. Table 5-1 summarizes the AFs used for this report.

#### **5.1.1 Production Rate and Well Count**

The two most important AFs in the production segment are total crude oil production rate and well count. Annual production for the 1993 base year is 6,846,000 barrels of crude per day, which is taken from a 1995 *Oil and Gas Journal* article.<sup>15</sup> Total number of producing oil wells for 1993 is 583,879 which is taken from *World Oil*.<sup>12</sup> These values are used to generate other AFs for the production segment. The confidence intervals for these sources are based on engineering judgment. Since these are well-documented values, based on credible data that are nationally published, a confidence interval of  $\pm 5\%$  was assigned.

To correspond to the EF split between heavy and light crude, production rate and well equipment counts were divided into heavy and light crude. The API Report 4615<sup>13</sup> designated heavy crude as having an API gravity of less than 20° and light crude as having an API gravity of greater than 20° for the purposes of establishing EFs. A 1984 report by the Interstate Oil Compact Commission was used to determine the volume of heavy crude produced for all states with heavy crude production except Alaska.<sup>16</sup> Alaska's Natural Resources Department was contacted separately for this information. For the years in which heavy crude production was reported (1976 through 1981, with the exception of Alaska, which is based on 1993 data), the total crude production for the same year was determined for each state by referencing the *Oil and Gas Journal*.<sup>15</sup> A ratio of heavy crude production to total crude production was calculated, as shown in Table 5-2.

TABLE 5-1. 1993 ACTIVITY FACTORS BY SEGMENT

PRODUCTION		
Published (Well Known)	Developed	
<i>Source Category</i>	<i>Activity Factor</i>	<i>Source Category</i> <i>Activity Factor</i>
Crude oil production rate	6,846,000 bbl/day	Heavy/light crude ratio      10.7%/89.3%
Well count	583,879 wells	Heavy/light well ratio      7.1%/92.9%
Crude oil completions	390 completions	Oil wellheads      41,163 heavy, 542,716 light
Exploratory wells drilled	390 wells	Separators      9,103 heavy, 113,071 light
Well workovers	43,791 workovers/year	Heater-treaters      77,354 heater treaters
Burners	3,647,000 bbl/year	Compressors (in light crude service)      647 small, 1,940 large
Well blowouts	2.85 blowouts/year	Gas lift compressors      2,799 compressors
		Pneumatic devices      117,008 devices
		Chemical injection pumps (CIPs)      125,088 CIPs
		Headers      15,296 heavy, 47,291 light
		Tanks      54,272 tanks in light service
		Fields (for sales areas)      4,443 fields
		Offshore platforms      1,092 Gulf, 22 rest of U.S.
		Pipeline miles      70,000 miles
		Gas engines      17,634 MMhp-hr
		Pressure relief valves      422,936 PRVs

(Continued)

TABLE 5-1. 1993 ACTIVITY FACTORS BY SEGMENT  
(Continued)

CRUDE TRANSPORTATION		
<i>Source Category</i>	<i>Activity Factor</i>	<i>Source Category</i>
Published (Well Known)		Developed
Crude pipeline miles	55,268 miles	Pump stations
Volume transported by truck	7.69E+07 bbl/year	Volume stored in tanks (total transported)
Volume transported by marine	9.54E+10 gal/year (2.27E + 10 bbl/year)	553 stations
Volume transported by rail car	8.91E+06 bbl/year	9.07E+09 bbl/yr
Volume transported by pipeline	6.71E+09 bbl/year	

(Continued)



TABLE 5-1. 1993 ACTIVITY FACTORS BY SEGMENT  
(Continued)

Published (Well Known)		Developed	
<i>Source Category</i>	<i>Activity Factor</i>	<i>Source Category</i>	<i>Activity Factor</i>
Total refinery charge of crude	13,612,259 bbl/day	Heaters	3,200 heaters
Charge rate to:		Engines	20,334 MMhp-hr
Vacuum distillation	5,935,032 bbl/day		
Thermal operations	1,661,140 bbl/day		
Catalytic cracking	4,694,106 bbl/day		
Catalytic reforming	3,287,291 bbl/day		
Catalytic hydrocracking	1,112,414 bbl/day		
Catalytic hydro refining	1,595,163 bbl/day		
Catalytic hydro treating	7,326,166 bbl/day		
Alkylation & polymerization	1,003,670 bbl/day		
Aromatics/isomerization	693,791 bbl/day		
Lube processing	177,624 bbl/day		
Asphalt production	631,440 bbl/day		

TABLE 5-2. RATIO OF HEAVY CRUDE PRODUCTION TO  
TOTAL CRUDE PRODUCTION

State	Year	Heavy Crude Production <sup>16</sup> (1000 bbl)	Total Crude Production <sup>15</sup> (1000 bbl)	Ratio of Heavy/Total Production	1993 Total Crude Production <sup>15</sup> (1000 bbl)	Estimated 1993 Heavy Crude Production (1000 bbl)
Alabama	1981	521	20,680	0.025	18,677	471
Alaska	1993	1,060	577,913	0.002	577,430	1,059
Arkansas	1976	4,682	17,885	0.262	10,599	2,775
California	1981	277,825	384,958	0.722	293,112	211,540
Colorado	1981	197	30,303	0.007	31,211	203
Illinois	1981	78	24,090	0.003	17,726	57
Kansas	1981	1,247	65,810	0.019	49,691	942
Louisiana	1979	16,769	494,575	0.034	407,340	13,811
Michigan	1980	10	33,580	0.000	13,799	4
Mississippi	1981	7,831	34,204	0.229	22,570	5,167
Montana	1981	341	30,813	0.011	17,431	193
New Mexico	1976	230	91,615	0.003	69,520	175
Oklahoma	1976	3,394	190,965	0.018	96,791	1,720
Texas	1981	20,079	945,132	0.021	620,210	13,176
Utah	1976	1,177	33,945	0.035	21,819	757
Wyoming	1981	24,275	130,563	0.186	87,667	16,300
Total for States with Heavy Crude Production					2,355,593	268,350
U.S. Total Crude Production, <sup>15</sup> 1000 bbl					2,498,425	
National Ratio of Heavy Crude to Total Crude						10.7%

The ratio of heavy crude to total crude production shown for each state in Table 5-2 was assumed to apply to 1993 production and well counts for the respective states. To estimate the national heavy crude production for 1993, the ratio of heavy crude to total crude was applied to the 1993 production rate of each state. The estimated 1993 heavy crude production for each state was then summed to generate a national heavy crude production of approximately 268 million barrels, which corresponds to 10.7% of the total crude production for 1993. The confidence bound ( $\pm 100\%$ ) associated with this estimate was assigned based on engineering judgment. The error bounds are wide, since 1976-1981 data were used to establish the heavy crude to total crude ratio for 1993.

The same procedure was used to estimate the number of wells in the United States that produce heavy crude, as shown in Table 5-3. The ratio of heavy crude production to total crude production for each state was applied to the number of crude wells in that state,<sup>12</sup> resulting in an estimate of the number of wells that produce heavy crude for that state. The state heavy crude

TABLE 5-3. RATIO OF HEAVY CRUDE PRODUCTION WELLS  
TO TOTAL CRUDE PRODUCTION WELLS

State	Year	Heavy Crude Production <sup>16</sup> (1000 bbl)	Total Crude Production <sup>15</sup> (1000 bbl)	Ratio of Heavy/Total Production	1993 Total Crude Production Wells <sup>12</sup>	Estimated 1993 Heavy Crude Production Wells
Alabama	1981	521	20,680	0.025	886	22
Alaska	1993	1,060	577,913	0.002	1,624	3
Arkansas	1976	4,682	17,885	0.262	8,466	2,216
California	1981	277,825	384,958	0.722	40,231	29,035
Colorado	1981	197	30,303	0.007	7,221	47
Illinois	1981	78	24,090	0.003	31,783	103
Kansas	1981	1,247	65,810	0.019	44,000	834
Louisiana	1979	16,769	494,575	0.034	22,264	755
Michigan	1980	10	33,580	0.000	4,201	1
Mississippi	1981	7,831	34,204	0.229	1,631	373
Montana	1981	341	30,813	0.011	3,600	40
New Mexico	1976	230	91,615	0.003	18,028	45
Oklahoma	1976	3,394	190,965	0.018	93,192	1,656
Texas	1981	20,079	945,132	0.021	181,501	3,856
Utah	1976	1,177	33,945	0.035	1,990	69
Wyoming	1981	24,275	130,563	0.186	11,287	2,099
Total for States with Heavy Crude Production					471,905	41,154
U.S. Total Crude Production Wells <sup>12</sup>					583,879	
National Ratio of Heavy Crude Wells to Total Crude Wells						7.05%

well counts were summed to give a national number of wells that produce heavy crude, which was divided by the total number of U.S. crude production wells, resulting in an estimated 7.05% of the total crude wells in the United States that produced heavy crude during 1993. A confidence bound of 100% was associated with this estimate based on engineering judgment.

### 5.1.2 Production Equipment Extrapolations from Site Visits

Equipment populations (separators, heater treaters, etc.) in the petroleum production segment are not tracked nationally. Thus, equipment extrapolations from site data must be carried out to estimate the national population. The equipment extrapolations in the production segment for this study were based on site visit data taken during the GRI/EPA natural gas study. The sites from the GRI/EPA study that were used in this project were sites in which oil was produced. There were 26 such sites, as shown in Table B-1 of Appendix B.

Production equipment extrapolations for this study were carried out for separators, heater treaters, pneumatic devices, chemical injection pumps (CIPs), and gas lift compressors. The

activity factor for blowdown emissions from vessels was estimated by assuming that the number of vessels was the sum of separators and heater-treaters.

The equipment extrapolations and statistical methods were carried out in the same manner as described in the GRI/EPA study. To briefly summarize, an AF ratio was determined for each equipment type by dividing the site AF, the total number of equipment in the sample data set, by the site extrapolation parameter (EP), which was the total number of oil wells (well basis) or oil production (throughput basis) in the whole sample data set. This sample AF ratio can be designated  $(AF/EP)_{\text{sample}}$ . Next, the AF ratio was multiplied by the extrapolation parameter  $(EP)_{\text{region}}$ , which was either the known U.S. oil production or number of wells. This product yields the extrapolated number of equipment for the well and throughput basis. This is illustrated in the following formula:

$$\left( \frac{AF}{EP} \right)_{\text{sample}} \times EP_{\text{region}} = AF_{\text{region}} \quad (9)$$

where:

$$\left( \frac{AF}{EP} \right)_{\text{sample}} = \frac{\sum_{i=1}^n AF_i}{\sum_{i=1}^n EP_i} \quad (10)$$

$n$  = number of individual sample sites in the data set

Table 5-4 shows the results of the extrapolations. Tables B-1 and B-2 in Appendix B show the detailed site visit data used to generate Table 5-4, and Table C-1 (in Appendix C) shows the corresponding statistical analysis. The following table (Table 5-4) shows that the results of the well extrapolation basis are very different than the results of the throughput extrapolation basis. This raises several questions: 1) are the sites representative of the petroleum industry; 2) is the equipment strictly related to one parameter, so that the extrapolation by the other parameter produces an erroneous result?; and/or 3) is there bias in the data set that resulted in the difference? These questions are examined in the following text.

Although the equipment extrapolations are based on data from 26 oil producing sites, these site visits were conducted as part of the GRI/EPA natural gas industry study.<sup>7</sup> The site data do not truly represent a random sampling of oil production sites, and may therefore introduce bias and account for some of the difference between the two extrapolation techniques. No new sites were visited as part of this Phase 1 study.

TABLE 5-4 EXTRAPOLATED ACTIVITY FACTOR DEVELOPMENT

<i>Equipment</i>	<i>Extrapolated Count</i>			
	<i>Well Basis</i>		<i>Throughput Basis</i>	
	<i>Count</i>	<i>Confidence Interval</i>	<i>Count</i>	<i>Confidence Interval</i>
Separators	217,804	50.9%	26,562	26.5%
Heater Treaters	143,491	150.5%	23,873	116.2%
Pneumatics	207,217	71.2%	26,800	72.6%
Chemical Injection Pumps	125,088	105.0%	24,959	92.2%
Gas Lift Compressors	12,523	94.1%	2,162	87.3%

Selection between the two EPs (wells or throughput) can be done on a technical basis if there is a clear technical relation between the particular type of equipment and one EP. This is the case for CIPs, where the pumps are predominantly located at the wellhead. Production segment technical advisors from the GRI/EPA natural gas study recommended that CIPs be extrapolated only by well count. For this study, the same recommendation was applied to CIPs in the oil industry. Logically, methane-powered CIPs could only be used on wells that have pressured gas available. That operational requirement would exclude many stripper wells. The sites visited, however, had a higher production per well than the U.S. known production rate per well. While some of the stripper wells visited for the dataset did have gas powered CIPs, it is very possible that the CIP extrapolation based on the 16 site visit wells does result in a high CIP count and methane emission bias in this category.

For other equipment, such as separators, heater treaters, pneumatic devices, and compressors, a clear technical basis for using one EP over the other could not be determined. There are cases where equipment count is related only to well count (such as individual, remote well sites, where equipment must be added for each new well), and cases where equipment count is related primarily to production rate (such as centralized facilities, where multiple wells are fed into one separator). The national population of these types of equipment, therefore, is related to both wells and production rates.

For similar circumstances in the natural gas production segment, technical advisors recommended combining the two extrapolation techniques by averaging the equipment counts that result from each method. The same approach is used for the oil production equipment associated with this study. However, the results from the two EP methods are farther apart for the petroleum industry than for the gas industry. Table 5-5 shows the selection basis used; the resulting extrapolation value for each source is highlighted.

**TABLE 5-5. PRODUCTION EXTRAPOLATION PARAMETER SELECTION**

Activity Factor	Extrapolation Parameter(s) Selected	Basis
Heater-Treaters	Mean of: 1) Oil wells and 2) Production rate  <b>(83,682 ± 78.0%)</b>	Heater-treaters can be related to both production rate and well count. Heater-treaters can be located at individual wells or central facilities, where production rate may play a factor. In the offshore area, the relation is stronger to production rate.
Separators	Mean of: 1) Oil wells and 2) Production rate  <b>(122,183 ± 78.0%)</b>	Separators can be related to both production rate and well count. Separators can be located at individual wells or central facilities, where production rate may play a factor. In the offshore area, separators are more strongly related to production rate.
Gas-Lift Compressors	Mean of: 1) Oil wells and 2) Production rate  <b>(7,342 ± 81.2%)</b>	Gas-lift compressors exist within the oil industry to artificially lift oil. The compressors can be located at each well site or at a central facility, where the number of compressors is related to production rate.
Pneumatic Devices	Mean of: 1) Oil wells and 2) Production rate  <b>(117,008 ± 78.0%)</b>	Pneumatic devices exist on oil well separators, heater treaters, gas-lift compressors, and some other equipment. Therefore, pneumatics are related to the equipment counts (which, as shown above, are related to both well count and production rate).
Chemical Injection Pumps (CIPs)	Oil wells only.  <b>(125,088 ± 105%)</b>	CIPs were found primarily at individual well sites, even where central separation facilities existed. CIPs therefore have a strong relation to well count. CIPs on gas wells were not counted in this study.

Table 5-5 also shows the arithmetic mean extrapolated equipment counts for each piece of equipment. The error bounds were determined using the statistical methods outlined in Section 4.1, except for the following cases. By using engineering judgment, the error bound for the separators and pneumatic devices were assigned 78%, since the calculated bound did not encompass the individual throughput and well extrapolations. This ensures that the error bound includes the counts given by the well and throughput extrapolations.

In addition to the technical reason for selecting the mean of both methods, a potential bias that exists in the data set can be corrected by selecting the mean. The well and throughput extrapolations produce different equipment counts, as Table 5-4 points out. Since it is known that the site database is less than ideal, bias checks were performed to see how well the collected data compare with the total U.S. oil production segment. Table 5-6 shows the comparisons made.

TABLE 5-6. COMPARISON OF SAMPLE SET TO NATIONAL VALUES

Sample Category	Site Visit Database	U.S. Known <sup>a</sup>	Corrections Made
Production per Well (bbl/d/well)	70.6	11.7	Selected the average of the well count and production extrapolations (except for chemical injection pumps)
% of Sites with Gas-Lift Compressors	23.8%	9.1%	Applied correction factor of 0.381 (9.1/23.8) to gas-lift compressor count
% of Oil Wells Offshore	6.4%	1.2%	No action taken

<sup>a</sup> Sources for U.S. data:

Number of Wells: *World Oil*, February 1994<sup>12</sup>

% of Sites with Gas Lift Compressors: JPT, 1993<sup>17</sup>

% of Oil Wells Offshore: GRI/EPA Activity Factor Report, 1992 Data<sup>7</sup>

Production/Well: Production from *Oil and Gas Journal*, January 30, 1995<sup>15</sup>

On the basis of these comparisons, the following biases were identified:

- 1) The site database results in a much higher production rate per well than the national average;
- 2) While the site database contains some stripper wells, it may not accurately represent the large population of stripper wells in the U.S.;
- 3) A larger number of gas lift sites are represented in the database than the national number; and
- 4) The limited site visit data have more offshore oil wells than the national number.

An attempt was made to analyze the effect of these biases in light of averaging the equipment counts that result from the two extrapolation techniques. The high production rate per well would be expected to produce a production rate extrapolation of AFs that was too low, and a well count extrapolation that was too high, so long as the equipment count was related to both EPs. The true value will lie between the two estimates. Appendix D demonstrates this point through some hypothetical examples.

For this project's production site data set, the well count extrapolation was much higher than the production rate extrapolation in every case, which tends to support the hypothesis that the equipment is related to both EPs. Unfortunately, it is not possible to determine the exact relation between equipment type and the EPs. Since it is not known how strongly the equipment is related to either wells or throughput, the arithmetic mean was used for all equipment except for CIPs. This same approach was used in the GRI/EPA natural gas study. As explained in Table 5-5, CIPs were assumed to be related only to wells, since the pumps are primarily located at the well head.

To correct for the high percentage of gas-lift sites in the database, a correction factor was applied to the extrapolated count of gas-lift compressors. A factor of 0.381 was developed on the basis of dividing the percentage of U.S. known gas-lift sites by the percentage in the site database

(0.381 = 9.1/23.8). Thus, this bias correction factor effectively adjusts the count of gas-lift compressors to be more consistent with the true number in the United States. Adding this correction factor lowers the count of gas-lift compressors from 7,342 to 2,799. The final corrected values are shown in Table 5-7.

**TABLE 5-7. FINAL PRODUCTION DEVELOPED ACTIVITY FACTORS**

Separators	122,183 <sup>a</sup> ± 78% <sup>c</sup>
Heater-treaters	83,682 <sup>a</sup> ± 130%
Pneumatic Devices	117,008 <sup>a</sup> ± 78% <sup>c</sup>
Chemical Injection Pumps	125,088 <sup>b</sup> ± 105%
Gas Lift Compressors	2,799 <sup>a,d</sup> ± 81%

<sup>a</sup> Arithmetic mean of well and throughput extrapolation method.

<sup>b</sup> Well method only.

<sup>c</sup> Used engineering judgement to assign confidence bound.

<sup>d</sup> Lowered from original extrapolation by a factor of 0.381 to account for site visit bias.

### 5.1.3 Miscellaneous Production Activity Factors

With respect to the count of gas-lift compressors (2,799 total), an assumption was made on the basis of site data and engineering judgment that 75% of the total compressors are large and 25% are small, with a confidence interval of 33%. This distinction was necessary since the fugitive EF varies for small and large compressors. Large compressors are those housed in facilities where the compressors will have a remote blowdown vent stack. They are similar to gas transmission compressors, which are located in station facilities. Small compressors are defined as those with a blowdown vent line located proximate to the compressor. No attempt was made to relate large and small compressors to horsepower. The distinction here is only related to the compressor vent arrangement, where the remote blowdown vent lines were found to have very large fugitive emission rates.<sup>13</sup>

In the production segment, most oil wells have some type of artificial-lift method in place. Approximately 85% of artificial lift wells use sucker-rod pumps. Gas lift, mostly continuous flow, make up about 10% of artificial lift wells. Electric submersible pumps (ESPs) are used on 4% of the wells. All other lift methods (hydraulic, reciprocating pumps, progressing cavity pumps, and plunger lifts) represent less than 5% total usage. Eighty percent of total artificial lift wells are classified as stripper wells that produce small volumes of oil. When the stripper wells are excluded, of the remaining U.S. oil wells (approximately 100,000 wells) 53% are gas lifted.<sup>17</sup> The majority of these are on continuous gas lift. This information is important to note because methane emissions are high from gas-lifted wells and compressors.

The AF for gas engines was derived from the count of compressors combined with an estimated horsepower per compressor as given in the AF report of the GRI/EPA natural gas study.<sup>7</sup> The GRI/EPA study reported 25,780 ± 134% MMhp-hr for all compressor engine drivers



in the natural gas processing segment. The study also reported that there are  $4,092 \pm 47.7\%$  reciprocating engines at gas plants. Thus, division of the total engine energy consumption by the number of engines yields 6.30 MMhp-hr/compressor ( $\pm 205.7\%$ ) in the natural gas processing segment. Engines in the natural gas processing segment were assumed to be similar to those of gas lift compressors in the petroleum industry. Therefore, the AF for combustion from gas-lift engines in annual MMhp-hr was determined by multiplying 6.30 MMhp-hr/compressor by the number of gas lift compressor determined from the equipment extrapolation in this study (discussed earlier in this section), resulting in 17,634 MM hp-hr for 1993. The confidence intervals for the division and multiplication used in this estimation method were calculated as described in Section 4.2.

Several other equipment counts were established for the purposes of estimating fugitive emissions. Total headers (15,296 heavy, 47,291 light) were taken from the API Report 4615 with the assumption of 0.37 headers/heavy well and 0.087 headers/light well.<sup>13</sup> These ratios are based on the equipment counts taken from the API report. The tank AF (54,272 light crude tanks) was also from the API report, which produced a net ratio of 0.1 tanks/light well. Once again, "heavy" equipment refers to equipment that is in heavy crude service (API gravity of less than 20°) and light equipment refers to equipment that is in service to light crude (API gravity, of greater than 20°).

The number of fields used to estimate sales areas (2,962) was taken from a report by ICF Resources Incorporated.<sup>18</sup> The error bound for the number of fields was assumed to be 30% based on engineering judgement. There is also an assumption of 1.5 areas per field based on engineering judgment, with an associated error of 33%. Thus, the total number of sales areas is  $4,443 \pm 46\%$ .

The number of offshore platforms for the Gulf of Mexico and the rest of the United States comes directly from the GRI/EPA natural gas study. There were 1,092 in the Gulf of Mexico and 22 in the rest of the United States. The GRI/EPA study presented the total number of platforms and the number of natural gas platforms; the difference yields the crude platforms. The total number of oil wellheads was taken directly from *World Oil*, where the split between heavy (41,163) and light (542,716) crude production was based on the ratio of heavy crude production to total crude production, as discussed previously (Section 5.1.1).<sup>12</sup>

The number of pipeline miles was taken from the GRI/EPA natural gas study.<sup>7</sup> This study reported 140,000 total pipeline miles with an assumed 50/50 split between petroleum and natural gas pipelines. Using the same assumptions, 70,000 ( $\pm 50\%$ ) production gathering miles are associated with the oil industry.

The number of crude well completions (390) was taken from the Energy Information Administration (EIA) "Annual Energy Review."<sup>19</sup> This number is also used as the AF for drilling as a combustion emission source (exploratory wells drilled). A confidence interval of 10% was assigned by engineering judgment based on the quality of the reported value.

An estimate of the number of well workovers per year (43,791) is taken from a PSI report, which estimated 7.5% of wells are worked over each year based on observations from two crude production sites.<sup>14</sup> Because of the limited sample size, a confidence interval of 100% was assigned to this AF.

The AF corresponding to burners (3,647,000 bbl/year) is based on the volume of crude oil consumed by pipelines and on leases as pump fuel, boiler fuel, and so forth. This number is reported by production companies on EIA Form 813 and published nationally in the *Petroleum Supply Annual*.<sup>20</sup> The confidence interval for this value was assigned by engineering judgment. Natural gas is also consumed as plant and lease fuel in crude production. The GRI/EPA natural gas study considered the total amount of natural gas reported as plant and lease fuel use to be part of the natural gas industry, where the portion of gas used to run compressors was subtracted from the total plant and lease gas use, and the remaining amount was assumed to be used in burners. Methane emissions from burners were negligible for the natural gas industry study, and are also believed to be negligible for the oil industry. Therefore, it was not necessary to determine the amount that might be attributed to the oil industry for this study.

The number of pressure relief valves (422,936 PRVs) was developed using the same methodology as the GRI/EPA natural gas study.<sup>7</sup> The GRI/EPA study estimated the number of PRVs associated with specific equipment types. For similar equipment used in crude production, the same ratios were used: 2 PRVs per separator ( $\pm 68\%$ ); 2 PRVs per heater treater ( $\pm 89\%$ ), assuming a heater treater is most similar to a separator; and 4 PRVs per gas lift compressor ( $\pm 84\%$ ). These ratios were then multiplied by the extrapolated equipment counts (Table 5-7) and summed to give the total number of PRVs. The confidence interval was calculated (using the methods described in Section 4.2) on the basis of the confidence intervals associated with the PRV to equipment ratios and the individual equipment counts.

The number of well blowouts annually (2.85) was estimated on the basis of a total of 57 well blowouts tracked by the U. S. Geological Survey for the years 1956 through 1977.<sup>21</sup> A large confidence bound of 200% was assigned to this estimate because of the age of the data.

#### **5.1.4 Crude Transportation**

The AF for pump station emissions is given in units of miles of crude pipelines (55,268 miles.) The *Oil and Gas Journal* reports total miles of crude trunk lines for interstate pipelines.<sup>11</sup> A national source for intrastate crude pipeline miles was not found. Therefore, the number of miles is underestimated. The AF corresponding to pipeline fugitive emissions ( $6.71\text{E}+09$  bbl/year) is the volume of crude transported by pipelines. The value reported by *Oil and Gas Journal* for crude trunk lines was used for this source. This AF is also underestimated because intrastate pipeline volumes are not included. The confidence interval for these sources was assigned 100% based on engineering judgment.

The EIA *Petroleum Supply Annual* reports volumes of crude delivered to refineries by mode of transport [tanker (2.11E+09 bbl/year), trucks (7.69E+07 bbl/year), barge (1.67E+06 bbl/yr), and rail cars (8.91E+06 bbl/year)] for both domestic and imported crude.<sup>22</sup>

The AF for tanks (9.07E+09 bbl/year) was estimated by assuming each barrel of crude transported is stored in a tank once. The total number of barrels transported to refineries was calculated by summing the volumes reported for each mode of transport (i.e., the sum of the volumes transported by pipeline, marine, rail, and truck). Note that the volume of crude transported by marine vessels (tankers and barges) is reported in gallons rather than barrels to correspond to the EF units. The confidence intervals were assigned by engineering judgment for the individual transport modes.

The AF for pump stations (553 stations) is based on the assumption that one gas operated pump station exists for every 100 miles of pipeline,<sup>14</sup> where the number of pipeline miles is taken from the *Oil and Gas Journal*, as discussed above.<sup>11</sup> Here also, the AF may be underestimated, since the *Oil and Gas Journal* excludes intrastate pipeline mileage. The confidence interval was assigned to be 100% by engineering judgment.

### 5.1.5 Refining

All of the AFs for refining emissions, except heaters and engines, are in units of barrels per day. Two sources of data, both from the *Oil and Gas Journal*, were used to generate the crude volumes for each refinery operation.<sup>8,23</sup> The *Oil and Gas Journal* reports crude feed rates in barrels per calendar day to each refinery process.<sup>8</sup> Calendar day throughputs for the individual refinery process units, which represent the maximum capacity of the unit, were adjusted to actual refinery still runs based on the total refinery utilization,<sup>23</sup> where the total utilization (total refinery capacity divided by crude runs to stills) was assumed to be applicable to each of the process units. The resulting throughputs (shown in Table 5-8) represent the actual volume of crude refined in each process per day.

TABLE 5-8. REFINERY THROUGHPUTS

Process	1,000 bbl/d
Vacuum distillation	5,935
Thermal operations	1,661
Catalytic cracking	4,694
Catalytic reforming	3,287
Catalytic hydrocracking	1,112
Catalytic hydrorefining	1,595
Catalytic hydrotreating	7,326
Alkylation/polymerization	1,004
Aromatics/isomerization	694
Lube processing	178
Asphalt production	631

The total volume of crude refined (13,612,259 barrels/day) was used to estimate emissions from tanks, atmospheric distillation, wastewater treatment, cooling towers, system blowdowns, and flares. The confidence interval for each of these sources was assigned to be  $\pm 5\%$  based on engineering judgment.

The AF used for fuel gas system fugitives was the number of refinery heaters. The number of heaters was taken from a 1993 EPA report entitled *Alternative Control Techniques—NO<sub>x</sub> Emissions from Process Heaters*.<sup>24</sup> An estimate of 3,200 is cited as the number of heaters in the refining industry. An error bound of 50% was assigned based on engineering judgment.

A number of assumptions were used to estimate the AF for refinery engines (20,334 MMhp-hr). First, the energy requirement for each of the refinery process units (reported in BTU/bbl crude)<sup>25</sup> and the volume of crude refined through each unit (based on the activity factors shown in Table 5-8) were used to estimate the total energy required by the refinery. Results of this analysis are shown in Table 5-9. The *Petroleum Supply Annual* reports the volume of fuels consumed in refineries,<sup>26</sup> which can be converted to energy equivalents based on the heat rate of each fuel type,<sup>27</sup> thus representing the total energy consumed at refineries (shown in Table 5-10).

Assuming that the difference between the total energy consumed at refineries and the energy requirements of the various refinery processes is attributed to fuels used to power other engines, the energy input to engines is estimated to be approximately 54E+09 hp-hr (after converting the difference between the totals shown in Tables 5-9 and 5-10 from MMBtu to hp-hr). The EF for engines is expressed in terms of energy output, so an engine efficiency of 33% was estimated on the basis of efficiencies reported in AP-42 for typical gasoline, diesel, and gas operated engines (AP-42, Tables 3.3-2 and 3.2-2).<sup>28</sup> The end result is the energy output from engines used in refineries (approximately 20E+09 hp-hr). A confidence bound of 100% was assigned to this value due to inherent problems associated with the difference between two large values.

TABLE 5-9. 1993 REFINERY ENERGY REQUIREMENTS

Refinery Process	Fuel Usage <sup>a</sup> BTU/bbl crude	Crude Feed Rate <sup>b</sup> bbl/yr	MMBTU/yr
Atmospheric Distillation	100,000	4,974,001,000	497,400,100
Vacuum Distillation	74,900	2,168,696,410	162,435,361
Thermal Operations	88,000	606,990,620	53,415,175
Catalytic Cracking	100,000	1,715,254,720	171,525,472
Catalytic Reforming	320,000	1,201,195,655	384,382,610
Catalytic Hydrocracking	250,000	406,482,615	101,620,654
Catalytic Hydrorefining	70,000	582,882,370	40,801,766
Catalytic Hydrotreating	75,000	2,677,024,975	200,776,873
Alkylation/Polymerization	1,100,000	366,746,890	403,421,579
Aromatics/Isomerization	190,000	253,515,130	48,167,875
Lube Processing	140,000	64,905,030	9,086,704
<b>TOTAL MMBtu/yr</b>			<b>2,073,034,168</b>

<sup>a</sup>Fuel Usage: Radian Corporation, "The Assessment of Environmental Emissions from Oil Refining," July 1980.<sup>25</sup>

<sup>b</sup>Crude Feed Rate: *Oil and Gas Journal*, Annual Refining Report, 1993.<sup>8</sup>

TABLE 5-10. 1993 REFINERY FUEL CONSUMPTION

Fuel Type	Heat Rate <sup>a</sup>	Units	Fuel Usage <sup>b</sup>	Units	MMBTU
Distillate Fuel Oil	5,825	MMBTU/bbl	515,000	bbl	2,999,875
Residual Fuel Oil	6,287	MMBTU/bbl	10,460,000	bbl	65,762,020
Still Gas	6,000	MMBTU/bbl	230,760,000	bbl	1,384,560,000
Natural Gas	1,030	BTU/scf	735,939	MMscf	758,017,170
<b>TOTAL, MMBtu/yr</b>					<b>2,211,339,065</b>

<sup>a</sup>Heat Rate: Energy Information Administration, *Annual Energy Outlook 1995*, 1995.<sup>27</sup>

<sup>b</sup>Fuel Usage: Energy Information Administration, *Petroleum Supply Annual*, 1994.<sup>26</sup>

## 5.2 EMISSION FACTORS - 1993 BASE YEAR

Several of the EFs used in this report were taken from other studies. The GRI/EPA natural gas study is used often. Other referenced reports include API Report 4615,<sup>13</sup> AP-42,<sup>28</sup> and API's *Global Emissions of Methane from Petroleum Sources*.<sup>5</sup> Sometimes the data had to be reprocessed to make them apply to the petroleum industry; these corrections will be discussed below. Data taken directly from existing sources are referenced. Table 5-11 summarizes the emission factors used by this project.

### 5.2.1 Production

The EFs for production are presented below under each major emission type.

#### **Fugitive Emissions—**

Fugitive EFs for offshore platforms for the Gulf of Mexico and the rest of the United States (scfd/platform) come directly from the GRI/EPA natural gas study.<sup>29</sup> EFs from oil wellheads (heavy and light), separators (heavy and light), heater/treaters (light crude), headers (heavy and light), compressors (light crude-small and large), and sales areas, all reported in scfd/source type, are derived from the January 1995 API Report 4615 *Emission Factors for Oil and Gas Production Operations*.<sup>13</sup> A 30% error bound was assumed based on engineering judgment. The API EFs are split into heavy and light crude, since heavier crude has less methane and therefore a lower EF. Fugitive EFs for tanks (light crude, scfd/tank) were also taken from API Report 4615.<sup>13</sup> The underground pipeline fugitive EF and error bound came directly from the GRI/EPA natural gas study.<sup>30</sup> More detail on production fugitive EFs can be found in Appendix E.

#### **Vented Emissions—**

Oil tanks emit methane from the flash that occurs when crude oil is lowered to atmospheric pressure in the tank. Emissions occur through the tank vent to the atmosphere if it is uncontrolled. This is believed to be a much larger source of methane emissions than working or breathing losses from the production tanks. The oil tank EF, scf/bbl, and confidence interval were derived from a 1992 Canadian Petroleum Association (CPA) field measurement study.<sup>31</sup> The Canadian Study showed an average tank emission rate of 12.1 scf CH<sub>4</sub>/bbl. Since tanks are such a large methane emission source, the Canadian data were compared with emission estimates predicted using the ASPEN Plus™\* process simulator. For the simulations, (details provided in Appendix F) methane emissions were estimated from fixed-roof atmospheric pressure oil tanks, assuming that the oil is in equilibrium with a methane stream in a gas/oil separator upstream of the tank. Methane dissolved in the oil at the temperature and pressure of the separator is flashed

---

\*ASPEN Plus™ is a registered trademark of Aspen Technology, Inc.

TABLE 5-11. EMISSION FACTOR SUMMARY

PRODUCTION			Source
<i>Emissions Source Category</i>	<i>Emission Factor</i>		
<b>Fugitive Sources:</b>			
Offshore Platforms - Gulf of Mexico	2914 scfd CH4/platform		GRU/EPA Study <sup>29</sup>
Offshore Platforms - Rest of US	1178 scfd CH4/platform		GRU/EPA Study <sup>29</sup>
Oil Wellheads (heavy crude)	0.83 scfd CH4/well		API 4615 Report <sup>13</sup>
Oil Wellheads (light crude)	19.58 scfd CH4/well		API 4615 Report <sup>13</sup>
Separators (heavy crude)	0.85 scfd CH4/sep		API 4615 Report <sup>13</sup>
Separators (light crude)	51.33 scfd CH4/sep		API 4615 Report <sup>13</sup>
Heater Treaters (light crude)	59.74 scfd CH4/heater		API 4615 Report <sup>13</sup>
Headers (heavy crude)	0.59 scfd CH4/header		API 4615 Report <sup>13</sup>
Headers (light crude)	202.78 scfd CH4/header		API 4615 Report <sup>13</sup>
Tanks (light crude)	34.4 scfd CH4/tank		API 4615 Report <sup>13</sup>
Small Compressors (light crude)	46.14 scfd CH4/compressor		API 4615 Report <sup>13</sup>
Large Compressors (light crude)	16360 scfd CH4/compressor		API 4615 Report <sup>13</sup>
Sales Areas	40.55 scfd CH4/area		API 4615 Report <sup>13</sup>
Pipelines	56.4 scfd CH4/mile		GRU/EPA Study <sup>30</sup>

(Continued)

TABLE 5-11. EMISSION FACTORS BY SEGMENT  
(Continued)

		PRODUCTION		
<i>Emissions Source Category</i>		<i>Emission Factor</i>		<i>Source</i>
<b>Vented Sources:</b>				
Oil Tanks	12.1	scf CH4/bbl		CPA Study <sup>31</sup>
Pneumatic Devices	345	scfd CH4/device		GRI/EPA Study <sup>33</sup>
Chemical Injection Pumps	248	scfd CH4/pump		GRI/EPA Study <sup>34</sup>
Vessel Blowdowns	78	scfy CH4/vessel		GRI/EPA Study <sup>35</sup>
Compressor Starts	8443	scfy CH4/compressor.		GRI/EPA Study <sup>35</sup>
Compressor Blowdowns	3774	scfy CH4/compressor.		GRI/EPA Study <sup>35</sup>
Completion Flaring	733	scfd CH4/completion		GRI/EPA Study <sup>36</sup>
Well Workover	96	scf CH4/workover		PSI Report <sup>14</sup>
Emergency Shutdown (ESD)	256,888	scfy CH4/platform		GRI/EPA Study <sup>35</sup>
Pressure Relief Valve (PRV) Lifts	34	scfy CH4/PRV		GRI/EPA Study <sup>35</sup>
Well Blowout	250,000	scf CH4/blowout		EPA Report <sup>21</sup>
<b>Combustion Sources:</b>				
Gas Engines	0.24	scf CH4/hp-hr		GRI/EPA Study <sup>37</sup>
Burners	0.526	lb CH4/1000 gal		AP-42 <sup>28</sup>
Drilling	0.052	ton CH4/well drilled		1992 API Report <sup>5</sup>

(Continued)



TABLE 5-11. EMISSION FACTORS BY SEGMENT  
(Continued)

CRUDE TRANSPORTATION		
<i>Emission Source Category</i>	<i>Emission Factor</i>	<i>Source</i>
<b>Fugitive Sources:</b>		
Pump Stations	1.06 lb CH <sub>4</sub> /yr/mile	PSI Report <sup>14</sup>
Pipelines	0.0 lb CH <sub>4</sub> /bbl	PSI Report <sup>14</sup>
<b>Vented Sources:</b>		
Tanks	4.37e-07 ton CH <sub>4</sub> /bbl	1992 API Report <sup>5</sup>
Truck Loading	1.02e-05 ton CH <sub>4</sub> /bbl	AP-42 <sup>28</sup>
Marine Loading	0.5 lb CH <sub>4</sub> /1000 gal crude	PSI Report <sup>14</sup>
Rail Car Loading	1.02e-05 ton CH <sub>4</sub> /bbl	AP-42 <sup>28</sup>
Pump Stations	1.56 lb CH <sub>4</sub> /y/station	PSI Report <sup>14</sup>
<b>Combustion Sources:</b>		
Pump engine drivers	0.24 scf CH <sub>4</sub> /hp-hr	GRI/EPA Study <sup>37</sup>

TABLE 5-11. EMISSION FACTORS BY SEGMENT  
(Continued)

REFINING			Source
Source Category	Emission Factor		
<b>Fugitive Sources:</b>			
Fuel Gas System	1.02 MMscf CH <sub>4</sub> /heater		Derived using a 1995 EPA Report <sup>38</sup>
Wastewater Treating	0.00798 lb Volatile Organic Carbon (VOC)/bbl		EPA Report <sup>39</sup>
Cooling Towers	0.01 lb VOC/bbl		AP-42 <sup>28</sup>
<b>Vented Sources:</b>			
Tanks	4.37e-07 ton CH <sub>4</sub> /bbl		1992 API Report <sup>5</sup>
System Blowdowns	580 lb hydrocarbon (HC)/1000 bbl capacity		1977 Radian Report <sup>40</sup>
<b>Combustion Sources:</b>			
Atmospheric Distillation	0.30 lb total hydrocarbon (THC)/1000 bbl		1980 Radian Report <sup>25</sup>
Vacuum Distillation	0.30 lb THC/1000 bbl		1980 Radian Report <sup>25</sup>
Thermal Operations	0.50 lb THC/1000 bbl		1980 Radian Report <sup>25</sup>
Catalytic Cracking	0.43 lb THC/1000 bbl		1980 Radian Report <sup>25</sup>
Catalytic Reforming	0.60 lb THC/1000 bbl		1980 Radian Report <sup>25</sup>
Catalytic Hydrocracking	0.60 lb THC/1000 bbl		1980 Radian Report <sup>25</sup>
Catalytic Hydrorefining	0.18 lb THC/1000 bbl		1980 Radian Report <sup>25</sup>
Catalytic Hydrotreating	0.54 lb THC/1000 bbl		1980 Radian Report <sup>25</sup>
Alkylation & Polymerization	1.05 lb THC/1000 bbl		1980 Radian Report <sup>25</sup>

(Continued)

TABLE 5-11. EMISSION FACTORS BY SEGMENT  
(Continued)

REFINING		
<i>Source Category</i>	<i>Emission Factor</i>	<i>Source</i>
Aromatics/Isomeration	0.15 lb THC/1000 bbl	1980 Radian Report <sup>25</sup>
Lube Processing	0.0	1977 EPA Report <sup>40</sup>
Asphalt	60 lb HC/ton	1977 EPA Report <sup>40</sup>
Hydrogen	0.0	1977 EPA Report <sup>40</sup>
Engines	0.24 scf CH <sub>4</sub> /hp-hr	GRI/EPA Study <sup>37</sup>
Flares	0.0008 lb VOC/bbl	1984 Radian Report <sup>39</sup>

to the vapor phase in the tank. The resulting emissions ranged from 4 to 15 scf CH<sub>4</sub>/bbl, compared with an average of approximately 12 scf CH<sub>4</sub>/bbl from the Canadian study. The Canadian measurements were also compared to tank measurements taken at seven sites as part of a recent API/GRI study.<sup>32</sup> The measurements at the seven U.S. sites ranged from 3.5 to 148 scf CH<sub>4</sub>/bbl, with a mean value of 47.5 scf CH<sub>4</sub>/bbl and median value of 8.6 scf CH<sub>4</sub>/bbl). Since the mean API/GRI emission factor is much higher than the Canadian emission factor, the more conservative Canadian value (12.1 scf/bbl) was used. It is recognized that this factor currently does not account for the use of control devices (such as tank vapor recovery systems on sour gas tanks).<sup>32</sup>

EFs for pneumatic devices, CIPs, vessel blowdowns, compressor starts, and compressor blowdowns (all in scf/equipment type) were taken directly from the respective GRI/EPA natural gas study reports (Pneumatic Device report,<sup>33</sup> CIP report,<sup>34</sup> and Blow and Purge report<sup>35</sup>). Completion flaring, reported as scfd/completion is also from the GRI/EPA natural gas study (Vented and Combustion Summary report).<sup>36</sup> Well workover (scf/workover) is originally from a December 1989 PSI report<sup>14</sup> and is also used in the GRI/EPA natural gas study (Vented and Combustion Summary report).<sup>36</sup> The confidence intervals for each of these sources are based on the confidence intervals calculated in the GRI/EPA natural gas methane emissions study.

Upsets are considered a vented emission source. These consist of emissions from emergency shutdown systems (ESD), PRVs, and well blowouts. The ESD EF, reported as scfy/platform, and methane emissions from PRV lifts, reported scfy/PRV, are both from the GRI/EPA natural gas study (Blow and Purge report).<sup>35</sup> The confidence intervals for these sources are also from the GRI/EPA natural gas study (Blow and Purge report).<sup>35</sup>

The well blowout (scf/blowout) EF is estimated by assuming the quantity of gas released is comparable to the gas production rate of the well (for the GRI/EPA study, the average well production rate was approximately 125,000 scfd/well) and by assuming the duration of the well blowout is 48 hours (a 1977 EPA report provided a range of time from 15 minutes to 5 months but reported that a few days was a typical duration).<sup>21</sup> The confidence bound for this source was assigned based on engineering judgment.

### **Combustion Emissions—**

The EF from gas engines, reported as scf/hp-hr, and the confidence interval are taken from the GRI/EPA natural gas study (Compressor report).<sup>37</sup> AP-42 reports a methane EF for burners in lb/1000 gallons (AP-42, Table 1.3-4).<sup>28</sup> A confidence interval of 10% was assigned to this source. The drilling EF (tons/well drilled) came from a 1992 API report, *Global Emissions of Methane from Petroleum Sources*.<sup>5</sup> The confidence interval was assigned based on engineering judgment.

### **5.2.2 Crude Transportation**

Crude oil is transported from production operations to refineries by tankers, barges, rail tank cars, tank trucks, and pipelines. Confidence intervals for the fugitive and vented EF sources in crude transportation were assigned, based on engineering judgment, for all sources except pump engine drivers. The confidence interval for this source is carried over from the GRI/EPA natural gas study (Compressor report).<sup>37</sup>

#### **Fugitive Emissions—**

The fugitive EF for crude transportation pump stations (lb/mile) is taken from a December 1989 PSI report, *Annual Methane Emission Estimate of The Natural Gas and Petroleum Systems in the United States*.<sup>14</sup> This source also reported that fugitive methane emissions from pipelines are negligible.

#### **Vented Emissions—**

The EF for crude transportation storage tanks (tons/bbl) is based on an EF determined for breathing and working losses of refinery storage tanks from an API project.<sup>5</sup> Methane EFs from storage tanks are not readily available, so the API project simplified some assumptions in order to utilize AP-42 emission estimates. For the purpose of this study, it was assumed that emissions from refinery crude storage tanks would be similar to storage tanks in crude transport. The confidence interval was assigned based on engineering judgment.

Methane emissions for the transportation segment result primarily from the loading of petroleum crude, since vapors in the transportation carriers are displaced to the atmosphere when the crude oil is loaded. EFs reported by AP-42 were used for truck loading (tons/bbl) and rail car loading (tons/bbl).<sup>28</sup> Emissions from marine vessel loading and unloading, lb/1000 gallons crude, are from the same PSI report cited above for pump stations.

An EF for the vented emissions of methane from pump station maintenance, reported in lb/year/station, is taken from the above-cited PSI report, assuming one station per 100 miles of pipeline.<sup>14</sup>

### **5.2.3 Refining**

Methane emissions are not typically reported for refining operations, since methane is not a regulated hazardous air pollutant (HAP). In addition, by the time crude oil has reached the refinery, the volatile hydrocarbons such as methane have already flashed off. Fugitive methane emissions do result from light-end hydrocarbons produced in some of the refinery operations and from the use of natural gas or refinery still gas in burners and engines. For the purpose of this study, reported fugitive emissions of VOC or hydrocarbon were used with assumptions that relate these emissions to methane emissions.

Confidence intervals for all EFs except refinery engines, were assigned based on engineering judgment. The refinery engine confidence interval is carried over from the GRI/EPA natural gas study (Compressor report).<sup>37</sup>

### **Fugitive Emissions—**

The fugitive emissions from refinery fuel gas systems were estimated based on engineering judgment. The component counts of 90 valves and 200 flanges per refinery heater were based on the following assumptions:

- 20 burners per heater;
- Each burner has a pipe run from a blended fuel gas header; and
- Each heater has a fuel gas control valve and metering orifice/differential pressure cell.

The component EFs for valves and flanges were taken from a 1995 EPA report *Protocol for Equipment Leak Emission Estimates*.<sup>38</sup> A methane content of 80 wt% was used.

The fugitive EF for wastewater treatment, reported in lb VOC/bbl, is taken from an EPA test program.<sup>39</sup> AP-42 Table 5.1-2 was the source for the cooling tower EF, also reported as lb VOC/bbl.<sup>28</sup> To convert VOC emissions to methane, the assumption was made that methane makes up 1% of VOC emissions, based on the AP-42 estimate that less than 1% of total hydrocarbon emissions are methane. Confidence bounds for these sources were assigned based on engineering judgment.

### **Vented Emissions—**

Methane emissions from refinery tanks were estimated by using the EF reported for crude transportation (Section 5.2.2). The system blowdown EF, reported as lb HC/1000 bbl capacity, is taken from a 1977 Radian report.<sup>40</sup> To convert from hydrocarbon emissions to methane emissions, a methane composition of 1% was used. A confidence bound was assigned based on engineering judgment.

### **Combustion Emissions—**

Total hydrocarbon emissions (lb HC/1000 bbl crude oil feed) from process heater flue gas emissions were reported for the following refinery processes: atmospheric distillation, vacuum distillation, thermal operations, catalytic cracking, catalytic reforming, catalytic hydrocracking, catalytic hydrotreating, alkylation and polymerization, and aromatics/isomerization. These EFs are taken from a 1980 Radian report.<sup>25</sup>

Total hydrocarbon emissions from combustion sources were converted to methane emissions by assuming a 51% methane composition. This was calculated based on reported methane compositions of emissions resulting from natural gas (AP-42 Table 1.4-3)<sup>28</sup> and fuel oil

combustion (AP-42 Table 1.3-4)<sup>28</sup> in boilers, where the methane component of the emissions was ratioed based on the relative amount of fuel oil versus gas (natural gas or still gas) consumed at refineries.<sup>26</sup>

Methane emissions from lube processing and hydrogen production processes were assumed to be negligible.<sup>40</sup>

The EF for asphalt processes, reported as lb HC/ton of asphalt produced, is taken from a refinery system blowdown emission estimate.<sup>40</sup>

The methane EF developed for production engines, scf/hp-hr, is also used to estimate methane emissions from refinery engines (GRI/EPA Compressor report).<sup>37</sup> The flare EF, reported as lb VOC/bbl, is taken from a 1985 Radian report.<sup>39</sup> As with vented emissions, the methane composition for this source is assumed to be 1% of the reported VOC emissions.

## 6.0 RESULTS—1993 BASE YEAR

Presented below in Sections 6.1 through 6.4 are tables for the 1993 methane emission estimates for production, crude transportation, refining, and the total petroleum industry, respectively. All calculated confidence bounds represent a precision basis only. See Sections 4.3 and 9.0 for bias considerations. Each section shows the largest emission sources for the industry segments considered. Refer to Appendix G for a table that can be used to convert the English system units to metric units.

### 6.1 PRODUCTION

The production segment emitted 87 Bscf of methane in the 1993 base year. Figure 6-1 shows the largest sources by percentage within the production segment. As shown in the figure, oil tank venting, pneumatic devices, fugitives from large compressors, and chemical injection pumps account for over three quarters of the total emissions in the production segment. The detailed 1993 methane emissions estimate for the production segment is presented in Table 6-1.

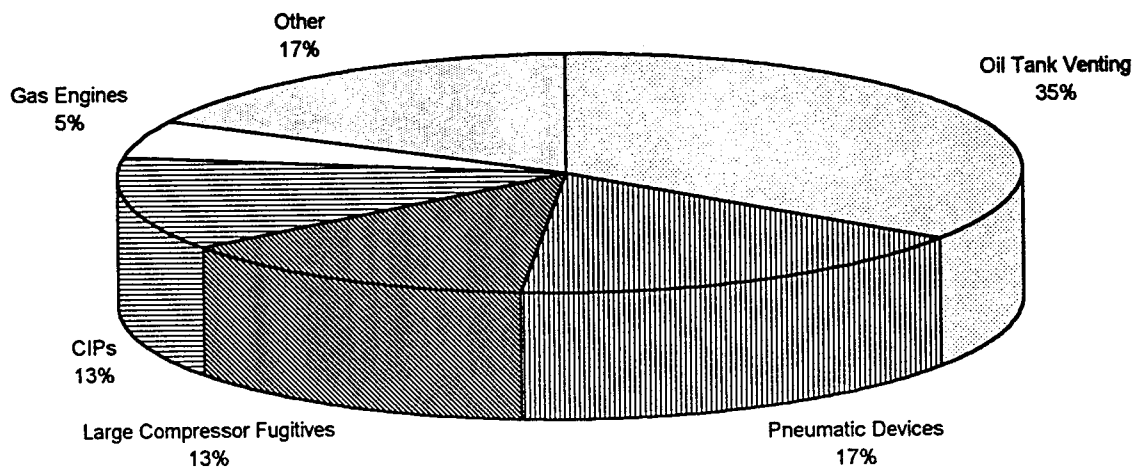

Figure 6-1. Production Segment Largest Emission Sources



Table 6-1. 1993 METHANE EMISSIONS ESTIMATE  
PETROLEUM - PRODUCTION

Emission Source	Emission Factor	Methane Emissions Units	Confidence Interval	Activity Factor	Activity Units	Confidence Interval	Emissions (Bscf)	Confidence Interval
Annual Production				6,846,000	bb/d	5%		
% Heavy Crude (API<20°)				10.7%		100%		
Total Producing Oil Wells				583,879	wells	5%		
% Heavy Wells (API<20°)				7.1%		100%		
<b>Fugitives:</b>								
Offshore Platforms	2914	scfd CH4/platform	27%	1,092	platforms	10%	1.161	29%
Gulf of Mexico	1178	scfd CH4/platform	36%	22	platforms	10%	0.009	38%
Rest of US	0.83	scfd CH4/well	30%	41,163	wells	100%	0.012	109%
Oil Wellheads (heavy crude)	19.58	scfd CH4/well	30%	542,716	wells	100%	3.879	109%
Oil Wellheads (light crude)	0.85	scfd CH4/sep	30%	9,103	separators	78%	0.003	87%
Separators (heavy crude)	51.33	scfd CH4/sep	30%	113,071	separators	78%	2.118	87%
Separators (light crude)	59.74	scfd CH4/heater	30%	77,354	heater treaters	131%	1.687	140%
Heater/Treaters (light crude)	0.59	scfd CH4/header	30%	15,296	headers	109%	0.003	118%
Headers (heavy crude)	202.78	scfd CH4/header	30%	47,291	headers	109%	3.500	118%
Headers (light crude)	34.4	scfd CH4/tank	30%	54,272	tanks	109%	0.681	118%
Tanks (light crude)								
Compressors (light crude)								
Small	46.14	scfd CH4/comp	100%	647	small g.i. comp.	92%	0.011	164%
Large	16,360	scfd CH4/comp	100%	1,940	large g.i. comp.	92%	11.585	164%
Sales Areas	40.55	scfd CH4/area	30%	4,443	sales areas	46%	0.066	57%
Pipelines	56.4	scfd CH4/mile	97%	70,000	miles	50%	1.441	119%
<b>Venting:</b>								
Oil Tanks	12.1	scf CH4/bbl	88%	6,846,000	bb/d	5%	30.235	88%
Pneumatic Devices	345	scfd CH4/device	40%	117,008	pneumatics	78%	14.734	93%
CIPs	248	scfd CH4/pump	83%	125,088	CIPs	105%	11.323	160%
Vessel Blowdowns	78	scfy CH4/vessel	266%	205,870	sep. and h.t.	70%	0.016	333%
Compressor Starts	8443	scfy CH4/comp.	157%	2,799	gas lift comp.	81%	0.024	218%
Compressor Blowdowns	3774	scfy CH4/comp.	147%	2,799	gas lift comp.	81%	0.011	206%
Completion Flaring	733	scfd CH4/completion	200%	390	completions	10%	0.104	201%
Well Workover	96	scf CH4/workover	200%	43,791	w.o./year	421%	0.004	962%
Casinghead Gas								
<b>Upsets:</b>								
ESD	256,888	scfy CH4/plat	200%	1,114	platforms	10%	0.286	201%
PRV Lifts	34	scfy CH4/PRV	252%	422,936	PRV	103%	0.014	376%
Well Blowout	250,000	scf CH4/blowout	200%	2.85	blowouts/yr	200%	0.001	490%
<b>Combustion Sources:</b>								
Gas Engines	0.24	scf CH4/HPHr	5%	17,634	MMhp-hr	277%	4.232	277%
Burners	0.526	lb CH4/1000 gal	10%	3,647,000	bb/year	5%	0.002	11%
Drilling	0.052	ton CH4/well drilled	100%	390	expl. wells	10%	0.001	101%
Flares								
<b>Total</b>							87.14	48.3%

## 6.2 CRUDE TRANSPORTATION

The crude transportation segment emitted 1.4 Bscf of methane in the 1993 base year. Figure 6-2 shows the largest sources by percentage within the crude transportation segment. Marine unloading and tank venting account for the majority of emissions. The detailed 1993 emission estimate for crude transportation is shown in Table 6-2.

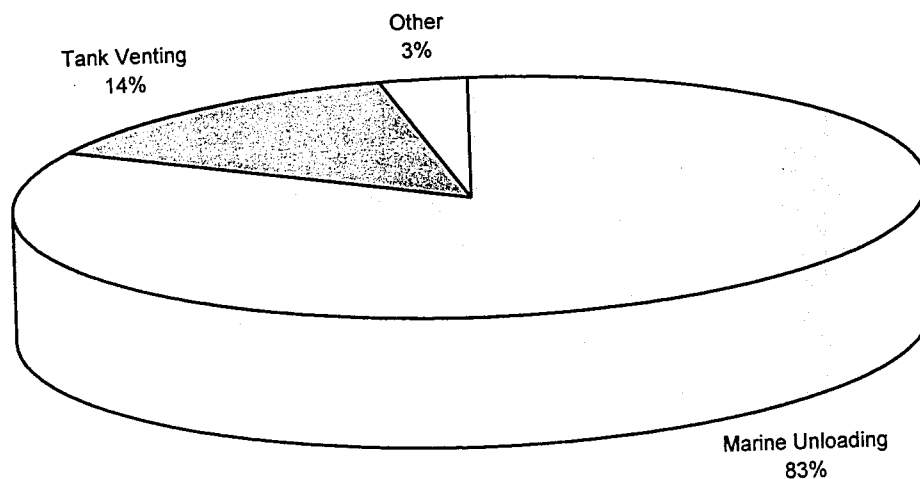

Figure 6-2. Crude Transportation Segment Largest Emission Sources

**TABLE 6-2. 1993 METHANE EMISSION ESTIMATE  
PETROLEUM - CRUDE TRANSPORTATION**

Emission Source	Emission Factor	Methane Emissions Units	Confidence Interval	Activity Factor	Activity Units	Confidence Interval	Emissions (Bscf)	Confidence Interval
<b>Fugitives:</b>								
Pump Stations	1.06	lb CH4/yr/mile	100%	55,268	miles	100%	0.0014	173%
Pipelines	0.0	lb CH4/bbl	10%	6.71E+09	bbl/yr	5%	0.0000	11%
Metering								
<b>Venting:</b>								
Tanks	4.37E-07	ton CH4/bbl	100%	9.07E+09	bbl/yr	4%	0.188	100%
<b>Loading</b>								
Truck	1.02E-05	ton CH4/bbl	100%	7.69E+07	bbl/yr	10%	0.037	101%
Marine	0.5	lb CH4/1000 gal crude	100%	9.54E+10	gal/yr	10%	1.132	101%
Rail Car	1.02E-05	ton CH4/bbl	100%	8.91E+06	bbl/yr	10%	0.004	101%
<b>Maintenance:</b>								
Pump Stations	1.56	lb CH4/y/station	100%	553	stations	100%	0.000	173%
<b>Combustion Sources:</b>								
Pump engine drivers	0.24	scf CH4/HPhr	5%					
Heaters								
<b>Total</b>							1.362	85.1%

### 6.3 REFINING

The refining segment emitted 9.2 Bscf of methane in the 1993 base year. Figure 6-3 shows the largest sources by percentage within the refining segment. Engine exhaust emissions and fugitive emissions account for the majority of emissions. The detailed 1993 methane emissions estimate for the refining segment is presented in Table 6-3.

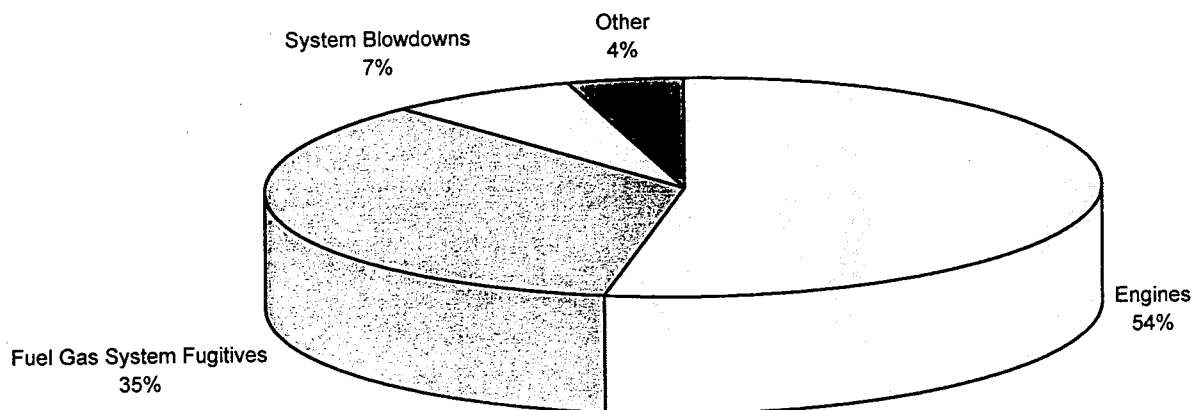

Figure 6-3. Refining Segment Largest Emission Sources

**TABLE 6-3. 1993 METHANE EMISSION ESTIMATE  
PETROLEUM - REFINING**

Emission Source	Emission Factor	Methane Emissions Units	Confidence Interval	% Methane in THC*	Activity Factor	Activity Units	Confidence Interval	Emissions (Bscf)	Confidence Interval
<b>Fugitives:</b>									
Fuel Gas System	1.02	MMscf CH4/heater/yr	100%		3,200	heaters	50%	3.26	122%
Pipe Stills									
Wastewater Treating	0.00798	lb VOC/bbl	100%	1.0%	13,612,259	b/d	5%	0.009	100%
Cooling Towers	0.01	lb VOC/bbl	100%	1.0%	13,612,259	b/d	5%	0.012	100%
<b>Venting:</b>									
Tanks	4.37E-07	ton CH4/bbl	100%		13,612,259	b/d	5%	0.103	100%
System Blowdowns	580	# HC/1000 bbc capacity	100%	1.0%	13,612,259	b/d	5%	0.684	100%
Process Vents									
Upsets									
PRVs									
<b>Combustion Sources:</b>									
Process Heaters:									
Atm. Distillation	0.30	lb THC/1000 bbl	100%	51.0%	13,612,259	b/d	5%	0.018	100%
Vacuum Distil.	0.30	lb THC/1000 bbl	100%	51.0%	5,935,032	b/d	5%	0.008	100%
Thermal Operations	0.50	lb THC/1000 bbl	100%	51.0%	1,661,140	b/d	5%	0.004	100%
Cat. Cracking	0.43	lb THC/1000 bbl	100%	51.0%	4,694,106	b/d	5%	0.009	100%
Cat. Reforming	0.60	lb THC/1000 bbl	100%	51.0%	3,287,291	b/d	5%	0.009	100%
Cat. Hydrocracking	0.60	lb THC/1000 bbl	100%	51.0%	1,112,414	b/d	5%	0.003	100%
Cat. Hydrorefining	0.18	lb THC/1000 bbl	100%	51.0%	1,595,163	b/d	5%	0.001	100%
Cat. Hydrotreating	0.54	lb THC/1000 bbl	100%	51.0%	7,326,166	b/d	5%	0.018	100%
Alkyl & Polymer.	1.05	lb THC/1000 bbl	100%	51.0%	1,003,670	b/d	5%	0.005	100%
Aromatics/Isomeration	0.15	lb THC/1000 bbl	100%	51.0%	693,791	b/d	5%	0.000	100%
Lube Processing	0.0		100%		177,624	b/d	5%	0.000	100%
Asphalt	60	# HC/ton	100%	51.0%	631,440	b/d	5%	0.167	100%
Hydrogen	0.0		100%					0.000	100%
Coke	0	Included in Thermal Ops	100%					0.000	100%
Engines and Flares									
Engines	0.24	scf CH4/hp-hr	5%		20,334	MMhp-hr	100%	4.880	100%
Flares	0.0008	lb VOC/bbl	100%	1.0%	13,612,259	b/d	5%	0.001	100%
<b>Total</b>								9.191	69.2%

\* % Methane in VOC (volatile organic compounds) taken from AP-42 (Reference 28)  
 % Methane in HC (hydrocarbons) for system blowdowns is taken from AP-42  
 % Methane in THC (total hydrocarbons) calculated based on data from AP-42  
 % Methane in HC for asphalt calculated based on data from AP-42

## 6.4 TOTAL INDUSTRY

The total petroleum industry (production, crude transportation, and refining) emitted 98 Bscf of methane in the 1993 base year. Presented below is Table 6-4, the 1993 methane emissions estimate for all three industry segments combined. Figure 6-4 shows the emissions by type, and Figure 6-5 shows the total industry percentage of emissions attributable to each segment. As shown in Figure 6-4, vented emissions are the largest type of emission. When emissions are presented by segment, the production segment accounts for the vast majority of all emissions.

TABLE 6-4. 1993 PETROLEUM METHANE EMISSION ESTIMATE—TOTAL OF THREE INDUSTRY SEGMENTS

Segment	Annual Emissions, Bscf
Production	87.1 ± 48%
Crude Transportation	1.36 ± 85%
Refining	9.19 ± 69%
TOTAL	97.7 ± 44%

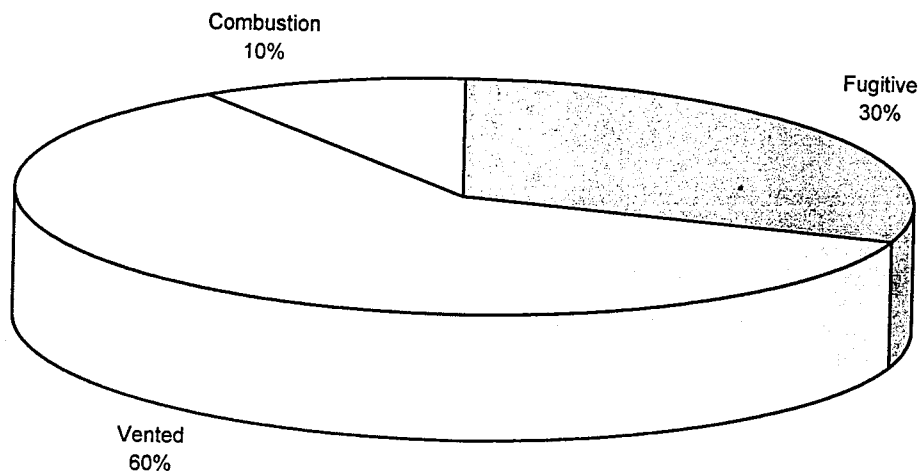

Figure 6-4. Emissions by Type

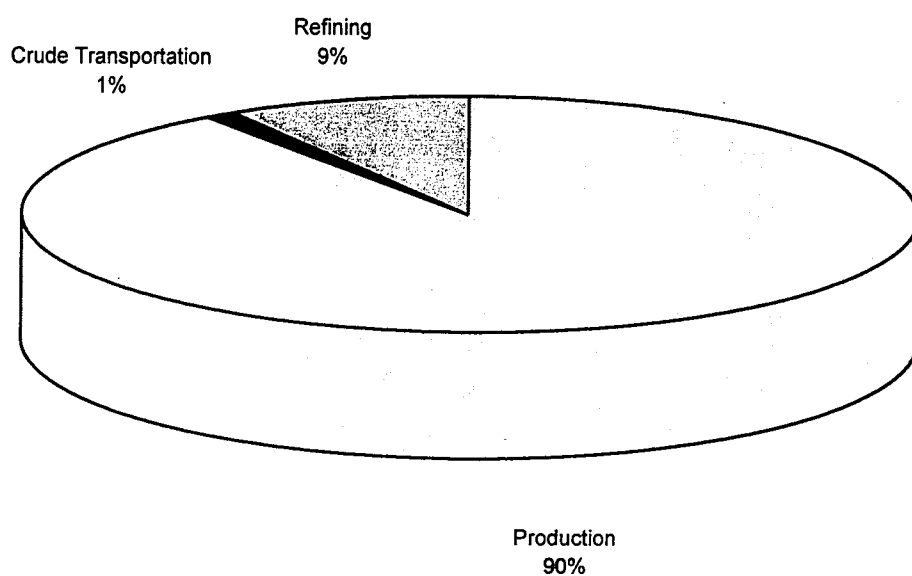

Figure 6-5. Percent Emissions by Segment

## **7.0 METHANE EMISSIONS—1986-1992**

After the base-year emission estimate was constructed for 1993, estimates were made to cover the years 1986 through 1992. It should be noted that the 1986 through 1992 estimates have the same limitations that apply to the 1993 estimate. Section 7.1 covers the methods used to make the historical estimates, and the results are presented in Section 7.2.

### **7.1 METHOD FOR HISTORICAL ESTIMATES**

Activity (AFs) and emission factors (EFs) were examined for potential changes that could have occurred between 1986 and 1993. AFs, such as well count and crude production rates, were known to have changed during the period. However, potential changes to EFs required analysis. Potential EF changes could have resulted from maturing domestic production fields, technology changes in all segments, operating and maintenance practices in all segments, and applied emission controls. An analysis of these potential EF effects reveals that none of these factors had a significant impact on emissions. Therefore, EFs are assumed to have remained unchanged from 1986 to 1993, as explained in the following paragraphs.

Minimal technology changes or changes due to maturing fields are assumed to have occurred from 1986 to 1993, since the oil production and domestic refining industry was already very mature (over 50 years old) in 1986. Some maturing oil fields may have required additional artificial lift over this period, where an increased use of gas lift would contribute to higher emission rates. However, there is no method available to estimate those changes over the period, and they were assumed to be negligible. In general, most capital investment of energy production companies in production and refining has been overseas since the mid-1980s, which reduces the application of new technologies domestically, especially technology that would affect emission rates. Therefore, these potential technology factors are believed to have had little or no impact on EFs.

The primary operating practices that could affect EFs are leak detection and repair (LDAR) programs, which minimize fugitive emissions, and maintenance changes that affect gas equipment blowdowns. LDAR programs did not exist in the production or crude transportation segments during the 1986 to 1993 period. LDAR programs began in refineries in the 1980s, since many were located in non-attainment urban areas. However, refinery LDAR programs do not target methane, so refinery fuel gas systems, the primary source of refinery methane emissions in this study's estimate, would not be affected. Maintenance practices, the primary element of which is compressor blowdown, are also assumed to have remained constant during this time period. Therefore, these potential operating practice changes had little or no impact on EFs.

For this study, it was assumed that applied emission controls were not in use or had no effect during the 1986 to 1993 period. Although EPA's Maximum Achievable Control Technology (MACT) standards will soon require control technologies for some of the petroleum industry, they were not in effect during the 1986 to 1993 time period. Even when MACT



standards do become official and enforced, their effect on methane emissions is not certain, since the MACT is aimed at other hazard air pollutants (HAPs), not methane.

On the basis of this analysis, EF changes during the 1986 to 1993 time period are negligible. The primary method for reverse estimates to 1986 was to use known changes in AFs. In the production segment, the primary AFs are oil wells and oil production rate, which are known for each year in the 1986 to 1993 period.<sup>12,15</sup> The well count and production rate are also used to extrapolate the production segment equipment counts from the site visit data. These activity factors therefore changed the equipment counts over the period, even though the site visit data set remained unchanged. Completion wells and wells drilled were also known and changed over that time period.<sup>19,41</sup> The number of well workovers was based on the total number of wells.<sup>12</sup>

In the crude transportation segment, the AFs for the volume of crude transported by mode of transportation was known for each year and was therefore adjusted over the 1986 to 1993 period.<sup>11,22</sup>

In the refinery segment, the crude charge rate and the utilization factor were known for each year and were therefore adjusted over the 1986 to 1993 period.<sup>15,42</sup> The refinery engine AF was not adjusted for each year. Instead, the value reported for 1993 is based on an average of the values that resulted for each year, accounting for the energy requirements for the various refinery processes and the energy equivalent of the fuel consumed at refineries for each year (shown in Table 7-1 and based on calculations presented in Section 5.1.5).

TABLE 7-1. REFINERY ENGINE ACTIVITY FACTOR FOR 1986-1993.

Year	Refinery Energy Requirements, MMBtu	Refinery Fuel Consumption, MMBtu	Refinery Engine Activity Factor, MMhp-hr
1993	2.071E+09	2.211E+09	18,221
1992	2.007E+09	2.213E+09	26,780
1991	1.964E+09	2.175E+09	27,410
1990	2.080E+09	2.199E+09	15,441
1989	2.058E+09	2.159E+09	13,118
1988	2.021E+09	2.135E+09	14,814
1987	1.911E+09	2.049E+09	17,857
1986	1.877E+09	2.101E+09	29,032
Average Refinery Engine Activity Factor, MMhp-hr			20,334

This AF is based on the difference between two large numbers, such that a small difference in either the refinery fuel usage or refinery energy usage for a particular year has a large impact on the estimated engine fuel use AF. Owing to the uncertainties resulting from the calculation approach for this AF and because this is a large emission source, the results were

misleading. For example, the AF difference between 1986 and 1993 would result in a decrease in refinery emissions of approximately 2.6 Bscf from this single source. Since the year to year change in hp-hrs is believed to be due only to year to year errors in fuel use, the hp-hr value was held constant across the years examined.

These AF changes were used in the estimation of methane emissions for 1986 through 1992, the results of which are shown in the following section.

## 7.2 RESULTS

Table 7-2 provides a summary of the total emissions by industry segment for each year of this study. Appendix H (Tables H-1 through H-21) show the detailed emission results for the years 1986 through 1992 of this study. The net emissions changed very little over the period: There were 110.1 Bscf of emissions in 1986, compared with 97.7 Bscf of emissions in 1993. Production segment emissions were actually higher in 1986, due to the larger number of domestic oil wells and oil production rate in 1986.

TABLE 7-2. EMISSION SUMMARY FOR 1986-1993.

Methane Emissions, Bscf				
Year	Production	Transportation	Refining	Total
1993 (Base Year)	87.1	1.36	9.19	97.7 ± 43.6%
1992	89.6	1.32	9.19	100.1 ± 43.8%
1991	92.6	1.30	9.12	103.0 ± 44.0%
1990	91.3	1.28	9.19	101.8 ± 43.9%
1989	92.7	1.30	9.19	103.2 ± 44.0%
1988	96.1	1.26	9.18	106.5 ± 44.3%
1987	97.8	1.18	9.13	108.1 ± 44.5%
1986	99.8	1.11	9.12	110.0 ± 44.7%

## 8.0 CONCLUSIONS

As presented in Section 6, the total methane emissions estimate from the U.S. petroleum industry is 98 Bscf for the base year 1993. This estimate is believed to be accurate to approximately +/- 100%. Accuracy, which is comprised of precision and bias components, cannot be rigorously calculated, given the limitations of the data. While precision of the estimate for 90% confidence bounds was calculated to be only +/- 44%, there may be some unquantified bias resulting from use of the limited data set. Possible contributors to bias are listed in Section 4.3 and Section 9.0 of this report. This bias can be ruled out or corrected in the following phases of effort. Figure 8-1 shows the relative contribution of the petroleum segment to the total anthropogenic emissions of methane in the United States, based on methane emission estimates from EPA<sup>1</sup> and GRI/EPA sources.<sup>2</sup> According to this 1998 EPA study, petroleum sources could account for 3 to 4 times as much methane as estimated previously by EPA (both the April 1993 and November 1995 reports).<sup>4,1</sup> The updated higher emission estimates presented here still only account for less than 1% of total greenhouse gas emissions, when CO<sub>2</sub> emissions are considered.<sup>1</sup>

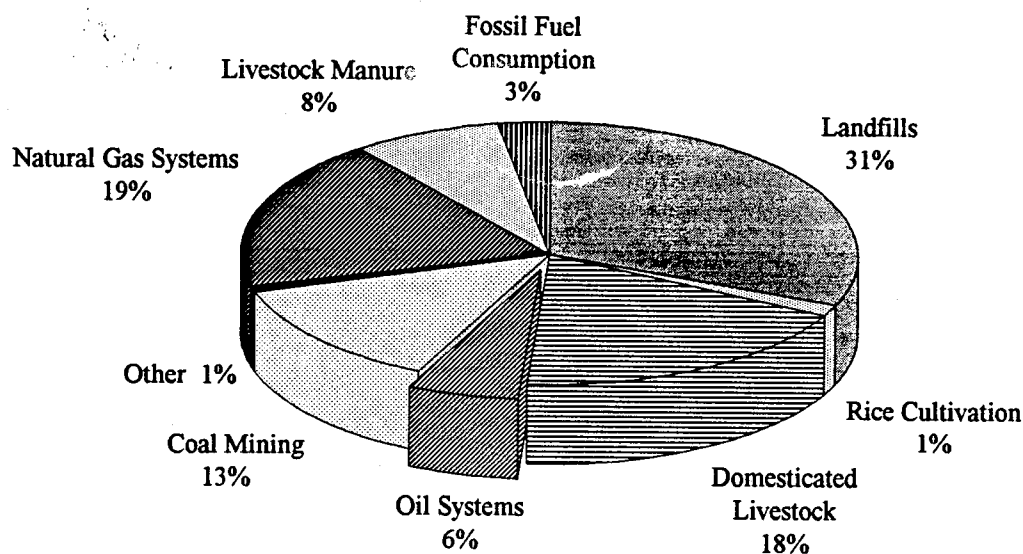

Figure 8-1. Sources of Anthropogenic Methane Emissions (Updated)

Table 8-1 shows methane emission estimates for the U.S. petroleum industry from four previous studies compared to this 1996 EPA-ORD study.

TABLE 8-1. ANNUAL METHANE EMISSION ESTIMATES FOR U.S. PETROLEUM INDUSTRY FROM FIVE DIFFERENT STUDIES (Bscf)

	Base Year of Report	Production	Crude Transportation	Refining	Total
API, 1992 <sup>5</sup>	1987-1989	0.6	0.8	4.5	<b>5.9</b>
API, 1996 <sup>6</sup>	1990	38.9	0.5	0.7	<b>40.1</b>
EPA, 1993 <sup>4</sup>	1990	6.1 - 25.3 <sup>a</sup>	0.3	0.5	<b>6.9-26.1</b>
EPA, 1995 <sup>1</sup>	1993	6.1 - 25.3 <sup>a</sup>	0.3	0.5	<b>6.9-26.1</b>
EPA, 1998	1993	87.1	1.4	9.2	<b>97.7</b>

<sup>a</sup> Production segment includes field fugitive emissions, field routine maintenance emissions, crude oil storage facility emissions, and venting and flaring.

The 1992 API study provided a global estimate using the base years 1987 to 1989.<sup>5</sup> The 1996 API report provided an updated estimate for 1990 methane emissions.<sup>6</sup> The 1996 study is higher primarily due to adding tank emissions. Both studies included these three segments:

- Production;
- Crude transportation; and
- Refining.

The 1993 EPA study presented an estimate for all U.S. sources of manmade methane emissions.<sup>4</sup> Of these sources, the study estimated petroleum emissions to be approximately 1.1% of total methane emissions, or between 6.9 and 26.1 Bscf per year. The study accounted for six sources of petroleum emissions:

- Production field fugitive emissions;
- Production field routine maintenance emissions;
- Crude oil storage facility emissions;
- Refineries;
- Marine vessel operations; and
- Venting and flaring.

The EPA numbers came from various sources, including a 1991 draft report of the GRI/EPA natural gas study. For comparative purposes, the six sources listed above were regrouped into production, crude transportation, and refining.

The 1995 EPA study presented all greenhouse gas emissions and sources.<sup>1</sup> The 1995 EPA study directly used the results of the 1993 EPA study.<sup>4</sup> The report states that anthropogenic methane constitutes approximately 11.3% of total greenhouse gas emissions. Petroleum emissions were divided into the same six categories as in the 1993 EPA study.

This 1998 EPA-ORD study provides an initial estimate that is more detailed than other previous efforts. While it may have some biases, the previous reports were also biased in the use of broader, more general estimates that did not address all possible emission sources. In fact, the previous studies did not perform data gathering nor measurements, and none used an equipment level of detail. Instead, broad segment-wide emission factors were used, which tend to underestimate emissions.

Although measurements were not performed in this study, this report does draw on new measurements unavailable prior to this effort, such as measurements made for the GRI/EPA natural gas study. This 1998 EPA report also uses new detailed data, such as the production site visit database, that allow equipment level AF estimates that were not possible previously.

The 1992 API study was limited to the use of a few broad assumptions, and identified only a few of the sources of methane emissions in the industry. The 1996 API study primarily used the United Nations Intergovernmental Panel on Climate Change (IPCC) Greenhouse Gas Protocol,<sup>43</sup> which has a generic, undetailed method of estimating methane emissions that ignores some known sources. In fact, the major difference between the estimates in the first and second API study is that the second study added production tank emissions to the IPCC protocol.

The 1993 and 1995 EPA studies are identical, since the 1995 study relies entirely on the 1993 study. These two EPA studies were not performed on an equipment detail level; thus, many sources were overlooked, such as production tank flash emissions, compressor fugitive emissions, CIPs, refinery fuel gas systems, compressor exhaust emissions, etc. The reports also used a “vented and flared” term that has since been shown to have some data quality concerns (see the Vented and Combustion Summary Report of the GRI/EPA natural gas study).<sup>36</sup>

The conclusion from comparison of previous efforts to this effort is therefore that the emissions from the petroleum industry may be much higher than previously estimated. Further study will be required to verify this initial conclusion. The results of this project show a confidence bound of  $\pm 43.6\%$ . In reality, this confidence bound represents precision only. As discussed in Section 3, there is an assumption in any project that the bias term in accuracy is zero. However, there are some potential biases that have been identified, which, if real, would change the emission estimate. Many of these potential biases are discussed in Section 9 on future efforts.

If these emission data are ultimately used to analyze the global warming impact of emissions associated with domestic consumption of oil, it may be necessary in the future to add an analysis of foreign emissions from the production of oil imported into the United States. This would raise the total emissions associated with U.S. oil consumption. In addition, it may be necessary to add emissions from downstream segments, refined product transportation, marketing, and end use, so that a total life-cycle analysis is included in the global warming analysis.

## **9.0 FUTURE EFFORTS**

This report attempts to improve upon earlier methane emission estimates for the petroleum industry by examining emission sources on an equipment level of detail. However, the basis for this Phase I estimate can be improved in future efforts. This section outlines key assumptions and key data issues, and provides recommendations for future updates. As with any analysis, if key assumptions are incorrect, the estimate could be biased to some degree. All the assumptions are believed to be reasonable and correct, but the estimates should only be used as guidelines for further study. Additional field data gathering, field measurement programs, and data analysis could eliminate potential bias issues and lead to improved accuracy in future refinements.

Key data issues are also identified where the data set is small, and where a larger data set would add confidence to the overall estimate. This is the case for many items in this report, since no measurement efforts were conducted for this study.

Sections 9.1 through 9.3 serve as a sensitivity analysis on the key issues for each segment of the industry. In general, the current estimate is highly sensitive to the assumptions listed in the following sections. The recommendations in Section 9.4 can be used to develop future improvement projects.

### **9.1 PRODUCTION SEGMENT KEY ISSUES AND ASSUMPTIONS**

Production segment key issues are described below. Each paragraph presents a new issue and its potential impact. There are key assumptions that, if incorrect and then corrected, would increase the emission estimate, and others that would decrease the emissions estimate. Some issues require further efforts, while others do not. Recommendations regarding these key issues are summarized in Section 9.4.

Production emissions resulted primarily from four major sources:

- 1) Oil tanks;
- 2) Pneumatic devices;
- 3) Large compressor fugitive emissions; and
- 4) Chemical injection pumps.

Therefore the estimate is very sensitive to assumptions that affect these categories.

Production segment AFs were assumed to be bounded by the definition of the petroleum segment industry boundaries shown in Figure 3-2. This report used the identical production segment boundaries defined in the GRI/EPA natural gas study. This approach ensures that when the results of this study are combined with the results from the GRI/EPA natural gas study, all production segment emissions are counted and none are double-counted. Selection of these boundaries directly affects the equipment counts that are attributed to the petroleum industry.

The limited site visit data set used to generate production equipment count AFs is not assumed to be completely representative of the United States petroleum production segment. For example, the production rate per well is high in the sampled data set compared to the known production rate per well, and there is an over-representation of gas-lift sites and offshore oil wells. Major limitations in the existing site database include the following:

- 1) A complete set of equipment counts was not available for all of the sites;
- 2) The limited database lacks information to stratify data based on regional differences or operational differences (e.g., differences between equipment associated with heavy versus light crude production or differences in equipment associated with stripper wells);
- 3) The production data set was not generated by a random sample, but instead from oil sites coincidentally visited during the GRI/EPA natural gas industry study.

A more detailed site data collection effort was not conducted in this Phase 1 study. Therefore, adjustments were made to the existing production data for use in this study (described further in Section 5.1.2). For most equipment, the data set extrapolation was corrected by using an arithmetic mean of the equipment counts determined by well count versus production rate. In addition, a correction factor was applied to the extrapolated count of gas-lift compressors, which if determined to be not appropriate, could increase the total emission by 25.7 Bscfy for the base year 1993.

Other potential production site sampling biases could significantly lower the estimate. For example, the majority of oil wells in the United States are low production rate, marginally profitable wells called stripper wells. The field activity factor data set did include stripper wells with pneumatic devices and chemical injection pumps supplied by natural gas pressure. If these were not representative of typical stripper wells, then future phases would estimate lower emissions from these two sources.

Most production AFs (equipment types) are assumed to be related to both well count and production rate. Extrapolating by well counts produces a much higher AF than the production extrapolation. If future technical analysis could prove the exact relation between the equipment counts and well counts or production rate, the AF estimates would change.

This report has extrapolated production AFs using the “ratio method” specified in the GRI/EPA natural gas study (Statistical Methods report).<sup>9</sup> In order to be consistent with the GRI/EPA natural gas study, this project has used the identical extrapolation method. Although this method is believed to be the appropriate technique, the method weights large sites (sites with many wells and more production per well) more than small sites. If this technique were incorrect, the AF estimates and the emissions could change.

This project has assumed that the available data on heavy crude versus light crude production from 1976-1981 are applicable to the years 1986 through 1993. Fugitive equipment

counts (for wellheads, separators, heater/treaters, headers, tanks, and gas lift compressors) were split between those with heavy crude production and light crude production, since there are different published emission factors for each type (i.e., higher EFs for light crude production). If the ratio of heavy crude production to total production for the time period of this project is significantly different than that during 1976-1981, then the emission estimates would change.

Large gas compressors in the petroleum industry (particularly production) were assumed to have the same characteristics as compressors in gas transmission, which were measured in the GRI/EPA natural gas study. Large compressors (those with similar equipment setups as transmission compressor stations) were found to have very high fugitive emissions in the gas industry. However, no emission measurements of large compressors in production are readily available. If large production compressors were not similar to transmission compressors, emissions could be more than 11.5 Bscf lower. In addition, this report has assumed that 75% of the compressors in the production segment are large compressors, based on the fact that most of these are gas lift compressors, and several industry sources believed that all were large, housed stations, or gas plants. If these assumptions were incorrect, the emission estimate would be affected.

This report's production data set contained compressors primarily associated with gas lift. If there is a large number of compressors associated with other artificial lift methods, such as CO<sub>2</sub> flood, then the combustion and fugitive emissions associated with compressors would increase.

The 30 Bscf of oil tank emissions are the largest single source of emissions in production, so any bias in this category will have a very large effect. In fact, the tank-vented EF is based on a Canadian program consisting of only five measurements.<sup>31</sup> If this was an inaccurate sample, the emission estimate would change.

Some miscellaneous emission sources were assumed to be negligible and are not currently accounted for by any national system. Negligible sources in production include vented casinghead gas, vented oil well gas production, and burner and flare flame-out (these sources are listed in Table 6-1, but no EFs or AFs were estimated). If these assumptions were incorrect, emissions would increase.

## **9.2 CRUDE TRANSPORTATION SEGMENT KEY ISSUES AND ASSUMPTIONS**

Transportation is a small contributor to methane emissions. Therefore the key issues in transportation are relatively minor compared with production. Recommendations regarding some of these issues are summarized in Section 9.4.

No AF was estimated for pump engine drivers, owing to lack of data. Combustion emissions from gas engines in the production and refining segments were significant. Therefore, this source for transportation could also be significant.



The pipeline station count AF was based on an assumption of one station per 100 miles.<sup>14</sup> If this were incorrect, the emission estimate would have to be changed. In addition, the number of intrastate pipeline miles and the volume of crude transported by intrastate pipelines are not included in the estimated number of miles, number of pump stations, and volume of crude transported by pipelines. Accounting for the intrastate pipelines would increase the emission estimates.

Pipeline fugitive methane emissions are assumed negligible based on past reports and oil industry experience. Metering and heaters were also identified as emission sources in Table 6-2, but are believed to be negligible. If this were incorrect, the emission estimate would increase.

### **9.3 REFINING SEGMENT KEY ISSUES AND ASSUMPTIONS**

This project assumed that there are no significant fugitive emissions of methane in the refinery except in the fuel gas system. This is based on an assumption that the only significant concentration of methane in the refinery is in the fuel gas system. However, other units that handle or generate light ends (such as pipe stills and light end units) may have methane in concentrations high enough to generate measurable methane emissions.

This project has assumed that there is no methane in atmospheric process vents at the refinery. Therefore, no methane EFs or AFs were estimated for pipestills, process vents and PRVs. If this were incorrect, the emission estimate would increase.

The largest estimated source of methane emissions in the refinery is from gas engine exhaust (unburned fuel). This project has assumed that engine fuel use in the refinery can be calculated by an energy balance of all fuel driven process equipment. Currently the estimate is based on fuel usage by refineries minus the amount accounted for by heat input to process heaters. By difference, an estimated fuel use for compressors results. On a national basis, the accuracy of this estimate is limited by the inherent problems associated with the difference between two large values. Since this is the largest emission source in refineries, an error in this method could lead to a significant difference in the estimated emissions.

A national composition of methane in the refinery was estimated for fugitive emissions. The assumption that methane comprises 1% of VOC emissions was used, which could be conservatively high since AP-42 suggests that the methane component of total hydrocarbon emissions is *less* than 1%.<sup>28</sup> The methane composition of combustion sources was estimated to be 51%, based on the relative quantities and compositions of the various refinery fuels.<sup>28</sup> If more exact average compositions were determined in the future, this might decrease emissions.

### **9.4 RECOMMENDED FUTURE TEST PLAN**

Future efforts aimed at improving the estimate presented in this report should center on data gathering, measurement, and data analysis. An initial approach to data gathering might be to

establish a voluntary industry review panel that would provide data, provide sites for measurement, and occasionally meet to review the underlying assumptions and work produced.

As was mentioned in Section 8, a general trend observed in methane emission estimates is that estimates that lack supporting data tend to underestimate emissions. Over time, as detailed activity data and emission measurements are taken, the estimates rise and plateau when a more accurate answer is reached. This is similar to a learning curve effect. This has been the experience with the projects estimating methane emissions from the gas industry, and this trend is also reflected in methane emissions for the petroleum industry as shown in Table 8-1.

This project shows that the production segment has emissions an order of magnitude higher than the combined emissions from refining and transportation. Although this relative comparison is probably accurate, it should be noted that the production segment has the most data available, and therefore may be further along the learning curve of emission estimates. Although it is tempting to concentrate all future efforts in the segment of the industry showing the highest current estimate, such action may prevent the project from reaching a reasonable degree of accuracy in all the segments. The sampling philosophy established for the GRI/EPA-ORD natural gas industry project was to focus on large emission categories and large uncertainties. The philosophy even involved establishing target accuracies for every single source category. This requires an assumption that all of the sources are well known and that all that is required is refinement of precision. This petroleum industry project currently has considerably less data than the gas industry project, and still has some bias concerns. Therefore the petroleum project cannot adopt a detailed target accuracy sampling approach.

This report recommends that some additional work be conducted in each petroleum industry segment. The following subsections identify specific AF and EF data gathering efforts for each segment of the industry. The additional work will allow unknown sources to be discovered.

#### **9.4.1 Production Segment Improvements**

The production segment of the industry has the highest emissions of methane. The following descriptions list recommendations in order of importance.

##### **Activity Factor Site Visits—**

One of the most important issues in the production segment is to eliminate potential biases in the production site visit database. This can be accomplished by collecting additional production site data, based on randomly selected sites across the nation. These sites may be provided by the volunteer participants in the industry panel mentioned earlier, or may be directly solicited by a future project team. Company databases, if available from other efforts such as air permit emissions programs, could also be employed where offered. Another sampling goal would be to add regions of the United States as a strata for the AFs, and sample oil production

sites within those regions. The key regions identified during the gas industry production segment could be used for this analysis.

A sampling plan can be established from the regional approach or by using a recognized oil industry database. Although using a database could be an expensive approach, it would be the most robust. This would require further investigation.

### **Compressor Measurements—**

Another key issue is the large compressor EFs and AFs. Since emissions from large production compressors have never been measured, a recommended future action is to conduct a production field fugitive sampling effort for compressors using screening and direct measurement devices. In addition, site visit efforts can concentrate on additional oil production sites and/or use company databases that verify whether the assumed fraction of large compressors is correct.

### **Tank Measurements—**

Production tank vented emissions, which account for approximately 31% of the total 1993 industry emissions estimate, should be refined in the future. While this can be accomplished through additional field measurements, sampling programs are very expensive and time intensive, and the wide variability resulting from field characteristics could make representative sampling difficult. Therefore, tank vented emissions can best be updated by a modeling and activity data gathering effort.

To support a future tank emission update effort, national activity data on crude production should be gathered as input to a tank emissions modeling program.<sup>32</sup> The activity data should include the following:

- 1) Stratification of crude production in the U.S. into homogeneous groups (or regions) of similar API gravity, Reid Vapor Pressure, and sweetness;
- 2) Average separator pressures and temperatures for the same groups; and
- 3) Average tank controls applied for each group.

The results of such a modeling effort could then be used to replace the current estimate of national methane emissions from oil tanks.

### **Miscellaneous—**

For improved fugitive estimates, the split of light and heavy crude production should be updated. Some national databases on production parameters exist, but are proprietary and often require the user to purchase the database. Alternatively, state data can be examined. The Texas Railroad Commission reports similar data for their oil leases, which could be used to determine a

light and heavy crude split. Likewise, if the other states with heavy crude production track this information, each state's data could be analyzed to update the data or validate the assumptions.

#### **9.4.2 Crude Transportation Segment Improvements**

Crude transportation is estimated to be a small contributor to methane emissions, but some additional work is recommended. First, a better characterization of the crude transportation segment should be made. For example, the characterization should define exactly what types of equipment are associated with crude transportation terminals, pipeline pump stations, vessel and car loading, and unloading terminals. These data are not currently available. Also, a more accurate count of pipeline miles (including intrastate mileage) may be available from a national Geographic Information System (GIS) database, such as the Pennwell Map database.

#### **9.4.3 Refining Segment Improvements**

Current estimates indicate that refining is a relatively small contributor to methane emissions. However, very little information of methane emissions from refineries exists, and therefore most emission estimates from refineries are based on simplifying assumptions identifying one or two potential sources of methane. Future efforts should center on characterizing refinery units for potential fugitive emissions as well as potential point source emissions.

If refineries participate in future efforts, they may be able to provide component speciation data for individual process vents in refineries. Although methane is not a regulated pollutant, and therefore may not be measured directly, methane concentrations might have been measured by difference, since total hydrocarbon (THC) and non-methane hydrocarbon (NMHC) concentrations are often determined.

Future efforts can update the fugitive emissions estimate by validating this project's fuel gas system component count assumptions. Obtaining actual fuel gas system counts from participating companies may be possible, since these companies may have produced counts for their air permit emission inventories. In addition, overlooked sources for fugitives may be added if participating companies add methane to fugitive emissions data gathering efforts for refineries in specific areas where methane is expected (fuel gas, light ends, pipe stills).

Finally, data could be collected from participating refiners on gas-driven compressor counts and compressor fuel usage to validate the assumptions made by this report. Data for estimating methane emissions from internal combustion engines used at refineries may also be available through a national emissions inventory database used to track other air emissions.

## 10.0 REFERENCES

1. U.S. Environmental Protection Agency. *Inventory of U.S. Greenhouse Gas Emissions and Sinks: 1990-1994*, EPA-230/R-96-006 (NTIS PB96-175997). Office of Policy, Planning and Evaluation, Washington, DC, November 1995.
2. Harrison, M.R., L.M. Campbell, T.M. Shires, and R.M. Cowgill. *Methane Emissions from the Natural Gas Industry, Volume 2: Technical Report*, Final Report, EPA-600/R-96-080b (NTIS PB97-142939). U.S. Environmental Protection Agency, Air Pollution Prevention and Control Division, Research Triangle Park, NC, June 1996.
3. Hileman, B. "Climate Observations Substantiate Global Warming Models," *Chemical & Engineering News*, November 27, 1995, pp. 18-25.
4. U.S. Environmental Protection Agency. *Anthropogenic Methane Emissions in the United States Estimates for 1990*, Report to Congress. EPA-430-R-93-003. Office of Air and Radiation, Washington, DC, April 1993.
5. Radian Corporation. *Global Emissions of Methane From Petroleum Sources*. American Petroleum Institute, Health and Environmental Affairs Department, Report No. DR140, February 1992.
6. Harrison, M.R. and T.M. Shires. *Methane and Carbon Dioxide Emission Estimates from U.S. Petroleum Sources*, Final Report. API Publication 4845. American Petroleum Institute, January 1997.
7. Stapper, B.E. *Methane Emissions from the Natural Gas Industry, Volume 5: Activity Factors*, Final Report, EPA-600/R-96-080e (NTIS PB97-142962). U.S. Environmental Protection Agency, Air Pollution Prevention and Control Division, Research Triangle Park, NC, June 1996.
8. Bell, L. "Worldwide Refining - Survey of Operating Refineries in the U.S. (State Capacities as of January 1, 1994)." *Oil and Gas Journal*, December 20, 1993, p. 50.
9. Williamson, H.J., M.B. Hall, and M.R. Harrison. *Methane Emissions from the Natural Gas Industry, Volume 4: Statistical Methodology*, Final Report, EPA-600/R-96-080d (NTIS PB97-142954). U.S. Environmental Protection Agency, Air Pollution Prevention and Control Division, Research Triangle Park, NC, June 1996.
10. Cochran, William G. *Sampling Techniques*, Third Edition, New York, NY: John Wiley & Sons, 1977.
11. True, W.R., "U.S. Interstate Pipelines Ran More Efficiently in 1994." *Oil and Gas Journal*, November 27, 1995, p. 56.

12. World Oil, "Producing Oil Well Numbers Still Dropping." *World Oil*, February 1994, p. 70.
13. Star Environmental. API Report No. 4615. *Emission Factors for Oil and Gas Production Operations*. American Petroleum Institute, January 1995.
14. Tilkicioglu, B.H. and D.R. Winters. *Annual Methane Emission Estimate of The Natural Gas And Petroleum Systems in the United States*. Pipeline Systems Incorporated (PSI), December 1989.
15. Beck, R.J. "Economic Growth, Low Prices to Lift U.S. Oil and Gas Demand in 1995." *Oil and Gas Journal*, January 30, 1995, pp. 54-64.
16. Interstate Oil Compact Commission (IOCC). *Major Tar Sand and Heavy Oil Deposits of the United States*. IOCC, Oklahoma City, OK, 1984.
17. Clegg, Joe D., S. Mike Bucaram, and N.W. Hein, Jr. *Recommendations and Comparisons for Selecting Artificial-Lift Methods*. *Journal of Petroleum Technology*, pp. 1128-1131, 1163-1167. 1993.
18. ICF Inc. *Estimation of Activity Factors for Gas E&P Facilities*, Final Report. U.S. Environmental Protection Agency, Office of Air and Radiation, Washington, DC, July 12, 1995.
19. Energy Information Administration (EIA). *Annual Energy Review 1994*, "Table 4.5 Oil and Gas Exploratory Wells, 1949-1994." EIA, Office of Oil and Gas, U.S. Department of Energy, DOE/EIA-0384(94), Washington, DC, July 1995.
20. Energy Information Administration (EIA). *Petroleum Supply Annual 1993 Volume 1*, "Table 2. U.S. Supply, Disposition, and Ending Stocks of Crude Oil and Petroleum Products, 1993." EIA, Office of Oil and Gas, U.S. Department of Energy, Washington, DC, May 1994.
21. Braxton, C., R.H. Stephens, and M.M. Stephens. *Atmospheric Emissions from Offshore Oil and Gas Development and Production*. EPA-450/3-77-026 (NTIS PB 272-268). U.S. Environmental Protection Agency, Office of Air Quality Planning and Standards, Research Triangle Park, NC, June 1977.
22. Energy Information Administration (EIA). *Petroleum Supply Annual 1993 Volume 1*, "Table 46. Refinery Receipts of Crude Oil by Method of Transportation by PAD District, 1993." EIA Office of Oil and Gas, U.S. Department of Energy, Washington, DC, May 1994.

23. Beck, R.J. "Economic Growth to Raise U.S. Oil Products, Natural Gas Demand." *Oil and Gas Journal*, January 31, 1994, p. 55.
24. Sanderford, E.B. *Alternative Control Techniques—NO<sub>x</sub> Emissions from Process Heaters*. EPA-453/R-93-034 (NTIS PB94-120235). U.S. Environmental Protection Agency, Office of Air Quality Planning and Standards, Research Triangle Park, NC, September 1993.
25. Wetherold, R.G., and D.D. Rosebrook. *Assessment of Atmospheric Emissions from Petroleum Refining. Volumes 1, 2, 3, 4, 5*. EPA-600/2-80-075a--075e (NTIS PB80-225253, 80-225261, 80-225279, 81-103830, and 80-225287), 1980.
26. Energy Information Administration (EIA). *Petroleum Supply Annual 1993 Volume 1*, "Table 47. Fuels Consumed at Refineries by PAD District, 1993." EIA, Office of Oil and Gas, U.S. Department of Energy, Washington, DC, May 1994.
27. Energy Information Administration (EIA). *Annual Energy Outlook 1995*, Appendix I, p. 173, Washington, DC, 1995.
28. U.S. Environmental Protection Agency. *Compilation of Air Pollutant Emission Factors: Volume I: Stationary Point and Area Sources*, AP-42 (GPO 055-000-005-001), Office of Air Quality Planning and Standards, Research Triangle Park, NC, Fifth Edition, January 1995.
29. Hummel, K.E., L.M. Campbell, and M.R. Harrison. *Methane Emissions from the Natural Gas Industry, Volume 8: Equipment Leaks*, Final Report, EPA-600/R-96-080h (NTIS PB97-142996). U.S. Environmental Protection Agency, Air Pollution and Prevention Control Division, Research Triangle Park, NC, June 1996.
30. Campbell, L.M., M.V. Campbell and D.L. Epperson. *Methane Emissions from the Natural Gas Industry, Volume 9: Underground Pipelines*, Final Report, EPA-600/R-96-080i (NTIS PB97-143002). U.S. Environmental Protection Agency, Air Pollution and Prevention Control Division, Research Triangle Park, NC, June 1996.
31. Picard, D.J., B.D. Ross, and D.W.H. Koon. *A Detailed Inventory of CH<sub>4</sub> and VOC Emissions from Upstream Oil and Gas Operations in Alberta Volume III: Results of the Field Validation Program*. Canadian Petroleum Association, March 1992.
32. Radian International LLC. *Evaluation of a Petroleum Production Tank Emission Model*, Final Report. GRI-97/0117, American Petroleum Institute and Gas Research Institute, May 1997.

33. Shires, T.M. and M.R. Harrison. *Methane Emissions from the Natural Gas Industry, Volume 12: Pneumatic Devices*, Final Report, EPA-600/R-96-080l (NTIS PB97-143036). U.S. Environmental Protection Agency, Air Pollution Prevention and Control Division, Research Triangle Park, NC, June 1996.
34. Shires, T.M. *Methane Emissions from the Natural Gas Industry, Volume 13: Chemical Injection Pumps*, Final Report, EPA-600/R-96-080m (NTIS PB97-143044). U.S. Environmental Protection Agency, Air Pollution Prevention and Control Division, Research Triangle Park, NC, June 1996.
35. Shires, T.M. and M.R. Harrison. *Emissions from the Natural Gas Industry, Volume 7: Blow and Purge Activities*, Final Report, EPA-600/R-96-080g (NTIS PB97-142988). U.S. Environmental Protection Agency, Air Pollution Prevention and Control Division, Research Triangle Park, NC, June 1996.
36. Shires, T.M. and M.R. Harrison. *Methane Emissions from the Natural Gas Industry, Volume 6: Vented and Combustion Source Summary*, Final Report, EPA-600/R-96-080f (NTIS PB97-142970). U.S. Environmental Protection Agency, Air Pollution Prevention and Control Division, Research Triangle Park, NC, June 1996.
37. Stapper, C.J. *Methane Emissions from the Natural Gas Industry, Volume 11: Compressor Driver Exhaust*, Final Report, EPA-600/R-96-080k (NTIS PB97-143028). U.S. Environmental Protection Agency, Air Pollution Prevention and Control Division, Research Triangle Park, NC, June 1996.
38. Epperson, D.L. *Protocol for Equipment Leak Emission Estimates, 1995*. EPA-453/R-95-017 (NTIS PB96-175401). U.S. Environmental Protection Agency, Office of Air Quality Planning and Standards, Research Triangle Park, NC, November 1995.
39. Wetherold, R.G., G.E. Harris, F.D. Skinner, and L.P. Provost. *Model for Evaluation of Refinery and Synfuels VOC Emission Data*. Vol. I, EPA-600/7-85-022a (NTIS PB85-215713). U. S. Environmental Protection Agency, Industrial Environmental Research Laboratory, Research Triangle Park, NC, May 1985.
40. Burklin, C.E. *Revision of Emission Factors for Petroleum Refining*. EPA-450/3-77-030 (NTIS PB275-685). U.S. Environmental Protection Agency, Office of Air Quality Planning and Standards, Research Triangle Park, NC, October 1977.
41. Energy Information Administration (EIA). *Natural Gas Production Responses to a Changing Market Environment*. EIA, Office of Oil and Gas, U.S. Department of Energy, DOE/EIA-0532, Washington, DC, May 1990.
42. Bell, L. *Survey of Operating Refineries in the U.S.* *Oil and Gas Journal*, Annual Refinery Report, December 1986-1992. (One issue for each year).



43. Intergovernmental Panel on Climate Change (IPCC). *Greenhouse Gas Inventories: IPCC Guidelines for National Greenhouse Gas Inventories*. United Nations Environment Programme, the Organization for Economic Co-operation and Development, the International Energy Agency, and IPCC, Vols 1-3, Braknell, U.K. 1995.



**APPENDIX A**

**Results of Literature Search**

## APPENDIX A LITERATURE SEARCH RESULTS

A comprehensive methodology review was conducted for this project to identify all previous studies that have produced estimates or studies that have described methodologies for estimating methane emissions for the petroleum industry. Information was gathered from internal sources, an extensive on-line literature search, and contacts with key experts. The literature search covered the time period from 1975 to the present. The keyword search strategy was formed using combinations of the following:

Oil/petroleum industry	Methane emissions
Oil/petroleum refineries/refining	Greenhouse gases
Exploration/production	VOC (volatile organic compound) emissions
Oil/petroleum transportation	Hydrocarbon emissions
	Emissions

As shown, the keywords chosen were fairly general, such that as many possible sources remotely related to emissions from the petroleum industry would be identified. Extensive abstract listings were reviewed to identify all sources applicable to this study. A total of 54 reports (listed in Table A-1) were identified as potentially having some applicability to emissions from the petroleum industry.

**TABLE A-1. LITERATURE SEARCH RESULTS**

References/Resources
Arthur D. Little. <i>Methane Emissions from the Oil and Gas Production Industries</i> . Final Report. Reference No. 63193. Ruhrgas A.G., July 1989.
American Petroleum Institute. <i>Atmospheric Hydrocarbon Emissions from Marine Vessel Transfer Operations</i> , American Petroleum Institute Publication 2514A, Washington DC, 1981.
American Petroleum Institute. <i>Basic Petroleum Data Book: Petroleum Industry Statistics</i> . Volume VII, Number 3, Washington DC, September 1987.
American Petroleum Institute. "Evaporative Loss from Fixed-Roof Tanks", API Bulletin 2518, <i>API Manual of Petroleum Measurement Standards</i> . First Edition, Washington DC, March 1993.
American Petroleum Institute. <i>Hydrocarbon Emissions From Refineries</i> . Publication No. 928. American Petroleum Institute, Committee on Refinery Environmental Control, Washington DC, July 1973.
Bell, L. "Worldwide Refining - Survey of Operating Refineries in the U.S. (State Capacities as of January 1, 1990)," <i>Oil &amp; Gas Journal</i> , March 26, 1990, p. 78.
Burklin, C.E. and R.L. Honercamp, <i>Revision of Evaporative Hydrocarbon Emission Factors</i> , Final Report. EPA-450/3-76-039 (NTIS PB 267-659), U.S. Environmental Protection Agency, Office of Air Quality Planning and Standards, Research Triangle Park, NC, August 1976.

(Continued)

TABLE A-1. (Continued)

References/Resources
Burklin, C.E. <i>Revision of Emission Factors for Petroleum Refining</i> , EPA-450/3-77-030 (NTIS PB 275-685), U.S. Environmental Protection Agency, Office of Air and Waste Management, Research Triangle Park, NC, October 1977.
DeLuchi, M.A., "Emissions from the Production, Storage, and Transport of Crude Oil and Gasoline," <i>Journal of Air and Waste Management Association</i> , November 1993, Volume 43, pp. 1486-1495.
Dubose, D.A., J.I. Steinmetz, and G.E. Harris, <i>Onshore Production of Crude Oil and Natural Gas: Fugitive Volatile Organic Compound Emission Sources - Data Analysis Report Frequency of Leak Occurrence and Emission Factors for Natural Gas Liquid Plants</i> . EMB Report No. 80-FOL-1, U.S. Environmental Protection Agency, Office of Air Quality Planning and Standards, Research Triangle Park, NC, July 1982.
Energy Information Administration. <i>Emissions of Greenhouse Gases in the United States 1987-1994</i> . DOE/EIA-0573(87-94), Energy Information Administration, Office of Integrated Analysis and Forecasting, Washington DC, October 1995.
Energy Information Administration. <i>Natural Gas Production Responses to a Changing Market Environment, 1978-1988</i> . DOE/EIA-0532. Energy Information Administration, Office of Oil and Gas, Washington DC, 1989.
Energy Information Administration. <i>Petroleum Supply Annual, 1993</i> , Volumes 1 and 2, DOE/EIA-0340(93)/1, Energy Information Administration, Washington DC, June 1994.
Espenshade, S.A. and G. Rhines. "The Oil and Natural Gas Producing Industry in Your State," <i>Petroleum Independent</i> . Independent Petroleum Association of America, Washington DC, September 1993.
Frazier, N.A., D.L. Maase, and R. Clark, <i>Offshore Oil and Gas Extraction - An Environmental Review</i> , EPA-600/7-77-080 (NTIS PB 272242), Industrial Environmental Research Lab, Resource Extraction and Handling Division, Cincinnati, OH, July 1977.
Gibbs, M.J., P. Hathiramani, and M. Webb, <i>Fugitive Methane Emissions From Oil and Gas Production and Processing Facilities: Emissions Factors Based on the 1980 API-Rockwell Study</i> . ICF Consulting Associates and STAR Environmental, Universal City, CA, April 1992.
Intergovernmental Panel on Climate Change. <i>IPCC Guidelines for National Greenhouse Gas Inventories: Volume 3 Greenhouse Gas Inventory Reference Manual</i> . United Nations Environment Programme, the Organisation for Economic Co-operation and Development, the International Energy Agency, and the Intergovernmental Panel on Climate Change. Braknell, UK, 1995.
Interstate Oil & Gas Compact Commission. <i>History of Production Statistics: Production and Reserves 1971-1991</i> . Oklahoma City, OK, 1992.
Klett, M.G., and J.B. Galeski, <i>Flare Systems Study</i> , EPA-600/2-76-079, (NTIS PB 251-664), U.S. Environmental Protection Agency, Industrial Environmental Research Laboratory, Research Triangle Park, NC, March 1976.
Kuuskraa, V.A. and M.L. Godec, <i>A Technical and Economic Assessment of Domestic Heavy Oil</i> . Interstate oil Compact Commission, Oklahoma City, OK, 1987.

(Continued)

**TABLE A-1. (Continued)**

<b>References/Resources</b>
LaFlam, G.A , <i>Revision of Marine Vessel Evaporative Emission Factors</i> , Pacific Environmental Services, Inc., Durham, NC, November 1984.
LaFlam, G.A., S. Osbourn, and R.L. Norton, <i>Revision of Tank Truck Loading Hydrocarbon Emission Factors</i> , Pacific Environmental Services, Inc., Durham, NC, May 1982.
Lemlin, J.S., and I. Graham-Bryce, "The Petroleum Industry's Response to Climate Change: The Role of the IPIECA Global Climate Change Working Group," <i>UNEP Industry and Environment</i> , January-March, 1994, pp. 27-30.
Lipton, S., "Fugitive Emissions," <i>Chemical Engineering Progress</i> , June 1989, Volume 85, Number 6, pp. 42-47.
Mussig, S., <i>Possibilities for Reduction of Emissions - in Particular the Greenhouse Gases CO<sub>2</sub> and CH<sub>4</sub> - in the Oil and Gas Industry</i> . Society of Petroleum Engineers, Presented at the European Petroleum Conference, Cannes, France, November 16-18, 1992.
Pennwell Publishing Company. <i>Oil and Gas Journal Databook, 1990 Edition</i> . Tulsa, OK, March 1990.
Picard, D.J., B.D. Ross and D.W.H. Koon. <i>A Detailed Inventory of CH<sub>4</sub> and VOC Emissions From Upstream Oil And Gas Operations in Alberta</i> . Canadian Petroleum Association, Calgary, Alberta, March 1992.
Radian Corporation. <i>Assessment of Atmospheric Emissions from Petroleum Refining: Volumes 1-4</i> . EPA-600/2-80-075a through EPA-600/2-80-075d (NTIS PB 80-225253, PB 80-225261, PB 80-225279, and PB 81-103830). U.S. Environmental Protection Agency, Industrial Environmental Research Laboratory, Research Triangle Park, NC, July 1980.
Radian Corporation. <i>Development of Fugitive Emission Factors and Emission Profiles for Petroleum Marketing Terminals, Volumes 1 and 2</i> . American Petroleum Institute, Washington DC, May 1993.
Radian Corporation. <i>Global Emissions of Carbon Dioxide From Petroleum Sources</i> , American Petroleum Institute Health and Environmental Affairs, Departmental Report Number DR 141, Washington DC, July 1991.
Radian Corporation. <i>Global Emissions of Methane From Petroleum Sources</i> , American Petroleum Institute Health and Environmental Affairs, Departmental Report Number DR 140, Washington DC, February 1992.
Radian Corporation. <i>Oil and Gas Field Emission Survey</i> , Final Report, EPA-600/R-92-083, U.S. Environmental Protection Agency, Air and Energy Engineering Research Laboratory, Research Triangle Park, NC, May 1992.
Radian International LLC. <i>Methane Emissions from the Natural Gas Industry, Volumes 1-15</i> , Final Report. EPA 600/R-96-080a through EPA 600/R-96-080o (NTIS PB 97-142921, etc.). Gas Research Institute and U.S. Environmental Protection Agency, June 1996.
Reister, D.B. <i>An Assessment of the Contribution of Gas to the Global Emissions of Carbon Dioxide (February-December 1983)</i> , Final Report. Oak Ridge Associated Universities, Institute for Energy Analysis, GRI-84/0003. Gas Research Institute, Research and Development Operations Division, Chicago, IL, June 1984.

(Continued)

**TABLE A-1. (Continued)**

<b>References/Resources</b>
Rosebrook, D.D., R.G. Wetherold, and L.P. Provost, <i>The Development of Fugitive Emission Factors for the Petroleum Refining Industry</i> , Presented at the 72nd Annual Meeting of the Air Pollution Control Association, Cincinnati, OH, June 24-29, 1979.
Rosenberg, E.S., <i>Impact of the "HON" Rule on the Petrochemicals and Refining (Industries)</i> . National Petroleum Refiners Association. Presented at the 1993 NPRA Annual Meeting, San Antonio, TX, March 21-23, 1993.
Shah, A. And P. Pope, <i>Methods for Estimating Atmospheric Emissions from E&amp;P Operations</i> . Report No. 2.59/197, E&P Forum, London, UK, September 1994.
Braxton, C., R.H. Stephens, and M.M. Stephens. <i>Atmospheric Emissions from Offshore Oil and Gas Development and Production</i> , Energy Resources Company. EPA 450/3-77-026 (NTIS PB 272268), Environmental Protection Agency, Office of Air and Waste Management, Research Triangle Park, NC, June 1977.
Taback, H.J., G. Lauer, L.K. Gilmer, and K. Ritter, <i>Strategies for Improving HAP Emission Factors and Profiles for the Petroleum Industry</i> , Presented at the 85th Annual Meeting and Exhibition of the Air and Waste Management Association, Kansas City, MO, June 21-26, 1992.
Taback, H.J. and K. Ritter, <i>1994 Fugitive Emissions Estimating Data for Petroleum Industry Equipment Leaks</i> , Presented at the Air and Waste Management Association and California Air Resources Board 5th Annual West Coast Regional Specialty Conference, Sacramento, CA, November 9-10, 1994.
Tilkicioglu, B.H. <i>Annual Methane Emission Estimate of the Natural Gas Systems in the United States</i> . Radian Corporation, EPA Prime Contract No. 68-02-4288. Austin, TX, September 1990.
U.S. Department of Commerce. <i>1992 Census of Mineral Industries: Crude Petroleum and Natural Gas</i> . MIC92-1-13A, U.S. Department of Commerce Economics and Statistics Administration, Washington DC, April 1995.
Harris, G.E., K.W. Lee, S.M. Dennis, C.D. Anderson and D. L. Lewis. <i>Assessment of VOC Emissions from Well Vents Associated With Thermally Enhanced Oil Recovery</i> , EPA-909/9-81-003 (NTIS PB-82-134750), Region 9, San Francisco, CA, September 1981.
U.S. Environmental Protection Agency. <i>Compilation of Air Pollutant Emission Factors: Volume I Stationary Point and Area Sources</i> , AP-42, (GPO 055-000-005-001), U.S. Environmental Protection Agency, Office of Air Quality Planning and Standards, Fifth Edition, January 1995.
U.S. Environmental Protection Agency. <i>Development Document for Effluent Limitations Guidelines and Standard for the Petroleum Refining Point Source Category (Proposed)</i> , U.S. Environmental Protection Agency Effluent Guidelines Division, Washington DC, December, 1979.
U.S. Environmental Protection Agency. <i>Estimating Air Toxics Emissions From Coal and Oil Combustion Sources</i> , EPA-450/2-89-001 (NTIS PB89-194229), Research Triangle Park, NC, April 1989.

(Continued)

**TABLE A-1. (Continued)**

<b>References/Resources</b>
U.S. Environmental Protection Agency, <i>Emissions of Producing Oil and Gas Wells</i> , EPA-908/4-77-006 (NTIS PB 283-279), Region 8, Denver, CO, November 1977.
U.S. Environmental Protection Agency. <i>Independent Quality Assurance of Refinery Fugitives Testing By Western States Petroleum Association</i> . Final Audit Report. EPA-454/R-93-033 (NTIS PB 94-131232), U.S. Environmental Protection Agency, Office of Air Quality Planning and Standards, Research Triangle Park, NC, September 1993.
U.S. Environmental Protection Agency. <i>Inventory of U.S. Greenhouse Gas Emissions and Sinks: 1990-1994</i> . EPA-230-R-96-006 (NTIS PB 96-175997). U.S. Environmental Protection Agency, Office of Policy, Planning and Evaluation, Washington DC, November 1995.
Viswanath, R.S., and J. H. Van Sandt, <i>Oilfield Emissions of Volatile Organic Compounds</i> , EPA-450/2-89-007 (NTIS PB 89-194286), U.S. Environmental Protection Agency, Office of Air Quality Planning and Standards, Research Triangle Park, NC, April 1989.
U.S. Environmental Protection Agency. <i>Options for Reducing Methane Emissions Internationally Volume 1: Technological Options for Reducing Methane Emissions</i> , Report to Congress, EPA 430-R-93-006, Environmental Protection Agency, Office of Air and Radiation, Washington DC, July 1993.
Webb, M. And P. Martino, <i>Fugitive Hydrocarbon Emissions from Petroleum Production Operations</i> , Presented at the 85th Annual Meeting and Exhibition of the Air and Waste Management Association, Kansas City, MO, June 21-26, 1992.
Wetherold, R.G., G.E. Harris, F.D. Skinner, and L.P. Provost. <i>A Model for Evaluation of Refinery and Synfuels VOC Emission Data: Volumes 1 and 2</i> . Final Report. EPA-600/7-85-022a/b (NTIS PB 85-215713 and PB 85-215721) U.S. Environmental Protection Agency, Air and Energy Engineering Research Laboratory, Research Triangle Park, NC, September 1984.
World Meteorological Organization. <i>Climate Change, 1990</i> . Intergovernmental Panel on Climate Change, United Nations Environment Programme, 1990.

Each report was reviewed for industry boundary definitions (i.e., which equipment types of emission sources were considered part of the petroleum industry), level of detail, representativeness, comprehensiveness, and data quality. As a secondary goal of this project, the studies were also searched for VOC emission estimates; however, the scope of the project was later revised to focus only on methane emissions. A summary worksheet and emission source checklist were used to simplify the report review process, so that the information from each report could be summarized in a consistent format. A blank summary worksheet and emission source checklists for each industry segment are shown in Tables A-2 and A-3, respectively.



**TABLE A-2. METHODOLOGY REVIEW - SUMMARY SHEET**

<b>REPORT/STUDY</b>	
Report Title:	
<b>BOUNDARIES</b>	
US Specific?	
Petroleum Industry	
<b>DETAIL LEVEL/COMPREHENSIVENESS</b>	
EF and/or AF Estimate	
Industry Segment (Production, Transportation, Refinery)	
Equipment Type	
<b>REPRESENTATIVENESS</b>	
Based on Petroleum Industry?	
Specific to Methane	
Specific to VOCs	
Other (THC) - What's required to generate methane EF?	
<b>DATA QUALITY</b>	
Year(s)	
Data Basis - Measurements, guess?	
Are modifications required to use data?	
Accuracy - Can it be calculated, guessed?	
Data Quality Ranking or Estimate	
<b>COMMENTS</b>	

**TABLE A-3. EMISSION SOURCE CHECKLIST/SUMMARY**

<b>PRODUCTION</b>	
Overall Site Emission Estimate	
Tanks	
Flares - Well completion	
Fugitives	
Separators	
Heaters	
Compressors	
Metering/Sales	
Wells	
Pipeline	
Pumps	
Offshore Platforms	
Heaters	
Burner	
Vent	
Pneumatic Devices	
Chemical Injection Pumps	
Compressor Exhaust - Gas Lift	
Maintenance	
Vessel Blowdown	
Well Workovers	
Compressor Starts	
Metering/Sales	
Heaters	
Pumps	
Upsets	
Pressure Relief Valves	
ESD/EBD	
Other Engines	
Other	

(Continued)

**TABLE A-3. Continued**

<b>TRANSPORTATION</b>	
Overall Emission Estimate	
Tanks	
Heaters	
Pumps	
Fugitives - Pipeline Pump Station Components	
Loading/Unloading	
Tank Cars	
Rail Cars	
Barges	
Pneumatic Devices	
Maintenance	
Upsets	
Fuel Consumption	Mobile source or end use - not considered here.
Other	

<b>REFINING</b>	
Overall Site Emission Estimate	
Atmospheric Crude Distillation	
Vacuum Crude Distillation	
Naphtha Hydrotreating	
Middle Distillate Hydrotreating	
Gas Oil Hydrotreating	
Vacuum Resid. Hydrodesulfurization	
Catalytic Reforming	
Aromatics Extraction	
Catalytic Cracking	
Hydrocracking	
Thermal Cracking	
Delayed Coking	
Fluid Coking	
Light Ends Recovery & Fractionation	
Other Fractionation	

(Continued)

**TABLE A-3. Continued**

Alkylation	
Polymerization	
Isomerization	
Lube Oil Processing - Solvents	
Other Lube Oil Processing	
Asphalt Production	
Hydrogen Production	
Gasoline Treating	
Other Product Treating	
Olefins Production	
Other Volatile Petrochemicals	
Low Volatility Petrochemicals	
Blowdown System	
Wastewater Collection & Treating	
Sludge/Solids Handling	
Storage - Fixed Roof Tanks	
Storage - Floating Roof Tanks	
Cooling Towers	
Loading	
Combustion Sources	
Boiler	
Flares	
Heaters	
Compressor/Engine	
Tower	
Maintenance	
Pneumatics	
Other	

After completing the worksheets and checklists for each report, a database was set-up to rank the reports on the basis of the criteria listed above. The database facilitated maintaining a record of any emission factors and activity factors for each source category available in each report. This provided a mechanism to quickly scan the available resources and identify data gaps where emission factors or activity factor data did not exist. By using the database, the reports were sorted by industry segment (production, transportation, and refining) and ranked based on their applicability. The database results are shown in Tables A-4 through A-7, where Table A-4 presents a summary of the reports, and Tables A-5 through A-7 are the more detailed databases corresponding to each industry segment.

On the basis of the review of existing literature, it became clear that emission factors did not exist in sufficient form to fully characterize methane emissions from the petroleum industry. Many sources simply did not report methane emissions. As a result of this analysis, the project scope shifted from an emission inventory compilation to one in which methane emission factor and activity factors were developed and estimated.

TABLE A-4a. SUMMARY OF REPORT DATABASE

Report Title	U.S. Specific?	Petroleum Industry Based?	EF and/or AF Estimate	Industry Segment	Emission Source	Emission Type	Year(s) Data Gathered
"Atmospheric Emissions from Offshore Oil and Gas Development and Production", EPA 450/3-77-026, June 1977.	Yes	Oil and Gas	EF	Production	Offshore	Total Hydrocarbon (THC)	1975, 1985
"Atmospheric Hydrocarbon Emissions from Marine Vessel Transfer Operations," Publication 2514A, American Petroleum Institute, Washington, DC, Sept. 1981.	Yes	Yes	EF	Transportation	Marine Loading	THC	1977
"Global Emissions of Carbon Dioxide from Petroleum Sources," Prepared by Radian for API, July 1991.	Worldwide	Yes	Both	Combination	Various	CO <sub>2</sub>	1987-1990
"Worldwide Refining," Oil and Gas Journal, Dec. 21, 1992, p 84.	Yes	Yes	AF	Combination	Production and Refineries	None	1993
Radian Corporation. "Assessment of Atmospheric Emissions from Petroleum Refining: "Volumes I - IV" Prepared for U.S. Environmental Protection Agency. Research Triangle Park, NC. July 1980.	Yes	Yes	Some of both	Refinery	Various	Non-methane	1975-1978
Radian, Tier 2 Report for the GR/VEPA Methane Emissions Project, June 1995.	Yes	Natural Gas Industry	Both (AFs for Natural Gas)	Production	All production equip. except tanks	Methane	Base year 1992 (1991-1995)
Wetherold, R.G., G.E. Harris, F.D. Skinner, and L.P. Provost (Radian Corporation). "A Model for Evaluation of Refinery and Synfuels VOC Emission Data: Volumes 1 and 2. Research Triangle Park, NC.	Yes	Yes	EF, Default AFs	Refinery	Fugitive Components	Volatile Organic Carbon (VOC)	1985
"Development of Fugitive Emission Factors and Emission Profiles for Petroleum Marketing Terminals," Volume I and II, API, Washington DC, May 1993.	Yes	Yes	EF	Transportation	Fugitives	THC	?
"Global Emissions of Methane From Petroleum Sources," Prepared by Radian for API, February 1992.	Worldwide	Yes	Both	Combination	Various	Methane	1987-1990
"Offshore Oil and Gas Extraction - An Environmental Review," Battelle Columbus Labs, Prepared for Industrial Environmental Research Lab, July 1977.	Yes (Mainland and Alaska)	Oil and Gas	EF	Production	Exploration and Drilling	Methane	1965-1975

(Continued)

TABLE A-4a. SUMMARY OF REPORT DATABASE  
(Continued)

Report Title	U.S. Specific?	Petroleum Industry Based?	EF and/or AF Estimate	Industry Segment	Emission Source	Emission Type	Year(s) Data Gathered
Petroleum Supply Annual 1993, Volumes 1 and 2, Energy Information Administration, US DOE, Washington DC, June 1994.	Yes	Yes	AF	Combination	Supply and disposition data	NA	1993 and earlier
Picard, D.J., B.D. Ross, D.W.H. Koon. "A Detailed Inventory of CH4 and VOC Emissions From Upstream Oil And Gas Operations in Alberta." Canadian Petroleum Association, Calgary, Alberta, 1992.	Canadian Data	Oil and Gas	EF	Production	Various	Methane, VOC	1989
Radian Corporation. "Study of Refinery Fugitive Emissions from Equipment Leaks," API Health and Environmental Sciences Dept. and Western States Petroleum Assoc., Volumes 1 and 2, April 1994.	Yes	Yes	EF	Refinery	Fugitives	THC	1993
Rosebrook, D.D., R.G. Wetherold, and L.P. Provost. "The Development of Fugitive Emission Factors for the Petroleum Refining Industry", Presented at the 72nd Annual Meeting of the Air Pollution Control Association, June 1979.	Yes	Yes	EF	Refinery	Fugitives	Non-methane HC	1979
Tilkcioglu, B.H., "Annual Methane Emission Estimate of the Natural Gas Systems in the United States, Phase 2," Pipeline Systems Inc., Sept. 1990.	Yes	Some Oil Fields	Site ER	Production		Methane	1989
"Assessment of VOC Emissions from Well Vents Associated With Thermally Enhanced Oil Recovery", EPA 909/9-81-003, Sept. 1981.	Yes	Yes	EF	Production	Well vents	Methane, VOC	1978-1980
"Compilation of Air Pollutant Emission Factors (AP-42)," US EPA.	Yes	Yes	EFs	Combination	Various	TOC, THC	Most recent version
"Emissions of Greenhouse Gases in the United States 1987-1994," Energy Information Administration, November 1995.	Yes	Oil and Gas	EF (ER)	Combination	Not Specific	Methane	1987-1992
"Emissions of Producing Oil and Gas Wells", EPA 908/4-77-006, November 1977.	Yes, Colorado	Oil and Gas	EF	Production	Wells	THC	1976
"Fugitive Methane Emissions from Oil and Gas Production and Processing Facilities. Emission Factors Based on the 1980 API-Rockwell Study." Prepared for U.S. EPA, Prepared by STAR Environmental, April 1992.	Yes	Yes	EF discussed, no numbers.	Production	Fugitives	THC, non-methane HC	1980's

(Continued)

TABLE A-4a. SUMMARY OF REPORT DATABASE  
(Continued)

Report Title	U.S. Specific?	Petroleum Industry Based?	EF and/or AF Estimate	Industry Segment	Emission Source	Emission Type	Year(s) Data Gathered
"Oilfield Emissions of Volatile Organic Compounds", EPA-450/2-89-007, April 1989.	Yes	Yes	EF?	Production	Wellhead & tanks	Non-methane HC	1984-1985
C.E. Burklin, and R.L. Honeramp, "Revision of Evaporative Hydrocarbon Emission Factors," EPA-450/3-76-039, U.S. Environmental Protection Agency, Research Triangle Park, NC, August 1976.	Yes	Yes	EF	Combination		Hydrocarbon (HC)	1976
C.E. Burklin, et al., "Oil and Gas Field Emission Survey, USEPA, Contract No. 68-D1-0031, April 1992.	Yes	Yes	Both	Combination		Total Organic Gas	Not clear
DeLuchi, M.A., "Emissions from the Production, Storage, and Transport of Crude Oil and Gasoline," Journal of Air and Waste Management Association, Nov. 1993, pp. 1486-1495.	Yes	Yes	EF	Combination		VOC	2000
DuBose, D.A., J.I. Steinmetz, and G.E. Harris, "Frequency of Leak Occurrence and Emission Factors for Natural Gas Liquid Plants," Prepared for EPA, July 1982.	Yes	No, gas plants	EF	Production	Fugitives	VOC, non-methane/non-ethane	?
Houghton, J.T., G.J. Jenkins, and J.J. Ephraums. 1990. "Climate Change: The IPCC Scientific Assessment. Report prepared for IPCC by Working Group I," Intergovernmental Panel on Climate Change, Press Syndicate, University of Cambridge.	Global	All sources	ER	Production	Overall production ER	Methane and other GHGs	1988
M.G. Klett and J.B. Galeski, "Flare Systems Study," EPA-600/2-76-079, U.S. Environmental Protection Agency, Research Triangle Park, NC, March 1976.	Yes	Yes	EF	Combination	Flares in production and refining	THC	1958, 1973
N.F. Suprenant, et al., "Emissions Assessment of Conventional Stationary Combustion Systems, Volume V: Industrial Combustion Sources," EPA Contract No. 68-02-2197, GCA Corporation, Bedford, MA, October 1980.	Yes	Yes	EF	Refinery	Combustion Sources	THC	1978
"An Assessment of the Contribution of Gas to the Global Emissions of Carbon Dioxide Final Report (February-December 1983)", GRI, June 1984.	US and worldwide	Natural Gas and Oil	EF for Carbon	Production		Carbon	1984
"Anthropogenic Methane Emissions in the United States: Estimates for 1990," Report to Congress, EPA 430-R-93-003, April 1993.	Yes	Some data	Some of both	Combination		Methane	Base year 1990

(Continued)



TABLE A-4a. SUMMARY OF REPORT DATABASE  
(Continued)

Report Title	U.S. Specific?	Petroleum Industry Based?	EF and/or AF Estimate	Industry Segment	Emission Source	Emission Type	Year(s) Data Gathered
"Evaporation Loss from Fixed-Roof Tanks", API Bulletin 2518, June 1962, Reaffirmed August, 1987.	Yes	Yes	EF	Refinery	Tanks	Loss reported in barrels	1961
"Hydrocarbon Emissions from Refineries," API Publication No. 928, American Petroleum Institute, Washington, DC, July 1973.	Yes	Yes	EF	Refinery		HC	1973
"Independent Quality Assurance of Refinery Fugitives Testing by Western States Petroleum Association," EPA Office of Air Quality Planning and Standards, September 1993.	Yes	Yes	EF	Refinery	Refining Equipment Fugitives	Non-methane Organic Carbon, Air Toxics, THC	1992-1993
"Methane Emissions from the Oil and Gas Production Industries," Ruhrgas A.G., July 1989.	Worldwide	Oil and Gas	EF and AF	Combination	Well testing, emergencies in Prod. and Refining	Methane	1987
"Options for Reducing Methane Emissions Internationally Volume I: Technological Options for Reducing Methane Emissions," Report to Congress, EPA 430-R-93-006, July 1993.	Worldwide	Oil and Gas	Some of both	Production	Fugitives, pneumatics, compressors	Methane	1991
Basic Petroleum Data Book, Petroleum Industry Statistics Vol. VII, No 3, API, Sept. 1987.	Yes	Yes	Some AFs	Combination		None	1947-1986
C.E. Burklin, et al., "Revision of Emission Factors for Petroleum Refining," EPA-450/3-77-030, U.S. Environmental Protection Agency, Research Triangle Park, NC, October 1977.	Yes	Yes	EF	Refinery		THC	1972-1977
Estimating Air Toxics Emissions From Coal and Oil Combustion Sources, EPA-450/2-89-001, U.S. Environmental Protection Agency, Research Triangle Park, NC, April 1989.	Yes	Oil burned by users	EF		Boilers	Air Toxics, trace metals	1986
Kantor, R.H., "Trace Pollutants from Petroleum and Natural Gas Processing," Prepared for EPA by M.W. Kellogg Co., June 1974.	Yes	Oil and Gas	Some AFs	Production		None	1972
Lemlin, J.S., I. Graham-Bryce, "The Petroleum Industry's Response to Climate Change: The Role of the IPIECA Global Climate Change Working Group," UNEP Industry and Environment, Jan-Mar. 1994, pp 27-30.	Global	Yes	Neither			None	

(Continued)

TABLE A-4a. SUMMARY OF REPORT DATABASE  
(Continued)

Report Title	U.S. Specific?	Petroleum Industry Based?	EF and/or AF Estimate	Industry Segment	Emission Source	Emission Type	Year(s) Data Gathered
Lipton, Sydney, "Fugitive Emissions," Chemical Engineering Progress, Vol. 85, No. 6, pp. 42-47, June 1989.	Yes	Chemical and Refining	EF	Refinery	Refining Fugitives	THC?	
Mussig, S., et al., "Possibilities for Reduction of Emissions - in Particular the Greenhouse Gases CO <sub>2</sub> and CH <sub>4</sub> - in the Oil and Gas Industry," Presented at the European Petroleum Conference, Nov. 1992.	No	Yes	EF for Germany	Production	Not specific	Methane	1989
R.F. Boland, et al., Screening Study for Miscellaneous Sources of Hydrocarbon Emissions in Petroleum Refineries, USEPA, Dec. 1976.	Yes	Yes	EF from AP-42	Refinery	Fugitives	HC	1985
Rosenberg, E.S., "Impact of the "HON" Rule on the Petrochemicals and Refining (Industries)," Presented at the 1993 NPRA Annual Meeting, March, 1993.	?	Yes	Neither	Refinery		None	1993
Taback, H.J., G. Lauer, L.K. Gilmer, and K. Ritter, "Strategies for Improving HAP Emission Factors and Profiles for the Petroleum Industry," Presented at the 85th Annual Meeting and Exhibition of the Air and Waste Management Association, June 1992.	Yes	Yes	EFs for HAPs	Refinery	Burners	HAPs	1992
Taback, H.J., and K. Ritter, "1994 Fugitive Emissions Estimating Data for Petroleum Industry Equipment Leaks," Presented at the Air and Waste Management Association and California Air Resources Board 5th Annual West Coast Regional Specialty Conference, Nov. 1994.	Yes	Yes, all segments	EF	Combination	Valves, flanges, connections	THC?	1994
U.S. EPA, "Development Document for Proposed Effluent Limitations Guidelines and Standard for the Petroleum Refining Point Source Category (Proposed)," John Lum - Project Officer, Effluent Guidelines Division, U.S. EPA, Washington, DC, 20460, December, 1979.	Yes	Yes	Neither				1979
US Crude Oil, Natural Gas and Natural Gas Liquid Reserves, 1993 Annual Report, Energy Information Administration, US DOE, Washington DC, October 1994.	Yes	Yes	Neither				

(Continued)

TABLE A-4a. SUMMARY OF REPORT DATABASE  
(Continued)

Report Title	U.S. Specific?	Petroleum Industry Based?	EF and/or AF Estimate	Industry Segment	Emission Source	Emission Type	Year(s) Data Gathered
Webb, M. and P. Martino, "Fugitive Hydrocarbon Emissions from Petroleum Production Operations," Presented at the 85th Annual Meeting and Exhibition of the Air and Waste Management Association, June 1992.	Yes	Yes	EF	Production	Fugitive Components	Methane, HC	1980
U.S. Environmental Protection Agency. <i>Inventory of U.S. Greenhouse Gas Emissions and Sinks: 1990-1994</i> . EPA-230-R-96-006 (NTIS PB 96-175997). U.S. Environmental Protection Agency, Office of Policy, Planning and Evaluation, Washington DC, November 1995.	Yes	Oil and Gas	EF	Combination	Model Facilities	CO <sub>2</sub> and Methane	1990-1993

TABLE A-4b. SUMMARY OF REPORT DATABASE

Report Title	Methodology	Modifications	Usefulness	Accuracy?	Comments
"Atmospheric Emissions from Offshore Oil and Gas Development and Production", EPA 450/3-77-026, June 1977.	Measurements & Guesses	THC is 83.6% CH4 by volume, convert to CH4	Excellent	Unknown	Great source for offshore emission factors.
"Atmospheric Hydrocarbon Emissions from Marine Vessel Transfer Operations," Publication 2514A, American Petroleum Institute, Washington, DC, Sept. 1981.	Measurements	Need methane composition.	Excellent	Confidence Intervals and STD provided.	Report provided emission factors for gasoline and crude oil for a general case or based on specific information (type of vessel, prior cargo, compartment treatment, volume). No statistically significant correlation could be developed for gasoline loading.
"Global Emissions of Carbon Dioxide from Petroleum Sources," Prepared by Radian for API, July 1991.	EPA & Industry Documents		Excellent	Compares well w/ other estimate sources	End uses (beyond the scope of this study) have the largest emissions. Emission factors given for individual refining processes based on bbl throughput. Data for exploration and production are very general.
"Worldwide Refining," Oil and Gas Journal, Dec. 21, 1992, p 84.	Industry reports/survey	AFs only	Excellent	Good, can be calculated for companies listed.	Lists production/well and # wells for production and capacity of various refining operations.
Radian Corporation. "Assessment of Atmospheric Emissions from Petroleum Refining: Volume 2, Appendix A" Prepared for U.S. Environmental Protection Agency. Research Triangle Park, NC. July 1980.	Measurements & AP-42	Might be able to scale the non-CH4.	Excellent	Good for data given.	Calculates non-CH4 EF based on refinery throughput. Main contributors are fugitives and heaters. Representative components counts for fugitives are provided for each unit.
Radian, Tier 2 Report for the GRU/EPA Methane Emissions Project, June 1995.	Measurements, Surveys		Excellent	90% Confidence Intervals	Assume CH4 emissions from gas industry equipment are applicable to oil industry. Project is still in progress, so numbers may change slightly.
Wetherold, R.G., G.E. Harris, F.D. Skinner, and L.P. Provost (Radian Corporation). "A Model for Evaluation of Refinery and Synfuels VOC Emission Data: Volumes 1 and 2," Research Triangle Park, NC.	Literature Search	Need methane composition.	Excellent	Not Available	Great source for emissions factors. Need to relate unit operations presented here to unit capacities reported in <i>Oil and Gas Journal</i> .
"Development of Fugitive Emission Factors and Emission Profiles for Petroleum Marketing Terminals," Volume I, API, Washington DC, May 1993.	Measured	Need methane composition.	Good	95% confidence intervals for most	
"Global Emissions of Methane From Petroleum Sources," Prepared by Radian for API, February 1992.	EPA & Industry Documents		Good	Low	Primarily overall emission estimates for each industry segment. Production excludes venting and flaring, and couldn't separate oil from gas.

(Continued)

TABLE A-4b. SUMMARY OF REPORT DATABASE  
(Continued)

Report Title	Methodology	Modifications	Usefulness	Accuracy?	Comments
"Offshore Oil and Gas Extraction - An Environmental Review," Battelle Columbus Labs, Prepared for Industrial Environmental Research Lab, July 1977.	Estimates	72.4% CH <sub>4</sub> in natural gas	Good	Poor	Relies on AP42 emission factors: 0.1#/barrel (fires), 38#/barrel evap. Oil production is generally thought to have a low potential for contribution to air pollution. Control of evaporation from tanks is required.
Petroleum Supply Annual 1993, Volumes 1 and 2, Energy Information Administration, US DOE, Washington DC, June 1994.	Industry reports	NA	Good	Good	Data reported on a monthly basis by all but 4 states.
Picard, D.J., B.D. Ross, D.W.H. Koon. "A Detailed Inventory of CH <sub>4</sub> and VOC Emissions From Upstream Oil And Gas Operations in Alberta." Canadian Petroleum Association, Calgary, Alberta, 1992.	Measurements	Convert THC losses to CH <sub>4</sub> .	Good	95% confidence intervals are provided.	Some methane specific EFs, others reported as VOC. Raw data provided with methane and carbon dioxide speciation.
Radian Corporation. "Study of Refinery Fugitive Emissions from Equipment Leaks," API Health and Environmental Sciences Dept. and Western States Petroleum Assoc., Volumes 1 and 2, April 1994.	Measurements from 3 sites	CH <sub>4</sub> composition provided in raw data	Good	95% Confidence Intervals	Reviews EFAs 1993 protocol equations for refinery fugitive emissions. The five facilities measured had O&M programs to reduce the number of leaking components.
Rosebrook, D.D., R.G. Wetherold, and L.P. Provost, "The Development of Fugitive Emission Factors for the Petroleum Refining Industry", Presented at the 72nd Annual Meeting of the Air Pollution Control Association, June 1979.	Samples and study	Need methane composition.	Good	95% confidence interval	Great source for nonmethane VOC EFs.
Tilkiciglu, B.H., "Annual Methane Emission Estimate of the Natural Gas Systems in the United States, Phase 2," Pipeline Systems Inc., Sept, 1990.	Extrapolated based on 3 sites		Good	Poor, could provide site specific data for two sites.	Data reported from two sites of interest: oil field w/ gas utilization for sale, and gas/oil field. Project collected data from an oil field w/ no gas production but data were not reported.
"Assessment of VOC Emissions from Well Vents Associated With Thermally Enhanced Oil Recovery", EPA 909/9-81-003, Sept. 1981.	Measurements from 58 sites	Data provided to calculate EF	Potential	Can be calculated from data	Cyclic THEOR wellhead casing vents.
"Compilation of Air Pollutant Emission Factors (AP-42)," US EPA.	Various	Need methane composition.	Potential	Data quality estimates provided.	
"Emissions of Greenhouse Gases in the United States 1987-1994," Energy Information Administration, November 1995.	Other studies		Potential	Precision of CH <sub>4</sub> estimates 30-50%.	Some of the data presented are taken from Radian's API study on global emissions. It is likely that the actual CH <sub>4</sub> emissions are higher than shown.

(Continued)

TABLE A-4b. SUMMARY OF REPORT DATABASE  
(Continued)

Report Title	Methodology	Modifications	Usefulness	Accuracy?	Comments
"Emissions of Producing Oil and Gas Wells", EPA 908/4-77-006, November 1977.	Sampled	Need methane composition.	Potential	Diurnal variation mean 95	Good source for well emissions, but old data.
"Fugitive Methane Emissions from Oil and Gas Production and Processing Facilities. Emission Factors Based on the 1980 API-Rockwell Study," Prepared for USEPA, Prepared by STAR Environmental, April 1992.	Sampling	Can be calculated based on non-CH4 HC	Potential		Important parameters affecting EFs: % of components that leak and distribution of leaks into various size categories. Old emission factors may over predict current operations based on recent industry changes. Reports says that fugitive emissions factors were developed for production, but none are reported.
"Oilfield Emissions of Volatile Organic Compounds", EPA-450/2-89-007, April 1989.	Measurements	Need THC or methane composition.	Potential	Could be calculated based on raw data.	For the gas-drive well, gas was vented to the atmosphere. The well produces a maximum of 10,000 cfd. Speciation of non-methane gas components is provided for sources tested. However, compositions are scaled to 100% without CH4.
C.E. Burklin, and R.L. Honercamp, "Revision of Evaporative Hydrocarbon Emission Factors," EPA-450/3-76-039, U.S. Environmental Protection Agency, Research Triangle Park, NC, August 1976.	Measured and Guessed	Need methane composition.	Potential	Poor	Updates AP-42 emission equations.
C.E. Burklin, et al., Oil and Gas Field Emission Survey, USEPA, Contract No. 68-D1-0031, April 1992.	Paper study	Need methane and CO2 composition.	Potential	?	Referenced other resources.
DeLuchi, M.A., "Emissions from the Production, Storage, and Transport of Crude Oil and Gasoline," Journal of Air and Waste Management Association, Nov. 1993, pp. 1486-1495.		Need methane composition related to VOC	Potential	Unknown	Estimate VOC emissions for 2000. EFs in terms of grams VOC/gallon of fuel consumed.
DuBose, D.A., J.I. Steinmetz, and G.E. Harris, "Frequency of Leak Occurrence and Emission Factors for Natural Gas Liquid Plants," Prepared for EPA, July 1982.	Measurements	Need methane composition.	Potential	95% confidence interval.	Report summarizes measured fugitive emissions from gas plants at crude oil petroleum and natural gas onshore production facilities. Perhaps components common to both oil and gas can be used for oil study.
Houghton, J.T., G.J. Jenkins, and J.J. Ephraums. 1990. "Climate Change: The IPCC Scientific Assessment. Report prepared for IPCC by Working Group I," Intergovernmental Panel on Climate Change, Press Syndicate, University of Cambridge.	Not clear	Convert Global ER to US.	Potential	Unknown	Reported production emission range of 25-50 Tg/yr for gas drilling, venting, and transmission.

(Continued)

TABLE A-4b. SUMMARY OF REPORT DATABASE  
(Continued)

Report Title	Methodology	Modifications	Usefulness	Accuracy?	Comments
M.G. Klett and J.B. Galeski, "Flare Systems Study," EPA-600/2-76-079, U.S. Environmental Protection Agency, Research Triangle Park, NC, March 1976.	Estimates, min. field testing	Need methane composition	Potential	Poor, AP-42 rank C	Total flare emissions annually <1% average yearly plant emissions. Very little experimental data on flare emissions exist due to sampling difficulty. Compare with GRI/EPA flare summary table.
N.F. Suprenant, et al., "Emissions Assessment of Conventional Stationary Combustion Systems, Volume V: Industrial Combustion Sources," EPA Contract No. 68-02-2197, GCA Corporation, Bedford, MA, October 1980.	Not reported.	Need methane composition.	Potential	Not reported.	Can boiler emissions be related to other combustion sources (e.g. heater/treater)?
"An Assessment of the Contribution of Gas to the Global Emissions of Carbon Dioxide Final Report (February-December 1983)", GRI, June 1984.	Reported emissions as kg C	Can carbon emissions be related to CH4?	Poor	Poor	Report assesses the contribution from the future consumption of fuel gas to global emissions of CO2. Emissions are given for carbon based on energy usage.
"Anthropogenic Methane Emissions in the United States: Estimates for 1990," Report to Congress, EPA 430-R-93-003, April 1993.	Other sources		Poor	Poor, mostly estimates	Total methane emissions from petroleum production and refining were estimated to range from 0.1 to 0.6 Tgyr in the U.S. The majority of this is associated with venting during oil production.
"Evaporation Loss from Fixed-Roof Tanks", API Bulletin 2518, June 1962, Reaffirmed August, 1987.	Survey of available data		Poor	+/- 10% for calculations within the range of data.	This bulletin is the result of a study of available test data on evaporation losses from cone-roof tanks. Test data did not include crude containing significant amounts of methane or ethane; therefore, the equations may not be applicable to production lease tanks.
"Hydrocarbon Emissions from Refineries," API Publication No. 928, American Petroleum Institute, Washington, DC, July 1973.	Measurements & estimates	Need methane composition.	Poor		Report estimates the major sources of HC emissions from refineries. Costs of methods and facilities for reducing HC losses were developed. Extremely difficult to follow emission estimates.
"Independent Quality Assurance of Refinery Fugitives Testing by Western States Petroleum Association," EPA Office of Air Quality Planning and Standards, September 1993.	Measurement		Poor	Could be calculated	This report is an audit of the data presented in "Study of Refinery Emissions from Equipment Leaks." Report mainly discussed the errors associated with the data. No new data are presented.
"Methane Emissions from the Oil and Gas Production Industries," Ruhrgas A.G., July 1989.	Measurements from 18 plants	Need to scale from worldwide data	Poor	?	Oil industry ~ 6x gas industry methane emissions. 14 Bcf CH4 enters the atmosphere each year.
"Options for Reducing Methane Emissions Internationally Volume I: Technological Options for Reducing Methane Emissions," Report to Congress, EPA 430-R-93-006, July 1993.	Other sources, some measured		Poor	No estimates	Some EFs are given for illustration purposes. Deals primarily with options to reduce CH4 emissions.

(Continued)

TABLE A-4b. SUMMARY OF REPORT DATABASE  
(Continued)

Report Title	Methodology	Modifications	Usefulness	Accuracy?	Comments
Basic Petroleum Data Book, Petroleum Industry Statistics Vol. VII, No 3, API, Sept. 1987.	No emissions data.		Poor		Some AFs, but from 1987. Economic data primarily.
C.E. Burklin, et al., "Revision of Emission Factors for Petroleum Refining," EPA-450/3-77-030, U.S. Environmental Protection Agency, Research Triangle Park, NC, October 1977.	Literature Search	Reported that overall emissions were 0.3 wt% CH4	Poor	Poor due to age of data and unknown stream comp.	Data are old. Waste stream emissions reported as HC, no speciation.
Estimating Air Toxics Emissions From Coal and Oil Combustion Sources, EPA-450/2-89-001, U.S. Environmental Protection Agency, Research Triangle Park, NC, April 1989.	Literature search, interviews		Poor	Low	Not related to scope of this project. Boiler data only.
Kantor, R.H., "Trace Pollutants from Petroleum and Natural Gas Processing," Prepared for EPA by M.W. Kellogg Co., June 1974.	?		Poor	Poor	Identifies continuous vs. intermittent emitters. Some activity factors provided.
Lemlin, J.S., I. Graham-Bryce, "The Petroleum Industry's Response to Climate Change: The Role of the IPIECA Global Climate Change Working Group," UNEP Industry and Environment, Jan-Mar. 1994, pp 27-30.			Poor		Discusses IPIECA's role and approach in understanding the global climate change issue. Does not report EFs or AFs.
Lipton, Sydney, "Fugitive Emissions," Chemical Engineering Progress, Vol. 85, No. 6, pp. 42-47, June 1989.	AP-42	Need methane composition.	Poor	?	AP-42 fugitive emissions.
Mussig, S., et al., "Possibilities for Reduction of Emissions - in Particular the Greenhouse Gases CO2 and CH4 - in the Oil and Gas Industry," Presented at the European Petroleum Conference, Nov. 1992.	Data from another report.	Assume Germany emissions are same for US	Poor	Unknown	Article discusses methods to reduce CO2 and CH4 emissions.
R.F. Boland, et al., Screening Study for Miscellaneous Sources of Hydrocarbon Emissions in Petroleum Refineries, USEPA, Dec. 1976.	AP-42	Need methane composition.	Poor	AP-42 basis	AP-42 factors were refined based on the extent of BACT control estimated from NSPS regs. Controlled and uncontrolled EFs were weighted to arrive at an average EF, which could be ratioed by throughput. Good descriptions of various refining operations.

(Continued)



TABLE A-4b. SUMMARY OF REPORT DATABASE  
(Continued)

Report Title	Methodology	Modifications	Usefulness	Accuracy?	Comments
Rosenberg, E.S., "Impact of the "HON" Rule on the Petrochemicals and Refining (Industries)," Presented at the 1993 NPRA Annual Meeting, March, 1993.			Poor		No CH4 EFs or AFs. Overview of the HON, its interaction w/the rules for modification of the sources of toxic air pollutants, controls of VOCs, and EPA's operating permit rule.
Taback, H.J., G. Lauer, L.K. Gilmer, and K. Ritter, "Strategies for Improving HAP Emission Factors and Profiles for the Petroleum Industry," Presented at the 85th Annual Meeting and Exhibition of the Air and Waste Management Association, June 1992.	Source testing	Need methane composition.	Poor		No CH4 emissions. Lists research projects underway in the areas of component leaks, process vents, transfer operations, wastewater and others.
Taback, H.J., and K. Ritter, "1994 Fugitive Emissions Estimating Data for Petroleum Industry Equipment Leaks," Presented at the Air and Waste Management Association and California Air Resources Board 5th Annual West Coast Regional Specialty Conference, Nov. 1994.	Measurements	Need methane composition.	Poor	Not given w/ data.	Symposium paper.
U.S. EPA, "Development Document for Proposed Effluent Limitations Guidelines and Standard for the Petroleum Refining Point Source Category (Proposed)," John Lum - Project Officer, Effluent Guidelines Division, U.S. EPA, Washington, DC, 20460, December, 1979.			Poor		Summarizes EPA's review of petroleum industry with respect to discharge of toxics in US waters.
US Crude Oil, Natural Gas and Natural Gas Liquid Reserves, 1993 Annual Report, Energy Information Administration, US DOE, Washington DC, October 1994.	EIA surveys		Poor	Good	Presents data only on reserves.
Webb, M. and P. Martino, "Fugitive Hydrocarbon Emissions from Petroleum Production Operations," Presented at the 85th Annual Meeting and Exhibition of the Air and Waste Management Association, June 1992.	Published and field study		Poor	Not available	Analysis of field data for fugitive equipment leaks. Indicates that existing EFs over predict HC emissions from petroleum production operations with directed maintenance programs. No data given.
U.S. Environmental Protection Agency. <i>Inventory of U.S. Greenhouse Gas Emissions and Sinks: 1990-1994</i> . EPA-230-R-96-006 (NTIS PB 96-175997). U.S. Environmental Protection Agency, Office of Policy, Planning and Evaluation, Washington DC, November 1995.	Emission Inventory & Models		Potential	Poor due to lack of supporting data for oil	Combines oil and gas production. Report states high level of uncertainty in the data.

TABLE A-5a. PRODUCTION EMISSION DATABASE

Report Title	Overall Site Emission Estimate	Tanks	Flares - Well Completion	Well Blowout	Well Workovers
"Anthropogenic Methane Emissions in the United States: Estimates for 1990." Report to Congress, EPA 430-R-93-003, April 1993.	Methane emission estimates kg/well/yr			Wells in general: 72 kg/well/yr	
"Assessment of VOC Emissions from Well Vents Associated With Thermally Enhanced Oil Recovery", EPA 909/9-81-003, Sept. 1981.	Well casing emissions 64.9 lb CH4/d (+/- 29%)				
"Atmospheric Emissions from Offshore Oil and Gas Development and Production", EPA 450/3-77-026, June 1977.	HC emissions	367 M g HC/10 <sup>6</sup> bbl	10 kg/10 <sup>6</sup> cf gas flared	20 M g /well/day	
"Global Emissions of Methane From Petroleum Sources", Prepared by Radian for API, February 1992.	U.S. 12,074 ton CH4/yr excluding Venting & Flaring		98 Bscf gas flared in US		
"Methane Emissions from the Oil and Gas Production Industries," Ruhrgas A.G., July 1989.	10.5 bcm CH4/yr worldwide, 1.7 bcm/yr N. America		Lasts 5-10 days, 95% test gas flared	Some estimates provided	
"Offshore Oil and Gas Extraction - An Environmental Review," Battelle Columbus Labs, Prepared for Industrial Environmental Research Lab, July 1977.		Some estimates provided	8 lb CH4/MMcf (AP-42) (per well?)	Combustion 0.1, Evaporation 38 (lb HC/bbl)	
DuBoise, D.A., J.I. Steinmetz, and G.E. Harris, "Frequency of Leak Occurrence and Emission Factors for Natural Gas Liquid Plants," Prepared for EPA, July 1982.	Reported THC and non-methane/non-ethane as kg/day/source				
Petroleum Supply Annual 1993, Volumes 1 and 2, Energy Information Administration, US DOE, Washington DC, June 1994.	Production for 1988-1993 in comments		1993 # completions 7994 (6%<1992)		
Pitard, D.J., B.D. Ross, D.W.H. Koon. "A Detailed Inventory of CH4 and VOC Emissions From Upstream Oil And Gas Operations in Alberta." Canadian Petroleum Association, Calgary, Alberta, 1992.	90% Confidence Interval calculated	7.94 m <sup>3</sup> gas/hr (+/- 88%)			
Radian, Tier 2 Report for the GRI/EPA Methane Emissions Project, June 1995.	Emissions in scfd/device				
Tilkiciglu, B.H., "Annual Methane Emission Estimate of the Natural Gas Systems in the United States, Phase 2," Pipeline Systems Inc., Sept. 1990.	Data from 2 Facilities: #1 Oil, #2 Oil/gas				#1 & #2 2 cf CH4/hr

TABLE A-5b. PRODUCTION EMISSION DATABASE

Report Title	Heaters	Pneumatic Devices	Chemical Injection Pumps	Compressor Starts	Compressor Blowdowns
"Atmospheric Emissions from Offshore Oil and Gas Development and Production", EPA 450/3-77-026, June 1977.	0.05 M g HC/10 <sup>6</sup> bbl				
C.E. Burklin, et al., Oil and Gas Field Emission Survey, USEPA, Contract No. 68-D1-0031, April 1992.	3 lb CH <sub>4</sub> /10 <sup>6</sup> ft <sup>3</sup>		Fugitives 0.004 lb/day-well		
Picard, D.J., B.D. Ross, D.W.H. Koon. "A Detailed Inventory of CH <sub>4</sub> and VOC Emissions From Upstream Oil And Gas Operations in Alberta." Canadian Petroleum Association, Calgary, Alberta, 1992.		0.1996 m <sup>3</sup> gas/hr (+/- 52%)	0.39446 m <sup>3</sup> gas/hr (+/-30%)		
Radian, Tier 2 Report for the GRI/EPA Methane Emissions Project, June 1995.		493 (+/- 55%)	439 (+/- 91%)	14.3 (+/- 74%)	12 (+/- 52%)
Tilkcioglu, B.H., "Annual Methane Emission Estimate of the Natural Gas Systems in the United States, Phase 2." Pipeline Systems Inc., Sept. 1990.		#1 946, #2 25,871 #CH <sub>4</sub> /y			

TABLE A-5c. PRODUCTION EMISSION DATABASE

Report Title	Overall Site	Other Fugitives	Connections & Flanges	Open Ended Lines
"Emissions of Greenhouse Gases in the United States 1987-1994," Energy Information Administration, November 1995.	1992, 5.97 trillion ft <sup>3</sup> natural gas withdrawn from oil wells	Vented = 640,000 metric tons CH <sub>4</sub> /yr		
"Emissions of Producing Oil and Gas Wells," EPA 908/4-77-006, November 1977.	16.5 lb THC/day (Rod pump well), 0.008 lb/d (elec. subm.)			
"Options for Reducing Methane Emissions Internationally Volume 1: Technological Options for Reducing Methane Emissions," Report to Congress, EPA 430-R-93-006, July 1993.	Reported as kg CH <sub>4</sub> /day, number of components, plant emissions		0.021, 3000, 62	
C.E. Burklin, and R.L. Honercamp, "Revision of Evaporative Hydrocarbon Emission Factors," EPA-450/3-76-039, U.S. Environmental Protection Agency, Research Triangle Park, NC, August 1976.	346,000 ton HC/yr (oil), 544,000 ton HC/yr (gas)			
C.E. Burklin, et al., Oil and Gas Field Emission Survey, USEPA, Contract No. 68-D1-0031, April 1992.			Some estimates provided	
DuBose, D.A., J.I. Steinmetz, and G.E. Harris, "Frequency of Leak Occurrence and Emission Factors for Natural Gas Liquid Plants," Prepared for EPA, July 1982.	Reported as 1) THC 2) non-methane/non-ethane		0.026 0.011	0.53 0.34
Picard, D.J., B.D. Ross, D.W.H. Koon. "A Detailed Inventory of CH <sub>4</sub> and VOC Emissions From Upstream Oil And Gas Operations in Alberta." Canadian Petroleum Association, Calgary, Alberta, 1992.			Gas/Vapor 0.0079, Light Liquid 0.00019	

TABLE A-5d. PRODUCTION EMISSION DATABASE

Report Title	Fugitives - Overall	Fugitives - Separators	Fugitives - Heaters	Fugitives - Compressors	Fugitives - Meter/Sales	Fugitives - Pipeline	Fugitives - Platforms
"Anthropogenic Methane Emissions in the United States: Estimates for 1990," Report to Congress, EPA 430-R-93-003, April 1993.	76.7 kg/well/yr						
"Global Emissions of Methane From Petroleum Sources", Prepared by Radian for API, February 1992.	Wells - 0.1735 t/y per well						
"Methane Emissions from the Oil and Gas Production Industries," Ruhrgas A.G., July 1989.	Wells 5 ton/yr per oil well						
C.E. Burklin, et al., Oil and Gas Field Emission Survey, USEPA, Contract No. 68-D1-0031, April 1992.				0.07 lb ROG/day per well			
Picard, D.J., B.D. Ross, D.W.H. Koon. "A Detailed Inventory of CH4 and VOC Emissions From Upstream Oil And Gas Operations in Alberta." Canadian Petroleum Association, Calgary, Alberta, 1992.	19.151 kt THC, 10.533 kt VOC						
Radian, Tier 2 Report for the GRI/EPA Methane Emissions Project, June 1995.		122 (+/- 33%)	57.7 (+/- 40%)	Small 267.8, Large 16360	52.9	57.8 (+/- 97%)	Gulf 2914, Other US 1178

TABLE A-5e. PRODUCTION EMISSION DATABASE

Report Title	Vessel Blowdown	Other Engines	PRV	ESD/EBD	Other
"Anthropogenic Methane Emissions in the United States: Estimates for 1990," Report to Congress, EPA 430-R-93-003, April 1993.					Maintenance 0.15 kg/well/yr
"Atmospheric Emissions from Offshore Oil and Gas Development and Production", EPA 450/3-77-026, June 1977.		Turbine 0.14 g/hp-hr, Gas Recip 4.86, Oil Recip 0.43			Pump seals 0.1 M g/10 <sup>6</sup> bbl
"Compilation of Air Pollutant Emission Factors (AP-42)," US EPA.		Turbine(g/kWhr):0.117(gas), 0.083(oil)TOC as CH4(D)			
"Emissions of Greenhouse Gases in the United States 1987-1994," Energy Information Administration, November 1995.					Oil wells - 0.072 metric tons CH4/well
"Global Emissions of Methane From Petroleum Sources", Prepared by Radian for API, February 1992.		1e-4 ton CH4/yr/well			
"Offshore Oil and Gas Extraction - An Environmental Review," Battelle Columbus Labs, Prepared for Industrial Environmental Research Lab, July 1977.		Diesel Eng.: 0.16 lb HC/hr or 37.5 lb HC/1000 gal			
C.E. Burklin, et al., Oil and Gas Field Emission Survey, USEPA, Contract No. 68-D1-0031, April 1992.		Diesel 0.07, Dual fuel 4.7 lb CH4/1000 hp-hr			Well heads 0.01 lb ROG/well day
Radian, Tier 2 Report for the GRI/EPA Methane Emissions Project, June 1995.	0.375 (+/- 67%)		0.337 ± 112%	704 ± 200%	Fugitive Comp. Station 8247
Tilkcioglu, B.H., "Annual Methane Emission Estimate of the Natural Gas Systems in the United States, Phase 2," Pipeline Systems Inc., Sept. 1990.					Upsets: #1 - 34776 # CH4/y

TABLE A-5f. PRODUCTION EMISSION DATABASE

Report Title	Pump Seals	Compressor Seals	Valves	Pressure Relief Valves	Other
"Emissions of Greenhouse Gases in the United States 1987-1994," Energy Information Administration, November 1995.					Wells = 0.04e6 metric tons CH <sub>4</sub> /yr (1987-1992)
"Emissions of Producing Oil and Gas Wells," EPA 908/4-77-006, November 1977.					THC is 47.6% methane from 5 measurements
"Options for Reducing Methane Emissions Internationally Volume 1: Technological Options for Reducing Methane Emissions," Report to Congress, EPA 430-R-93-006, July 1993.	5.12, 12, 30 (seals in general)		0.384, 750, 288	3.6, 12, 43	Compressor Exhaust: recip 500, turbine 6-12 kg CH <sub>4</sub> /MMcf fuel
C.E. Burklin, and R.L. Honercamp, "Revision of Evaporative Hydrocarbon Emission Factors," EPA-450/3-76-039, U.S. Environmental Protection Agency, Research Triangle Park, NC, August 1976.	8 lb HC/day per seal	4 lb HC/1000 bbl crude		2.4 lb HC/day-valve	Separators 8 lb/1000 bbl, Pumps 75 lb/1000 bbl
C.E. Burklin, et al., Oil and Gas Field Emission Survey, USEPA, Contract No. 68-D1-0031, April 1992.			Some estimates provided		
DuBose, D.A., J.I. Steinmetz, and G.E. Harris, "Frequency of Leak Occurrence and Emission Factors for Natural Gas Liquid Plants," Prepared for EPA, July 1982.	1.5 1.2	4.6 1.0	0.48 0.18	4.5 0.33	95% Conf. Int. provided.
Picard, D.J., B.D. Ross, D.W.H. Koon. "A Detailed Inventory of CH <sub>4</sub> and VOC Emissions From Upstream Oil And Gas Operations in Alberta." Canadian Petroleum Association, Calgary, Alberta, 1992.	0.02139 kg/hr/source THC	0.80488 kg/hr/source THC	GV 0.01417, LL 0.00121	0.12096 kg/hr/source, 0.0019 m <sup>3</sup> /hr	

TABLE A-6a. TRANSPORTATION EMISSION DATABASE

Report Title	Truck/Car Loading	Barge Loading	Marine Tanker Loading	Rail Car Loading
"Anthropogenic Methane Emissions in the United States: Estimates for 1990," Report to Congress, EPA 430-R-93-003, April 1993.			1 lb HC/1000 gal crude. HC contains 20% CH4	
"Atmospheric Hydrocarbon Emissions from Marine Vessel Transfer Operations," Publication 2514A, American Petroleum Institute, Washington, DC, Sept. 1981.		Average Factors given.	General EF 1.0 lb HC/1000 gal	
"Compilation of Air Pollutant Emission Factors (AP-42)," US EPA.	Calculation methods and average values given.	typical=3.4, unclean=3.9	1.8 typical	
"Emissions of Greenhouse Gases in the United States 1987-1994," Energy Information Administration, November 1995.			2.55e-4 short tons CH4/bbl	
"Global Emissions of Methane From Petroleum Sources", Prepared by Radian for API, February 1992.	12,400 tpy, 7.9e-6 ton CH4/bbl	3500 tpy, 2.55e-6 ton CH4/bbl		700 tpy, 7.9e-6 ton CH4/bbl
"Hydrocarbon Emissions from Refineries," API Publication No. 928, American Petroleum Institute, Washington, DC, July 1973.	Splash 700, Sub. 225 t HC/y	0.007 % load vol./psia true vp		
C.E. Burklin, and R.L. Honercomp, "Revision of Evaporative Hydrocarbon Emission Factors," EPA-450/3-76-039, U.S. Environmental Protection Agency, Research Triangle Park, NC, August 1976.	0.4-7 lb/1000 gal transferred	1.2-4 lb/1000 gal transferred		
C.E. Burklin, et al., Oil and Gas Field Emission Survey, U.S. EPA, Contract No. 68-D1-0031, April 1992.	2.8, 4.7 lb VOC/1000 gal			6.6, 4.7 lb VOC/1000 gal
DeLuca, M.A., "Emissions from the Production, Storage, and Transport of Crude Oil and Gasoline," Journal of Air and Waste Management Association, Nov. 1993, pp. 1486-1495.		0.024 (oil), 0.23 (gasoline)	Oil:0.027 (AK), 0.004 lower 48	
Wetherold, R.G., G.E. Harris, F.D. Skinner, and L.P. Provost (Radian Corporation). "A Model for Evaluation of Refinery and Synfuels VOC Emission Data: Volumes 1 and 2." Research Triangle Park, NC.	Values provided based on loading style, and petroleum product.	Values provided based on loading style, and petroleum product.	Values provided based on loading style, and petroleum product.	



TABLE A-6b. TRANSPORTATION EMISSION DATABASE

Report Title	Overall Site	Fugitives	Other
"Atmospheric Emissions from Offshore Oil and Gas Development and Production", EPA 450/3-77-026, June 1977.	AFs for transport from offshore platforms		14 Barge systems, 66 pipeline commingling systems
"Compilation of Air Pollutant Emission Factors (AP-42)", US EPA.	VOC EF as lb/1000 gal transferred		
"Emissions of Greenhouse Gases in the United States 1987-1994," Energy Information Administration, November 1995.	1992 - 83,000 metric ton CH4 from marine vessels	Pipeline fugitives. negligible, most crude transported by pipe	
"Global Emissions of Methane From Petroleum Sources", Prepared by Radian for API, February 1992.	US 16,703 ton CH4/yr		
C.E. Burklin, and R.L. Honercamp, "Revision of Evaporative Hydrocarbon Emission Factors," EPA-450/3-76-039, U.S. Environmental Protection Agency, Research Triangle Park, NC, August 1976.	538,000 ton HC/yr	0.15 lb HC/day per valve	
C.E. Burklin, et al., "Revision of Emission Factors for Petroleum Refining," EPA-450/3-77-030, U.S. Environmental Protection Agency, Research Triangle Park, NC, October 1977.			Heaters: 42 lb HC/1000 bbl, 0.003 lb/1000 ft <sup>3</sup>
C.E. Burklin, et. al., Oil and Gas Field Emission Survey, U.S. EPA, Contract No. 68-D1-0031, April 1992.	VOC emissions: 1) submerged loading 2) splash loading		
DeLuchi, M.A., "Emissions from the Production, Storage, and Transport of Crude Oil and Gasoline," Journal of Air and Waste Management Association, Nov. 1993, pp. 1486-1495.	Emissions reported as g VOC/gal fuel consumed by motorists	Field storage EF 0.056, bulk plant 0.27-0.55	Gasoline tanker loading 0.047, treating crude 0.022
Petroleum Supply Annual 1993, Volumes 1 and 2, Energy Information Administration, US DOE, Washington DC, June 1994.	Total US Imports in 1000 BPD: For 1993 = 6787; For 1992 = 6083		
Wetherold, R.G., G.E. Harris, F.D. Skinner, and L.P. Provost (Radian Corporation). "A Model for Evaluation of Refinery and Synfuels VOC Emission Data: Volumes 1 and 2." Research Triangle Park, NC.	EFs lb VOC/1000 gal		

TABLE A-7a. REFINERY EMISSION DATABASE

Report Title	Overall Site	Fixed Roof Tanks	Floating Roof Tanks	Other Fugitives	Flange Connectors	Non-flanged Connectors
"Anthropogenic Methane Emissions in the United States: Estimates for 1990," Report to Congress, EPA 430-R-93-003, April 1993.			Oil storage tank emissions given.			
"Compilation of Air Pollutant Emission Factors (AP-42)," US EPA.	AFs given for oil refinery with 330000 bbl/d capacity.			Non-methane emission factors given for fugitive components	600 #VOC/d, 46500 flanges	
"Development of Fugitive Emission Factors and Emission Profiles for Petroleum Marketing Terminals," Volume I and II, API, Washington DC, May 1993.	EF reported as lb THC/hr			Gas - 0.0014, Light Liquid - 0.00025	Gas - 0.000067, Light Liquid - 0.000023	Flanged/hot specified
"Emissions of Greenhouse Gases in the United States 1987-1994," Energy Information Administration, November 1995.	Emissions reported as short tons CH4/bbl crude		Tank farms: 4.37e-7 ton CH4/bbl throughput	1.635e-6 ton CH4/bbl capacity		
"Evaporation Loss from Fixed-Roof Tanks", API Bulletin 2518, June 1962, Reaffirmed August, 1987.	Losses calculated as bbl/yr.	Equations given for breathing and working losses.				
"Global Emissions of Methane From Petroleum Sources", Prepared by Radian for API, February 1992.	U.S. 96,508 tons CH4/y	All tanks - 2,100 ton CH4/yr (based on throughput)	4.37e-7 ton CH4/bbl	92,100 ton CH4/yr equip. leaks		
"Hydrocarbon Emissions from Refineries," API Publication No. 928, American Petroleum Institute, Washington, DC, July 1973.		Gasoline 6700, Crude 5200 ton HC/yr				
"Methane Emissions from the Oil and Gas Production Industries," Ruhrgas A.G., July 1989.	0.4 bcm CH4/yr from refineries worldwide	0.4% of refinery throughput will evaporate	0.05% of refinery throughput will evaporate			
DeLuchi, M.A., "Emissions from the Production, Storage, and Transport of Crude Oil and Gasoline," Journal of Air and Waste Management Association, Nov. 1993, pp. 1486-1495.	Emissions reported as g VOC/gal fuel consumed by motorists	0.035	0.133			

(Continued)

TABLE A-7a. REFINERY EMISSION DATABASE  
(Continued)

Report Title	Overall Site	Fixed Roof Tanks	Floating Roof Tanks	Other Fugitives	Flange Connectors	Non-flanged Connectors
Lipton, Sydney, "Fugitive Emissions," Chemical Engineering Progress, Vol. 85, No. 6, pp. 42-47, June 1989.	Emissions reported as # THC/hr/source			Sampling 0.033 THC/hr/source	0.00056 # THC/hr/source	
Petroleum Supply Annual 1993, Volumes 1 and 2, Energy Information Administration, US DOE, Washington DC, June 1994.	Provides # of refineries and volume of crude received.					
Radian Corporation. "Assessment of Atmospheric Emissions from Petroleum Refining: Volume 1." Prepared for U.S. Environmental Protection Agency. Research Triangle Park, NC. Contract No. 68-02-2147. July 1980.	Non CH4 HC EFs lb/hr-source				0.00056	
Radian Corporation. "Study of Refinery Fugitive Emissions from Equipment Leaks." API Health and Environmental Sciences Dept. and Western States Petroleum Assoc., Volumes 1 and 2, April 1994.					4.9e-7	1.7e-6
Rosebrook, D.D., R.G. Wetherold, and L.P. Provost, "The Development of Fugitive Emission Factors for the Petroleum Refining Industry", Presented at the 72nd Annual Meeting of the Air Pollution Control Association, June 1979.	Emissions reported as lb/hr/source				Gas/Vapor, Light Liquid - 0.0005, Heavy Liquid - 0.0007,	All - 0.00058 (general flanges)
Wetherold, R.G., G.E. Harris, F.D. Skinner, and L.P. Provost (Radian Corporation). "A Model for Evaluation of Refinery and Synfuels VOC Emission Data: Volumes 1 and 2." Research Triangle Park, NC. EPA Contract No.	EFs lb VOC/day/source				0.013	Flanged/not specified

TABLE A-7b. REFINERY EMISSION DATABASE

Report Title	Overall Site	Catalytic Processes	Fluid Coking
"Compilation of Air Pollutant Emission Factors (AP-42)," US EPA.	THC emissions as lb/1000 bbl feed	Fluid - 220, moving bed - 87	ND
"Global Emissions of Methane From Petroleum Sources", Prepared by Radian for API, February 1992.	Separation processes EF = 1.635e-5 ton CH4/bbl		
"Hydrocarbon Emissions from Refineries," API Publication No. 928, American Petroleum Institute, Washington, DC, July 1973.	Model refinery based on 100,000 bbl/d	Catalytic regeneration: 220 lb HC/1000 bbl feed to FCC; 87 lb HC/1000 bbl feed to TCC	
"Worldwide Refining," Oil and Gas Journal, Dec. 21, 1992, p 84.	U.S. Crude Capacity 15,209,853 b/cd; Throughputs by process also given.		
C.E. Burklin, and R.L. Honercamp, "Revision of Evaporative Hydrocarbon Emission Factors," EPA-450/3-76-039, U.S. Environmental Protection Agency, Research Triangle Park, NC, August 1977.	2101000 ton HC/yr	220 lb HC/1000 bbl feed	Negligible
Petroleum Supply Annual 1993, Volumes 1 and 2, Energy Information Administration, US DOE, Washington DC, June 1994.	Operable capacity of process units, 1000 bbl/d	9259 (includes hydrocrack & thermal crack units)	
R.F. Boland, et al., Screening Study for Miscellaneous Sources of Hydrocarbon Emissions in Petroleum Refineries, USEPA, Dec. 1976.			
Radian Corporation. "Assessment of Atmospheric Emissions from Petroleum Refining: Volume 1." Prepared for U.S. Environmental Protection Agency. Research Triangle Park, NC. Contract No. 68-02-2147. July 1980.	Component counts for process units given.		
Wetherold, R.G., G.E. Harris, F.D. Skinner, and L.P. Provost (Radian Corporation). "A Model for Evaluation of Refinery and Synfuels VOC Emission Data: Volumes 1 and 2." Research Triangle Park, NC.	EFs lb VOC/1000 bbl fresh feed	No Emission Control - 220	No Emission Control - 135

TABLE A-7c. REFINERY EMISSION DATABASE

Report Title	Open Ended Lines	Pump Seals	Compressor Seals	Valves	Pressure Relief Valves (PVR)	Flares	Other
"Anthropogenic Methane Emissions in the United States: Estimates for 1990," Report to Congress, EPA 430-R-93-003, April 1993.							Waste gas stream 10.4 kg CH <sub>4</sub> /yr from 10 refineries
"Compilation of Air Pollutant Emission Factors (AP-42)," US EPA.		1300 # VOC/d; 350 seals	1100 #VOC/d, 70 seals	6800 #VOC/day, 11500 valves	500 #VOC/d, 100 PRVs		650 drains, 1000#VOC/d; Cooling tower 1600; Separator 32100
"Development of Fugitive Emission Factors and Emission Profiles for Petroleum Marketing Terminals," Volume I, API, Washington DC, May 1993.	Gas - 0.0067, Light Liquid - 0.0065	Light Liquid - 0.00093		Gas - 0.00016, Light Liquid - 0.00015	Gas - 0.0014, Light Liquid - 0.00025		Loading arm valves: Gas - 0.045, Light Liquid - 0.00087
"Emissions of Greenhouse Gases in the United States 1987-1994," Energy Information Administration, November 1995.						4e-7 ton CH <sub>4</sub> /bbl capacity	
"Global Emissions of Methane From Petroleum Sources", Prepared by Radian for API, February 1992.						2.300 t CH <sub>4</sub> /y (4e-7 ton/bbl)	
"Hydrocarbon Emissions from Refineries," API Publication No. 928, American Petroleum Institute, Washington, DC, July 1973.		200 ton HC/yr			75-350 ton HC/yr		
"Methane Emissions from the Oil and Gas Production Industries," Ruhrgas A.G., July 1989.						0.15-0.5% feedstock to flare	
C.E. Burklin, et al., "Revision of Emission Factors for Petroleum Refining," EPA-450/3-77-030, U.S. Environmental Protection Agency, Research Triangle Park, NC, October 1977.						0.8 lb HC/1000 bbl	Reciprocating Compressor: 1.4 lb HC/ 1000 ft <sup>3</sup> , Turbine 0.02 lb HC/1000 ft <sup>3</sup>

(Continued)

TABLE A-7c. REFINERY EMISSION DATABASE  
(Continued)

Report Title	Open Ended Lines	Pump Seals	Compressor Seals	Valves	Pressure Relief Valves (PVR)	Flares	Other
DeLuchi, M.A., "Emissions from the Production, Storage, and Transport of Crude Oil and Gasoline," Journal of Air and Waste Management Association, Nov. 1993, pp. 1486-1495.							General storage @ refineries = 0.155
Lipton, Sydney, "Fugitive Emissions," Chemical Engineering Progress, Vol. 85, No. 6, pp. 42-47, June 1989.		Light Liquid - 0.25; Heavy Liquid - 0.046	1.4 # THC/hr/ source	Gas - 0.059, Light Liquid - 0.024, Heavy Liquid - 0.00051	0.36 # THC/hr/ source		Drains - 0.07 lb/hr/source
M.G. Klett and J.B. Galeski, "Flare Systems Study," EPA-600/2-76-079, U.S. Environmental Protection Agency, Research Triangle Park, NC, March 1976.						5 lb HC/1000 bbl refining capacity	
R.F. Boland, et al., Screening Study for Miscellaneous Sources of Hydrocarbon Emissions in Petroleum Refineries, USEPA, Dec. 1976.		17 lb HC/ 1000 bbl	5 lb HC/1000 bbl	Valves and flanges = 28 lb HC/1000 bbl capacity	11 lb HC/1000 bbl capacity		Drains & wastewater separators. 200 lb HC/1000 bbl water
Radian Corporation. "Assessment of Atmospheric Emissions from Petroleum Refining: Volume I." Prepared for U.S. Environmental Protection Agency. Research Triangle Park, NC. Contract No. 68-02-2147. July 1980.	0.005	Light Liquid- 0.25; Heavy Liquid-0.046	HC-1.4	Gas-0.059 Light Liquid- 0.024 Heavy Liquid- 0.0005	0.19		Drains 0.07 (Confidence bounds given)
Radian Corporation. "Study of Refinery Fugitive Emissions from Equipment Leaks," API Health and Environmental Sciences Dept. and Western States Petroleum Assoc., Volumes 1 and 2, April 1994.	5.7e-7	Heavy Liquid 4.3e-7		6.6e-6	1.9e-8		Light Liquid Pump Seal: 7.3e-6 (Confidence bounds given)

(Continued)

TABLE A-7c. REFINERY EMISSION DATABASE  
(Continued)

Report Title	Open Ended Lines	Pump Seals	Compressor Seals	Valves	Pressure Relief Valves (PVR)	Flares	Other
Rosebrook, D.D., R.G. Wetherold, and L.P. Provost, "The Development of Fugitive Emission Factors for the Petroleum Refining Industry", Presented at the 72nd Annual Meeting of the Air Pollution Control Association, June 1979.		Light Liquid-0.26; Heavy Liquid-0.045	Service: HC - 0.98, Hydrogen - 0.1	Gas/Vapor - 0.047, Light Liquid-0.023, Heavy Liquid-0.007	Gas/Vapor - 0.36, Light Liquid - 0.013, Heavy Liquid - 0.019, all - 0.19		Drains: Light Liquid 0.085, Heavy Liquid 0.029, All 0.07
Wetherold, R.G., G.E. Harris, F.D. Skinner, and L.P. Provost (Radian Corporation). "A Model for Evaluation of Refinery and Synfuels VOC Emission Data: Volumes 1 and 2." Research Triangle Park, NC.	0.12	Light Liquid-6; Heavy Liquid-1.1	HC Gas - 34, Hydrogen - 2.6	Light Liquid - 0.58, Heavy Liquid - 0.012, Gas - 1.4, Hydrogen - 0.43	Gas - 8.6, Liquid - 0.37	Flares = 0.8lb/1000 bbl crude	Drains 1.7; Cooling Towers 6 lb/10 <sup>6</sup> gal water; Wastewater treatment EFs given; Blowdowns = 0.8 lb/1000 bbl crude

TABLE A-7d. REFINERY EMISSION DATABASE

Report Title	Vacuum Distillation	Asphalt	Blowdown System	Other
"Compilation of Air Pollutant Emission Factors (AP-42)," US EPA.	Negligible			Reciprocating -1.4, Turbine - 0.02 #/1000 ft <sup>3</sup> burned
"Hydrocarbon Emissions from Refineries," API Publication No. 928, American Petroleum Institute, Washington, DC, July 1973.	Vacuum gas disposal 6570 ton HC/yr	asphalt blowing 165 ton HC/yr		
C.E. Burklin, and R.L. Honercamp, "Revision of Evaporative Hydrocarbon Emission Factors," EPA-450/3-76-039, U.S. Environmental Protection Agency, Research Triangle Park, NC, August 1977.	50 lb HC/1000 bbl	60 lb HC/ton asphalt	305-580 lb HC/1000 bbl capacity	Wastewater 5.2 lb/1000 gal; Also gives EFs for: boiler, compressor engine, cooling tower, vacuum jet, and overall refinery fugitives.
C.E. Burklin, et al., Oil and Gas Field Emission Survey, USEPA, Contract No. 68-D1-0031, April 1992.				Compressors: Reciprocating - 9.7, Turbine 0.2 lb HC/1000 hp-hr
Petroleum Supply Annual 1993, Volumes 1 and 2, Energy Information Administration, US DOE, Washington DC, June 1994.	15034			Isomerization, reforming and alkylation processes = 5459
R.F. Boland, et al., Screening Study for Miscellaneous Sources of Hydrocarbon Emissions in Petroleum Refineries, USEPA, Dec. 1976.			300 lb HC/1000 bbl capacity	
Radian Corporation. "Assessment of Atmospheric Emissions from Petroleum Refining: Volume 1." Prepared for U.S. Environmental Protection Agency. Research Triangle Park, NC. Contract No. 68-02-2147. July 1980.				Cooling Tower 0.000878(+/-0.00165)lb HC/1000 gal
Wetherold, R.G., G.E. Harris, F.D. Skinner, and L.P. Provost (Radian Corporation). "A Model for Evaluation of Refinery and Synfuels VOC Emission Data: Volumes 1 and 2." Research Triangle Park, NC.	Condenser Emission Control (EC) - 18	No EC - 60, Incinerator - 1.2 (lb VOC/ton asphalt)		



## **APPENDIX B**

### **Site Data**

## **APPENDIX B**

### **SITE DATA**

Table B-1 shows the sample data set for the site visits conducted for the GRI/EPA natural gas study of methane emissions from the natural gas study. This data set formed the basis for the oil production extrapolated equipment counts. See Section 4.1.1 for an explanation of the national equipment extrapolations methodology.

TABLE B-1. EPA PETROLEUM METHANE SITE DATA SUMMARY

Site Number	State	Oil Wells	Throughput (1000 B/D)	Separators	Heater Treaters	Pneumatic Devices	Chemical		
							Injection Pumps	Gas Lift Compressors	
1	TX-OFF	3	0.3	3	0	11	4	1	
2	LA-OFF	150	-	8	-	0	0	5	
3	LA-OFF	40	-	3	-	7	0	0	
4	CA-OFF	22	-	5	-	0	0	-	
5	LA	50	3.0	39	43	68	98	0	
6	LA	3	12.5	0	9	0	0	0	
7	TX	3	3	1	0	0	0	0	
8	TX	300	50	200	500	375	60	0	
9	TX	155	5.7	39	-	15	0	0	
10	TX	127	3.2	36	-	36	0	15	
11	TX	1345	52	227	9	175	0	0	
12	TX	120	4.3	80	0	160	173	14	
13	OK	55	3.55	10	140	179	0	0	
14	OK	11	2.95	3	5	36	0	0	
15	MT	4	15	4	-	0	0	-	

(Continued)

TABLE B-1. EPA PETROLEUM METHANE SITE DATA SUMMARY  
(Continued)

Site Number	State	Oil Wells	Throughput (1000 B/D)	Separators	Heater Treaters	Pneumatic Devices	Chemical Injection Pumps	Gas Lift Compressors
16	CA	913	71	200	0	0	666	37
17	CA	18	0.3	8	1	13	0	0
18	CA	8	0.03	4	2	3	1	0
19	CA	10	0.03	2	0	0	0	0
20	CA	15	0.07	3	0	0	0	0
21	CA	20	0.143	19	0	0	0	0
22	CA	7	0.09	3	0	5	1	0
23	CA	728	47.9	-	-	0	0	-
24	CA	4	0.0125	1	0	1	0	0
25	OH	163	-	163	-	163	0	-
26	OH	418	-	418	-	418	2	-

Note: The data for compressor starts and blowdowns are based on the number of gas-lift compressors. This information was gathered through follow-up calls to sites visited during the natural gas study. For one of the sites, electric-driven reciprocating compressors were used for artificial lift (CO<sub>2</sub> injection for this particular site). Since the compressors are electric driven, there are no methane emissions associated with compressor startup or blowdown. However, the compressors still handle a gas stream, so fugitive methane emissions could result. For this particular site, however, the gas concentration was over 80% CO<sub>2</sub> (the compressors were used to move gas to and from a CO<sub>2</sub> gas plant), which means that less than 20% of the gas being recovered could contain methane and/or other trace compounds. Because the percentage of methane is so small for this site, the extrapolation was simplified by not including the gas-lift compressors from this site in the extrapolation of compressors for fugitive emissions.

**APPENDIX C**  
**Statistical Analysis**

## APPENDIX C STATISTICAL ANALYSIS

Tables C-1 and C-2 show the statistical analysis for the oil production equipment extrapolations. The equipment was shown previously in Table 5-4. The statistical analysis is based on the methods presented in Sections 4.1 and 4.2.

TABLE C-1. STATISTICAL ANALYSIS FOR EXTRAPOLATED ACTIVITY FACTORS  
WELL BASIS

Equipment	n	Sample Wells/n	N	f	t
Separators	25	158.5	3,683	0.00679	1.711
Heater Treaters	17	169.7	3,441	0.00494	1.746
Pneumatic Devices	26	180.4	3,236	0.00804	1.708
Chemical Injection Pumps	26	180.4	3,236	0.00804	1.708
Gas-Lift Compressors	21	159.9	3,653	0.00575	1.725

Equipment	$\bar{x}$	$\bar{y}$	$\hat{R}$	$\hat{Y}_R$	$u(\hat{Y}_R)$	tsqrt(u)	90% Confidence Interval
Separators	158.5	59.1	0.373	217,804	4,198,966,996	110,864	50.9%
Heater Treaters	169.7	41.7	0.246	143,491	15,303,125,160	215,976	150.5%
Pneumatic Devices	180.4	64.0	0.355	207,217	7,457,682,234	147,511	71.2%
Chemical Injection Pumps	180.4	38.7	0.214	125,088	5,912,326,706	131,342	105.0%
Gas-Lift Compressors	159.9	3.4	0.021	12,523	46,651,936	11,780	94.1%

Note:

$\bar{x}$  and  $\bar{y}$  are the average number of wells and equipment per site in the sample data set, respectively.

$\hat{Y}_R$  is the extrapolated equipment count.

$t$  is the Student's  $t$  Distribution with  $n-1$  degrees of freedom.

$u$  = variance

$n$  = number of sites sampled;

$N$  = the total number of sites nationally;

$f$  = sampling fraction =  $n/N$ ; and

$\hat{R}$  = activity factor ratio =  $(AF/EP)_{\text{sample}}$

TABLE C-2. STATISTICAL ANALYSIS FOR EXTRAPOLATED ACTIVITY FACTORS  
THROUGHPUT BASIS

Equipment	n	Sample Wells/n	N	f	t
Separators	20	11.4	603	0.03319	1.729
Heater Treaters	17	12.0	572	0.02970	1.746
Pneumatic Devices	21	13.1	523	0.04019	1.725
Chemical Injection Pumps	21	13.1	523	0.04019	1.725
Gas-Lift Compressors	19	11.2	613	0.03100	1.734

Equipment	$\bar{x}$	$\bar{y}$	$\hat{R}$	$\hat{Y}_R$	$u(\hat{Y}_R)$	tsqrt(u)	90% Confidence Interval
Separators	11.4	44.1	3.880	26,562	16,516,733	7,027	26.5%
Heater Treaters	12.0	41.7	3.487	23,873	252,393,777	27,737	116.2%
Pneumatic Devices	13.1	51.3	3.915	26,800	127,148,788	19,448	72.6%
Chemical Injection Pumps	13.1	47.8	3.646	24,959	178,189,572	23,023	92.2%
Gas-Lift Compressors	11.2	3.5	0.316	2,162	1,183,252	1,886	87.3%

Note:

$\bar{x}$  and  $\bar{y}$  are the average throughput (1000 bbl/day/site) in the sample data set, respectively.  
 $\hat{Y}_R$  is the extrapolated equipment count.





## **APPENDIX D**

### **Hypothetical Examples of Extrapolation and Bias**

**APPENDIX D**  
**HYPOTHETICAL EXAMPLES OF EXTRAPOLATION AND BIAS**

If an equipment type were related to a single extrapolation parameter, yet extrapolated by another parameter, the extrapolation will be correct or biased to the degree that the relation between the extrapolation parameters at the site is correct or biased. See the simple cases below for examples.

**Case Example 1**

Hypothesis: Equipment is related only to production rate, yet was extrapolated by well count.

Data: Sample set has a high production rate per well.

$$E = \text{Equipment, } P = \text{Production, } W = \text{Wells} \quad \text{(D-1)}$$

$$\text{True, accurate extrapolation} = \left( \frac{E}{P} \right)_{\text{site}} \times P_{\text{national}} = E_{\text{national}} \quad \text{(D-2)}$$

$$\text{Actual extrapolation used: } \left( \frac{E}{W} \right)_{\text{site}} \times W_{\text{national}} \neq E_{\text{national}} \quad \text{(D-3)}$$

$$\left( \frac{E}{W} \right)_{\text{site}} = \left( \frac{E}{P} \right)_{\text{site}} \left( \frac{P}{W} \right)_{\text{site}} \quad \text{where } \left( \frac{E}{P} \right)_{\text{site}} \text{ is accurate,} \quad \text{(D-4)}$$

$$\text{Therefore, } \left( \frac{E}{W} \right)_{\text{site}} \text{ is biased by } \left( \frac{P}{W} \right)_{\text{site}}, \text{ which is } \underline{\text{HIGH}} \quad \text{(D-5)}$$

Conclusion: Well count extrapolation will overestimate the actual value in this case.

### Case Example 2

Hypothesis: Equipment is related only to well count, yet was extrapolated by production.

Data: Sample set has a high production rate per well.

$$\text{True, accurate extrapolation} = \left( \frac{E}{W} \right)_s \times W_n = E_n \quad \text{(D-6)}$$

$$\text{Actual extrapolation used: } \left( \frac{E}{P} \right)_s \times P_n = E_n \quad \text{(D-7)}$$

$$\left( \frac{E}{P} \right)_s = \left( \frac{E}{W} \right)_s \left( \frac{W}{P} \right)_s \text{ where } \left( \frac{E}{W} \right)_s \text{ is accurate,} \quad \text{(D-8)}$$

$$\text{Therefore, } \left( \frac{E}{P} \right)_s \text{ is biased by } \left( \frac{W}{P} \right)_{\text{site}}, \text{ which is } \underline{\text{LOW}} \quad \text{(D-9)}$$

Conclusion: production rate extrapolation will underestimate the actual value in this case.



**APPENDIX E**

**Production Fugitive Emission Factors**

## APPENDIX E PRODUCTION FUGITIVE EMISSION FACTORS

The purpose of this appendix is to briefly discuss the data sources and development of fugitive emission factors from leaking valves and fittings. The component method used here involves using an average emission factor for each type of fitting that comprise a facility. The average emission factor for each component type was determined by measuring the emission rate from a large number of randomly selected components from similar types of facilities across the country. The component emission factor is next combined with the average number of components associated with major equipment or facilities to determine the average estimate of emissions per equipment/facility.

Two reports were analyzed to determine fugitive emission factors for production. The first report was API Report 4615.<sup>1</sup> The second was the 1995 EPA Protocols document<sup>2</sup>, which includes EPA-approved fugitive component emission factors for oil and gas production. The API report was chosen because it contained information not in the EPA Protocols. The API report contained the methane fraction for light and heavy crude and the component count data. Table E-1 presents the resulting fugitive methane emission factors for oil industry equipment. Only onshore fugitive equipment is presented.

TABLE E-1. CH<sub>4</sub> FUGITIVE EMISSION FACTORS (OIL INDUSTRY)

Emission Source	Equipment EF	Units
Oil wellheads (heavy crude)	0.83	scfd CH <sub>4</sub> /well
Oil wellheads (light crude)	19.58	scfd CH <sub>4</sub> /well
Separators (heavy crude)	0.85	scfd CH <sub>4</sub> /separator
Separators (light crude)	51.33	scfd CH <sub>4</sub> /separator
Heater/Treaters (light crude)	59.74	scfd CH <sub>4</sub> /heater
Headers (heavy crude)	0.59	scfd CH <sub>4</sub> /header
Headers (light crude)	202.78	scfd CH <sub>4</sub> /header
Compressors (light crude)		
Small	46.14	scfd CH <sub>4</sub> /compressor
Large	16,360	scfd CH <sub>4</sub> /compressor
Sales Areas	40.55	scfd CH <sub>4</sub> /sales area

<sup>1</sup>Star Environmental. API Publication No. 4615. "Emission Factors for Oil and Gas Production Operations." American Petroleum Institute, January 1995.

<sup>2</sup>U.S. EPA. EPA-453/R-95-017. "1995 Protocol for Equipment Leak Emission Estimates." U.S. Environmental Protection Agency, November 1995.

The next step in estimating the national emissions from equipment leaks from oil industry production equipment is to estimate the number of each type of equipment. This was done by ratioing the other equipment as a function of the number of wellheads. Table E-2 lists the relative population of other production equipment versus well counts according to the API field counts.

TABLE E-2. RELATIVE POPULATIONS OF FIELD EQUIPMENT  
PER API DATA

Equipment Type	Light Crude	Heavy Crude
Wells	241	183
Separators	47	5
Headers	21	68
Tanks	24	--
Scrubber	10	--
Sales	10	--
Meters	12	--
Instruments	8	--
Heaters	34	--
Compressors	6	--

For example, the ratio of light crude headers to light crude wellheads is  $21/241 = 0.087$  (or, 8.7 headers per 100 light crude wells). As explained in the body of this report, the national population of light crude and heavy crude wellheads was estimated separately because both the equipment emission factors and the field equipment populations were significantly different for light crude and heavy crude. These reasons include: 1) different component emission factors-the light crude component emission factors are one or two orders of magnitude higher; 2) different component counts-the light crude separators and headers have significantly more components; and 3) there are up to 12 field equipment types listed for light crude, versus only 3 for heavy crude.

The underlying basis for the equipment emission factors are the counts and component emission factors. As described in the API and EPA reports, there are several component types such as connections, flanges, open-ended lines, valves, and other miscellaneous fittings. Comparisons of the emission factors between the API and EPA reports were made to ensure that the use of API or EPA factors would produce similar results for a given component type. Table E-3 provides a comparison of THC fugitive emission factors between API 4615 and EPA Protocols.

TABLE E-3. COMPARISON BETWEEN LIGHT CRUDE AND HEAVY CRUDE  
EMISSION FACTORS IN API/STAR 4615

Component Emission Factor (lb THC/day)					
Service	Connection	Flange	Open-Ended Line	Valve	Other
Light Crude	8.66E-03 <i>(20 times higher)</i>	4.07E-03 <i>(3.5 times higher)</i>	6.38E-02 <i>(7.8 times higher)</i>	7.00E-02 <i>(102 times higher)</i>	3.97E-01 <i>(107 times higher)</i>
Heavy Crude	4.22E-04	1.16E-03	8.18E-03	6.86E-04	3.70E-03

COMPARISON BETWEEN API 4615 AND EPA PROTOCOLS  
(FEBRUARY 1996)

Component Emission Factor (lb THC/day)						
Service	Basis	Connection	Flange	Open-Ended Line	Valve	Other
Light Crude	API 4615	8.66E-03	4.07E-03	6.38E-02	7.00E-02	3.97E-01
	EPA	1.1E-02	5.8E-03	7.4E-02	1.32E-01	3.97E-01
Heavy Crude	API 4615	4.22E-04	1.16E-03	8.18E-03	6.86E-04	3.70E-03
	EPA	3.97E-04	2.1E-05	7.4E-03	4.4E-04	1.7E-03

The data in Table E-3 show that the light crude component emission factors are higher than the heavy crude factors. While some differences exist between API and EPA factors, in most cases the values are similar and if EPA factors were used instead, the fugitive estimates in this report would not differ drastically.



## **APPENDIX F**

### **Tank Flash Calculations**

## APPENDIX F TANK FLASH CALCULATIONS

Methane emissions from a fixed-roof crude oil gathering tank were calculated using a process flow model and standard design parameters for oil field equipment. It was assumed that the crude oil in the gathering tank was separated from well head gas in a standard gas/oil separator upstream of the gathering tank. It was also assumed that the crude oil leaves the gas/oil separator in equilibrium with a pure methane stream that has been separated from the oil. The oil leaving the separator contains dissolved methane in equilibrium with the temperature and pressure of the separator. When the crude oil enters the gathering tank which operates at near atmospheric pressure, the dissolved methane is flashed to the vapor phase and vented from the tank. The assumption of being in equilibrium with pure methane results in conservatively high estimates for gathering tank methane emissions.

The ASPEN Plus process simulator model was used to calculate the oil field gathering tank emissions. The process flow configuration modeled in ASPEN is shown in Figure F-1. The separator temperature and pressure were varied across the standard range of process conditions experienced in the oil field to test the sensitivity of the methane emissions to standard process conditions. The crude oil was assumed to be an East Texas Intermediate Crude, (however analysis done later proved that the choice of the crude oil had minimal impact on the emissions from the gathering tanks). The crude oil entering the gathering tank was assumed to be at the same temperature as the gas/oil separator, and the pressure of the crude gathering tank was assumed to be 14.8 psia (~0.1 psig) for all cases.

Table F-1 presents the results from the ASPEN Plus process simulation for oil field gathering tanks. The methane emission rates from the gathering tank range from 7.3 to 27.1 scf/bbl of oil throughput. The annual US crude production of 2.339 billion barrels of crude yields an annual methane emission rate of 17.1 to 63.4 Bscf CH<sub>4</sub>/yr. For comparison the ASPEN model was used to calculate the annual methane emissions from natural gas field condensate. As shown in Table F-2, annual emissions are (5.1 to 18.3 scf/bbl) × 788 million barrels of condensate/yr = 4.02 to 14.4 Bscf CH<sub>4</sub>/yr.

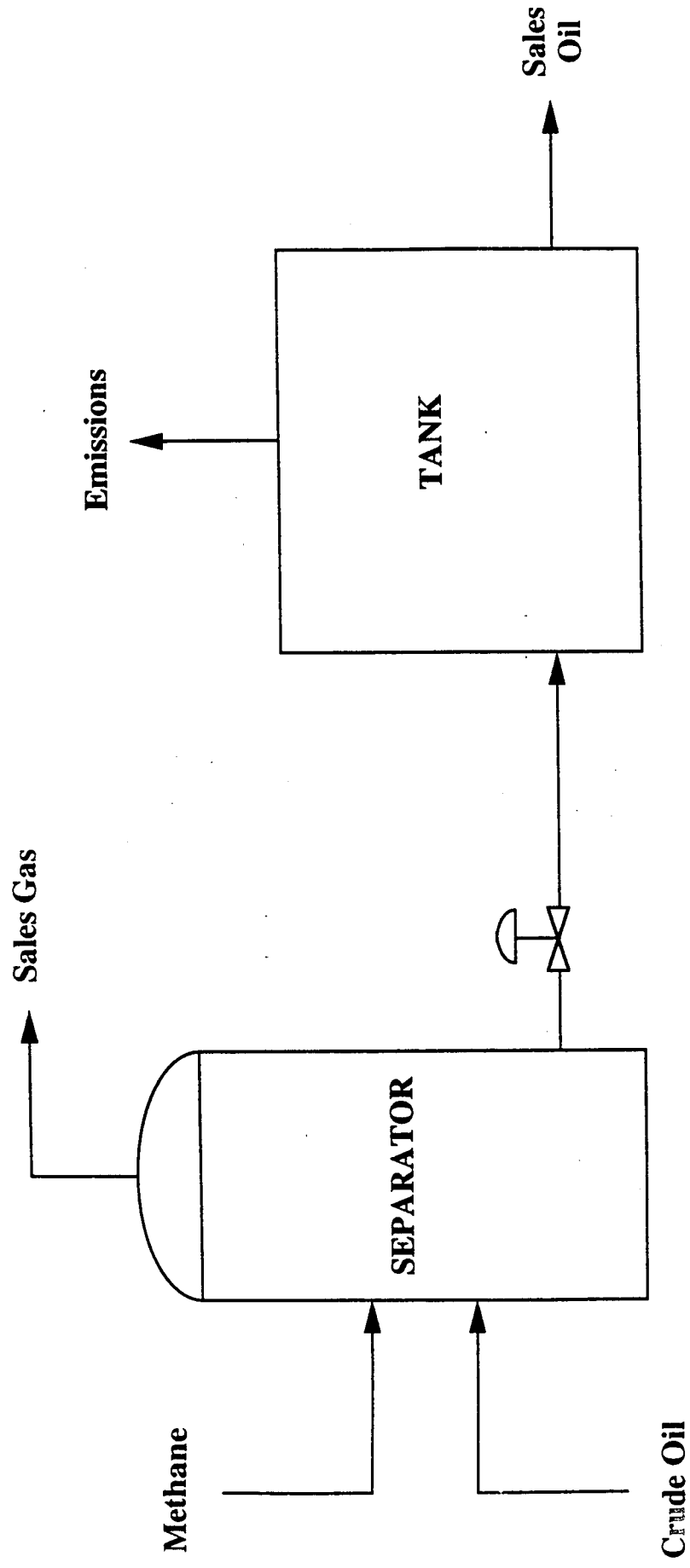

F-3

Figure F-1. Process Flow Diagram for Simulations to Determine Methane Emissions from Oil/Condensate Production Tanks

TABLE F-1. METHANE EMISSIONS FROM CRUDE OIL TANKS  
WITH VARIOUS PROCESS CONDITIONS

Case	Separator T (°F)	Separator P (psig)	Methane Emissions (scf/bbl)
1	60	20	8.8
2	60	40	17.9
3	60	60	27.1
4	85	20	7.8
5	85	40	15.9
6	85	60	24.1
7	100	20	7.3
8	100	40	14.9
9	100	60	22.6

TABLE F-2. METHANE EMISSIONS FROM CRUDE OIL TANKS  
WITH VARIOUS PROCESS CONDITIONS

Case	Separator T (°F)	Separator P (psig)	Methane Emissions (scf/bbl)
1	60	20	6.0
2	60	60	18.3
3	85	20	5.4
4	85	40	10.9
5	85	60	16.5
6	100	20	5.1
7	100	60	15.6

**APPENDIX G**

**English/Metric Conversions**

## APPENDIX G

### Unit Conversion Table English to Metric Conversions

1 scf methane	=	19.23 g methane
1 Bscf methane	=	0.01923 Tg methane
1 Bscf methane	=	19,230 metric tonnes methane
1 Bscf	=	28.32 million standard cubic meters
1 short ton (ton)	=	907.2 kg
1 lb	=	0.4536 kg
1 ft <sup>3</sup>	=	0.02832 m <sup>3</sup>
1 ft <sup>3</sup>	=	28.32 liters
1 gallon	=	3.785 liters
1 barrel (bbl)	=	158.97 liters
1 inch	=	2.540 cm
1 ft	=	0.3048 m
1 mile	=	1.609 km
1 hp	=	0.7457 kW
1 hp-hr	=	0.7457 kW-hr
1 Btu	=	1055 Joule
1 MMBtu	=	293 kW-hr
1 lb/MMBtu	=	430 g/GJ
T (°F)	=	1.8 T (°C) + 32
1 psi	=	51.71 mm Hg

#### Notes

scf	=	Standard cubic feet. Standard conditions are at 14.73 psia and 60°F.
Bscf	=	Billion standard cubic feet (10 <sup>9</sup> scf).
MMscf	=	Million standard cubic feet.
Mscf	=	Thousand standard cubic feet.
Tg	=	Teragram (10 <sup>12</sup> g).
Giga (G)	=	Same as billion (10 <sup>9</sup> ).
Metric tonne	=	1000 kg.
psig	=	Gauge pressure.
psia	=	Absolute pressure (note psia = psig + atmospheric pressure).

**APPENDIX H**

**Methane Emissions 1986-1992**

**Table H-1  
1986 Methane Emission Estimate  
Petroleum - Production**

<b>Emission Source</b>	<b>Emission Factor</b>	<b>Methane Emissions Units</b>	<b>Confidence Interval</b>	<b>Activity Factor</b>	<b>Activity Units</b>	<b>Confidence Interval</b>	<b>Emissions (Bscf)</b>	<b>Confidence Interval</b>
Annual Production				8,680,000	bb/d	5%		
% Heavy Crude (API<20°)				11.7%		100%		
Total Producing Oil Wells 1993				623,000	wells	5%		
% Heavy Wells (API<20°)				7.3%		100%		
<b>Fugitives:</b>								
Offshore Platforms	2914	scfd CH4/platform	27%	1,092	platforms	10%	1.161	29%
Gulf of Mexico	1178	scfd CH4/platform	36%	22	platforms	10%	0.009	38%
Rest of US	0.83	scfd CH4/well	30%	45,230	wells	100%	0.014	109%
Oil Wellheads (heavy crude)	19.58	scfd CH4/well	30%	577,770	wells	100%	4.129	109%
Oil Wellheads (light crude)	0.85	scfd CH4/sep	30%	10,402	separators	78%	0.003	87%
Separators (heavy crude)	51.33	scfd CH4/sep	30%	122,627	separators	78%	2.297	87%
Separators (light crude)	59.74	scfd CH4/heater	30%	84,374	heater treaters	128%	1.840	137%
Heater/Treaters (light crude)	0.59	scfd CH4/header	30%	16,807	headers	109%	0.004	118%
Headers (heavy crude)	202.78	scfd CH4/header	30%	50,345	headers	109%	3.726	118%
Headers (light crude)	34.4	scfd CH4/tank	30%	57,777	tanks	109%	0.725	118%
Tanks (light crude)								
Compressors (light crude)								
Small	46.14	scfd CH4/comp	100%	706	small g.l. comp.	90%	0.012	162%
Large	16,360	scfd CH4/comp	100%	2,118	large g.l. comp.	90%	12.646	162%
Sales Areas	40.55	scfd CH4/area	30%	4,443	sales areas	46%	0.066	57%
Pipelines	56.4	scfd CH4/mile	97%	70,000	miles	50%	1.441	119%
<b>Venting:</b>								
Oil Tanks	12.1	scfd CH4/bbl	88%	8,680,000	bb/d	5%	38.335	88%
Pneumatic Devices	345	scfd CH4/device	40%	127,541	pneumatics	78%	16.061	93%
CIPs	248	scfd CH4/pump	83%	133,447	CIPs	105%	12.080	160%
Vessel Blowdowns	78	scfy CH4/vessel	266%	224,729	sep. and h.t.	70%	0.018	332%
Compressor Starts	8443	scfy CH4/comp.	157%	3,069	gas lift comp.	79%	0.026	216%
Compressor Blowdowns	3774	scfy CH4/comp.	147%	3,069	gas lift comp.	79%	0.012	204%
Completion Flaring	733	scfd CH4/completion	200%	989	completions	10%	0.265	201%
Well Workover	96	scf CH4/workover	200%	46,725	w.o./year	421%	0.004	962%
Casinghead Gas								
<b>Upsets:</b>								
ESD	256,888	scfy CH4/plat	200%	1,114	platforms	10%	0.286	201%
PRV Lifts	34	scfy CH4/PRV	252%	461,737	PRV	102%	0.016	374%
Well Blowout	250,000	scf CH4/blowout	200%	2.85	blowouts/yr	200%	0.001	490%
<b>Combustion Sources:</b>								
Gas Engines	0.24	scf CH4/HPhr	5%	19,337	MMhp-hr	275%	4.641	275%
Burners	0.526	lb CH4/1000 gal	10%	17,806,000	bb/year	5%	0.009	11%
Drilling	0.052	ton CH4/well drilled	100%	989	expl. wells	10%	0.002	101%
Flares								
<b>Total</b>							<b>99.83</b>	<b>48.8%</b>



**Table H-2  
1986 Methane Emission Estimate  
Petroleum - Crude Transportation**

<b>Emission Source</b>	<b>Emission Factor</b>	<b>Methane Emissions Units</b>	<b>Confidence Interval</b>	<b>Activity Factor</b>	<b>Activity Units</b>	<b>Confidence Interval</b>	<b>Emissions (Bscf)</b>	<b>Confidence Interval</b>
<b>Fugitives:</b>								
Pump Stations	1.06	lb CH <sub>4</sub> /yr/mile	100%	54,153	miles	100%	0.0014	173%
Pipelines	0.0	lb CH <sub>4</sub> /bbl	10%	6.29E+09	bb/yr	5%	0.0000	11%
Metering								
<b>Venting:</b>								
Tanks	4.37E-07	ton CH <sub>4</sub> /bbl	100%	8173000000	bb/yr	4%	0.169	100%
<b>Loading</b>								
Truck	1.02E-05	ton CH <sub>4</sub> /bbl	100%	7.48E+07	bb/yr	10%	0.036	101%
Marine	0.5	lb CH <sub>4</sub> /1000 gal crude	100%	7.52E+10	gal/yr	10%	0.892	101%
Rail Car	1.02E-05	ton CH <sub>4</sub> /bbl	100%	2.05E+07	bb/yr	10%	0.010	101%
<b>Maintenance:</b>								
Pump Stations	1.56	lb CH <sub>4</sub> /y/station	100%	542	stations	100%	0.000	173%
<b>Combustion Sources:</b>								
Pump engine drivers	0.24	scf CH <sub>4</sub> /HPHr	5%					
Heaters								
<b>Total</b>							<b>1.108</b>	<b>82.7%</b>

**Table H-3  
1986 Methane Emission Estimate  
Petroleum - Refining**

Emission Source	Emission Factor	Methane Emissions Units	Confidence Interval	% Methane in THC*	Activity Factor	Activity Units	Confidence Interval	Emissions (Bscf)	Confidence Interval
<b>Fugitives:</b>									
Fuel Gas System	1.02	MMscf CH4/heater/yr	100%		3,200	heaters	50%	3.26	122%
Pipe Stills									
Wastewater Treating	0.00798	lb VOC/bbl	100%	1.0%	12,715,257	b/d	5%	0.009	100%
Cooling Towers	0.01	lb VOC/bbl	100%	1.0%	12,715,257	b/d	5%	0.011	100%
<b>Venting:</b>									
Tanks	4.37E-07	ton CH4/bbl	100%		12,715,257	b/d	5%	0.096	100%
System Blowdowns	580	# HC/1000 bbc capacity	100%	1.0%	12,715,257	b/d	5%	0.638	100%
Process Vents									
PRVs									
<b>Combustion Sources:</b>									
Process Heaters:									
Atm. Distillation	0.30	lb THC/1000 bbl	100%	51.0%	12,715,257	b/d	5%	0.017	100%
Vacuum Distil.	0.30	lb THC/1000 bbl	100%	51.0%	5,662,334	b/d	5%	0.008	100%
Thermal Operations	0.50	lb THC/1000 bbl	100%	51.0%	1,566,299	b/d	5%	0.003	100%
Cat. Cracking	0.43	lb THC/1000 bbl	100%	51.0%	4,855,860	b/d	5%	0.009	100%
Cat. Reforming	0.60	lb THC/1000 bbl	100%	51.0%	3,147,793	b/d	5%	0.008	100%
Cat. Hydrocracking	0.60	lb THC/1000 bbl	100%	51.0%	966,926	b/d	5%	0.003	100%
Cat. Hydrorefining	0.18	lb THC/1000 bbl	100%	51.0%	1,935,990	b/d	5%	0.002	100%
Cat. Hydrotreating	0.54	lb THC/1000 bbl	100%	51.0%	5,634,335	b/d	5%	0.014	100%
Alkyl & Polymer.	1.05	lb THC/1000 bbl	100%	51.0%	805,044	b/d	5%	0.004	100%
Aromatics/isomeration	0.15	lb THC/1000 bbl	100%	51.0%	532,582	b/d	5%	0.000	100%
Lube Processing	0.0		100%		203,018	b/d	5%	0.000	100%
Asphalt	60	# HC/ton	100%	51.0%	581,578	b/d	5%	0.154	100%
Hydrogen	0.0		100%					0.000	100%
Coke	0	Included in Thermal Ops	100%						
Engines and Flares									
Engines	0.24	scf CH4/hp-hr	5%		20,334	MMhp-hr	100%	4.880	100%
Flares	0.0008	lb VOC/bbl	100%	1.0%	12,715,257	b/d	5%	0.001	100%
<b>Total</b>								9.117	69.70%

\* % Methane in VOC (volatile organic compounds) taken from AP-42 (Reference 28)  
 % Methane in HC (hydrocarbons) for system blowdowns is taken from AP-42  
 % Methane in THC (total hydrocarbons) calculated based on data from AP-42  
 % Methane in HC for asphalt calculated based on data from AP-42

**Table H-4  
1987 Methane Emission Estimate  
Petroleum - Production**

<b>Emission Source</b>	<b>Emission Factor</b>	<b>Methane Emissions Units</b>	<b>Confidence Interval</b>	<b>Activity Factor</b>	<b>Activity Units</b>	<b>Confidence Interval</b>	<b>Emissions (Bscf)</b>	<b>Confidence Interval</b>
Annual Production				8,349,000	bbl/d	5%		
% Heavy Crude (API<20°)				11.0%		100%		
Total Producing Oil Wells				620,000	wells	5%		
% Heavy Wells (API<20°)				7.4%		100%		
<b>Fugitives:</b>								
Offshore Platforms	2914	scfd CH4/platform	27%	1,092	platforms	10%	1.161	29%
Gulf of Mexico	1178	scfd CH4/platform	36%	22	platforms	10%	0.009	38%
Rest of US	0.83	scfd CH4/well	30%	45,942	wells	100%	0.014	109%
Oil Wellheads (heavy crude)	19.58	scfd CH4/well	30%	574,058	wells	100%	4.103	109%
Oil Wellheads (light crude)	0.85	scfd CH4/sep	30%	10,353	separators	78%	0.003	87%
Separators (heavy crude)	51.33	scfd CH4/sep	30%	121,474	separators	78%	2.276	87%
Separators (light crude)	59.74	scfd CH4/heater	30%	83,504	heater treaters	128%	1.821	137%
Heater/Treaters (light crude)	0.59	scfd CH4/header	30%	17,071	headers	109%	0.004	118%
Heaters (heavy crude)	202.78	scfd CH4/header	30%	50,022	headers	109%	3.702	118%
Headers (light crude)	34.4	scfd CH4/tank	30%	57,406	tanks	109%	0.721	118%
Tanks (light crude)								
Compressors (light crude)								
Small	46.14	scfd CH4/comp	100%	699	small g.l. comp.	90%	0.012	162%
Large	16,360	scfd CH4/comp	100%	2,096	large g.l. comp.	90%	12.514	162%
Sales Areas	40.55	scfd CH4/area	30%	4,443	sales areas	46%	0.066	57%
Pipelines	56.4	scfd CH4/mile	97%	70,000	miles	50%	1.441	119%
<b>Venting:</b>								
Oil Tanks	12.1	scf CH4/bbl	88%	8,349,000	bbl/d	5%	36.873	88%
Pneumatic Devices	345	scfd CH4/device	40%	126,361	pneumatics	78%	15.912	93%
CIPs	248	scfd CH4/pump	83%	132,804	CIPs	105%	12.021	160%
Vessel Blowdowns	78	scfy CH4/vessel	266%	222,582	sep. and h.t.	70%	0.017	332%
Compressor Starts	8443	scfy CH4/comp.	157%	3,037	gas lift comp.	80%	0.026	216%
Compressor Blowdowns	3774	scfy CH4/comp.	147%	3,037	gas lift comp.	80%	0.011	204%
Completion Flaring	733	scfd CH4/completion	200%	857	completions	10%	0.229	201%
Well Workover	96	scf CH4/workover	200%	46,500	w.o./year	421%	0.004	962%
Casinghead Gas								
<b>Upsets:</b>								
ESD	256,888	scfy CH4/plat	200%	1,114	platforms	10%	0.286	201%
PRV Lifts	34	scfy CH4/PRV	252%	457,313	PRV	102%	0.016	374%
Well Blowout	250,000	scf CH4/blowout	200%	2.85	blowouts/yr	200%	0.001	490%
<b>Combustion Sources:</b>								
Gas Engines	0.24	scf CH4/HPhr	5%	19,135	MMhp-hr	275%	4.592	275%
Burners	0.526	lb CH4/1000 gal	10%	12,497,000	bbl/year	5%	0.007	11%
Drilling	0.052	ton CH4/well drilled	100%	857	expl. wells	10%	0.002	101%
Flares								
<b>Total</b>							<b>97.84</b>	<b>48.7%</b>

**Table H-5  
1987 Methane Emission Estimate  
Petroleum - Crude Transportation**

<b>Emission Source</b>	<b>Emission Factor</b>	<b>Methane Emissions Units</b>	<b>Confidence Interval</b>	<b>Activity Factor</b>	<b>Activity Units</b>	<b>Confidence Interval</b>	<b>Emissions (Bscf)</b>	<b>Confidence Interval</b>
<b>Fugitives:</b>								
Pump Stations	1.06	lb CH4/yr/mile	100%	54,886	miles	100%	0.0014	173%
Pipelines	0.0	lb CH4/bbl	10%	6.28E+09	bbl/yr	5%	0.0000	11%
Metering								
<b>Venting:</b>								
Tanks	4.37E-07	ton CH4/bbl	100%	8293000000	bbl/yr	4%	0.172	100%
<b>Loading</b>								
Truck	1.02E-05	ton CH4/bbl	100%	6.82E+07	bbl/yr	10%	0.033	101%
Marine	0.5	lb CH4/1000 gal crude	100%	8.09E+10	gal/yr	10%	0.960	101%
Rail Car	1.02E-05	ton CH4/bbl	100%	2.08E+07	bbl/yr	10%	0.010	101%
<b>Maintenance:</b>								
Pump Stations	1.56	lb CH4/y/station	100%	549	stations	100%	0.000	173%
<b>Combustion Sources:</b>								
Pump engine drivers	0.24	scf CH4/HPHr	5%					
Heaters								
<b>Total</b>							1.176	83.8%

**Table H-6  
1987 Methane Emission Estimate  
Petroleum - Refining**

Emission Source	Emission Factor	Methane Emissions Units	Confidence Interval	% Methane in THC*	Activity Factor	Activity Units	Confidence Interval	Emissions (Bscf)	Confidence Interval
<b>Fugitives:</b>									
Fuel Gas System	1.02	MMscf CH4/heater/yr	100%		3,200	heaters	50%	3.26	122%
Pipe Stills	0.00798	lb VOC/bbl	100%	1.0%	12,853,848	b/d	5%	0.009	100%
Wastewater Treating	0.01	lb VOC/bbl	100%	1.0%	12,853,848	b/d	5%	0.011	100%
Cooling Towers									
<b>Venting:</b>									
Tanks	4.37E-07	ton CH4/bbl	100%		12,853,848	b/d	5%	0.097	100%
System Blowdowns	580	# HC/1000 bbc capacity	100%	1.0%	12,853,848	b/d	5%	0.645	100%
Process Vents									
PRVs									
<b>Combustion Sources:</b>									
Process Heaters:									
Atm. Distillation	0.30	lb THC/1000 bbl	100%	51.0%	12,853,848	b/d	5%	0.017	100%
Vacuum Distil.	0.30	lb THC/1000 bbl	100%	51.0%	5,861,768	b/d	5%	0.008	100%
Thermal Operations	0.50	lb THC/1000 bbl	100%	51.0%	1,571,033	b/d	5%	0.003	100%
Cat. Cracking	0.43	lb THC/1000 bbl	100%	51.0%	4,846,366	b/d	5%	0.009	100%
Cat. Reforming	0.60	lb THC/1000 bbl	100%	51.0%	3,201,246	b/d	5%	0.008	100%
Cat. Hydrocracking	0.60	lb THC/1000 bbl	100%	51.0%	980,399	b/d	5%	0.003	100%
Cat. Hydrotreating	0.18	lb THC/1000 bbl	100%	51.0%	1,882,196	b/d	5%	0.001	100%
Cat. Hydrorefining	0.54	lb THC/1000 bbl	100%	51.0%	5,713,742	b/d	5%	0.014	100%
Alkyl & Polymer.	1.05	lb THC/1000 bbl	100%	51.0%	832,898	b/d	5%	0.004	100%
Aromatics/Isomeration	0.15	lb THC/1000 bbl	100%	51.0%	604,089	b/d	5%	0.000	100%
Lube Processing	0.0	# HC/ton	100%	51.0%	197,448	b/d	5%	0.000	100%
Asphalt	60		100%		596,089	b/d	5%	0.158	100%
Hydrogen	0.0		100%					0.000	
Coke	0	Included in Thermal Ops	100%						
Engines and Flares	0.24	scf CH4/hp-hr	5%		20,334	MMhp-hr	100%	4.880	100%
Engines	0.0008	lb VOC/bbl	100%	1.0%	12,853,848	b/d	5%	0.001	100%
Flares									
<b>Total</b>								9.128	69.6%

\* % Methane in VOC (volatile organic compounds) taken from AP-42 (Reference 28)  
 % Methane in HC (hydrocarbons) for system blowdowns is taken from AP-42  
 % Methane in THC (total hydrocarbons) calculated based on data from AP-42  
 % Methane in HC for asphalt calculated based on data from AP-42

**Table H-7  
1988 Methane Emission Estimate  
Petroleum - Production**

Emission Source	Emission Factor	Methane Emissions Units	Confidence Interval	Activity Factor	Activity Units	Confidence Interval	Emissions (Bscf)	Confidence Interval
Annual Production				8,140,000	bb/d	5%		
% Heavy Crude (API<20°)				11.0%		100%		
Total Producing Oil Wells				612,000	wells	5%		
% Heavy Wells (API<20°)				7.3%		100%		
<b>Fugitives:</b>								
Offshore Platforms	2914	scfd CH4/platform	27%	1,092	platforms	10%	1.161	29%
Gulf of Mexico	1178	scfd CH4/platform	36%	22	platforms	10%	0.009	38%
Rest of US	0.83	scfd CH4/well	30%	44,921	wells	100%	0.014	109%
Oil Wellheads (heavy crude)	19.58	scfd CH4/well	30%	567,079	wells	100%	4.053	109%
Oil Wellheads (light crude)	0.85	scfd CH4/sep	30%	10,108	separators	78%	0.003	87%
Separators (heavy crude)	51.33	scfd CH4/sep	30%	119,821	separators	78%	2.245	87%
Separators (light crude)	59.74	scfd CH4/heater	30%	82,331	heater treaters	129%	1.795	138%
Heater/Treaters (light crude)	0.59	scfd CH4/heater	30%	16,692	headers	109%	0.004	118%
Headers (heavy crude)	202.78	scfd CH4/header	30%	49,414	headers	109%	3.657	118%
Headers (light crude)	34.4	scfd CH4/tank	30%	56,708	tanks	109%	0.712	118%
Compressors (light crude)								
Small	46.14	scfd CH4/comp	100%	689	small g.i. comp.	90%	0.012	162%
Large	16,360	scfd CH4/comp	100%	2,066	large g.i. comp.	90%	12.338	162%
Sales Areas	40.55	scfd CH4/area	30%	4,443	sales areas	46%	0.066	57%
Pipelines	56.4	scfd CH4/mile	97%	70,000	miles	50%	1.441	119%
<b>Venting:</b>								
Oil Tanks	12.1	scf CH4/bbl	88%	8,140,000	bb/d	5%	35.950	88%
Pneumatic Devices	345	scfd CH4/device	40%	124,532	pneumatics	78%	15.682	93%
CIPs	248	scfd CH4/pump	83%	131,090	CIPs	105%	11.866	160%
Vessel Blowdowns	78	scfy CH4/vessel	266%	219,337	sep. and h.t.	70%	0.017	332%
Compressor Starts	8443	scfy CH4/comp.	157%	2,992	gas lift comp.	80%	0.025	216%
Compressor Blowdowns	3774	scfy CH4/comp.	147%	2,992	gas lift comp.	80%	0.011	205%
Completion Flaring	733	scfd CH4/completion	200%	791	completions	10%	0.212	201%
Well Workover	96	scf CH4/workover	200%	45,900	w.o./year	421%	0.004	962%
Casinghead Gas								
<b>Upsets:</b>								
ESD	256,888	scfy CH4/plat	200%	1,114	platforms	10%	0.286	201%
PRV Lifts	34	scfy CH4/PRV	252%	450,642	PRV	102%	0.015	375%
Well Blowout	250,000	scf CH4/blowout	200%	2.85	blowouts/yr	200%	0.001	490%
<b>Combustion Sources:</b>								
Gas Engines	0.24	scf CH4/HP/hr	5%	18,849	MMhp-hr	275%	4.524	276%
Burners	0.526	lb CH4/1000 gal	10%	14,697,000	bb/year	5%	0.008	11%
Drilling	0.052	ton CH4/well drilled	100%	791	expl. wells	10%	0.002	101%
Flares								
<b>Total</b>							96.11	48.7%

**Table H-8  
1988 Methane Emission Estimate  
Petroleum - Crude Transportation**

<b>Emission Source</b>	<b>Emission Factor</b>	<b>Methane Emissions Units</b>	<b>Confidence Interval</b>	<b>Activity Factor</b>	<b>Activity Units</b>	<b>Confidence Interval</b>	<b>Emissions (Bscf)</b>	<b>Confidence Interval</b>
<b>Fugitives:</b>								
Pump Stations	1.06	lb CH4/yr/mile	100%	55,900	miles	100%	0.0014	173%
Pipelines	0.0	lb CH4/bbl	10%	6.51E+09	bbl/yr	5%	0.0000	11%
Metering								
<b>Venting:</b>								
Tanks	4.37E-07	ton CH4/bbl	100%	8668000000	bbl/yr	4%	0.180	100%
<b>Loading</b>								
Truck	1.02E-05	ton CH4/bbl	100%	6.81E+07	bbl/yr	10%	0.033	101%
Marine	0.5	lb CH4/1000 gal crude	100%	8.69E+10	gal/yr	10%	1.030	101%
Rail Car	1.02E-05	ton CH4/bbl	100%	2.22E+07	bbl/yr	10%	0.011	101%
<b>Maintenance:</b>								
Pump Stations	1.56	lb CH4/y/station	100%	559	stations	100%	0.000	173%
<b>Combustion Sources:</b>								
Pump engine drivers	0.24	scf CH4/HPhr	5%					
Heaters								
<b>Total</b>							1.255	84.2%

**Table H-9  
1988 Methane Emission Estimate  
Petroleum - Refining**

Emission Source	Emission Factor	Methane Emissions Units	Confidence Interval	% Methane in THC*	Activity Factor	Activity Units	Confidence Interval	Emissions (Bscf)	Confidence Interval
<b>Fugitives:</b>									
Fuel Gas System	1.02	MMscf CH4/heater/yr	100%		3,200	heaters	50%	3.26	122%
Pipe Stills									
Wastewater Treating	0.00798	lb VOC/bbl	100%	1.0%	13,246,238	b/d	5%	0.009	100%
Cooling Towers	0.01	lb VOC/bbl	100%	1.0%	13,246,238	b/d	5%	0.011	100%
<b>Venting:</b>									
Tanks	4.37E-07	ton CH4/bbl	100%		13,246,238	b/d	5%	0.100	100%
System Blowdowns	580	# HC/1000 bbc capacity	100%	1.0%	13,246,238	b/d	5%	0.665	100%
Process Vents									
PRVs									
<b>Combustion Sources:</b>									
Process Heaters:									
Atm. Distillation	0.30	lb THC/1000 bbl	100%	51.0%	13,246,238	b/d	5%	0.018	100%
Vacuum Distil.	0.30	lb THC/1000 bbl	100%	51.0%	6,084,486	b/d	5%	0.008	100%
Thermal Operations	0.50	lb THC/1000 bbl	100%	51.0%	1,644,395	b/d	5%	0.004	100%
Cat. Cracking	0.43	lb THC/1000 bbl	100%	51.0%	4,766,257	b/d	5%	0.009	100%
Cat. Reforming	0.60	lb THC/1000 bbl	100%	51.0%	3,352,139	b/d	5%	0.009	100%
Cat. Hydrocracking	0.60	lb THC/1000 bbl	100%	51.0%	1,024,133	b/d	5%	0.003	100%
Cat. Hydrotreating	0.18	lb THC/1000 bbl	100%	51.0%	2,059,005	b/d	5%	0.002	100%
Alkyl & Polymer.	0.54	lb THC/1000 bbl	100%	51.0%	6,099,481	b/d	5%	0.015	100%
Aromatics/Isomeration	1.05	lb THC/1000 bbl	100%	51.0%	953,940	b/d	5%	0.004	100%
Lube Processing	0.15	lb THC/1000 bbl	100%	51.0%	667,009	b/d	5%	0.000	100%
Asphalt	0.0	# HC/ton	100%		201,518	b/d	5%	0.000	100%
Hydrogen	60		100%		654,990	b/d	5%	0.174	100%
Coke	0.0	Included in Thermal Ops	100%					0.000	
Engines and Flares									
Engines	0.24	scf CH4/hp-hr	5%		20,334	MMhp-hr	100%	4.880	100%
Flares	0.0008	lb VOC/bbl	100%	1.0%	13,246,238	b/d	5%	0.001	100%
<b>Total</b>								9.172	69.3%

\* % Methane in VOC (volatile organic compounds) taken from AP-42 (Reference 28)  
 % Methane in HC (hydrocarbons) for system blowdowns is taken from AP-42  
 % Methane in THC (total hydrocarbons) calculated based on data from AP-42  
 % Methane in HC for asphalt calculated based on data from AP-42



**Table H-10**  
**1989 Methane Emission Estimate**  
**Petroleum - Production**

Emission Source	Emission Factor	Methane Emissions Units	Confidence Interval	Activity Factor	Activity Units	Confidence Interval	Emissions (Bscf)	Confidence Interval
Annual Production				7,612,000	bbl/d	5%		
% Heavy Crude (API<20°)				10.9%		100%		
Total Producing Oil Wells				603,365	wells	5%		
% Heavy Wells (API<20°)				7.2%		100%		
<b>Fugitives:</b>								
Offshore Platforms	2914	scfd CH4/platform	27%	1,092	platforms	10%	1.161	29%
Gulf of Mexico	1178	scfd CH4/platform	36%	22	platforms	10%	0.009	38%
Rest of US	0.83	scfd CH4/well	30%	43,322	wells	100%	0.013	109%
Oil Wellheads (heavy crude)	19.58	scfd CH4/well	30%	560,043	wells	100%	4.002	109%
Oil Wellheads (light crude)	0.85	scfd CH4/sep	30%	9,694	separators	78%	0.003	87%
Separators (heavy crude)	51.33	scfd CH4/sep	30%	117,601	separators	78%	2.203	87%
Separators (light crude)	59.74	scfd CH4/heater	30%	80,651	heater treaters	130%	1.759	139%
Heater/Treaters (light crude)	0.59	scfd CH4/heater	30%	16,098	headers	109%	0.003	118%
Headers (heavy crude)	202.78	scfd CH4/header	30%	48,800	headers	109%	3.612	118%
Headers (light crude)	34.4	scfd CH4/tank	30%	56,004	tanks	109%	0.703	118%
Tanks (light crude)								
Compressors (light crude)								
Small	46.14	scfd CH4/comp	100%	674	small g.l. comp.	91%	0.011	163%
Large	16,360	scfd CH4/comp	100%	2,023	large g.l. comp.	91%	12.083	163%
Sales Areas	40.55	scfd CH4/area	30%	4,443	sales areas	46%	0.066	57%
Pipelines	56.4	scfd CH4/mile	97%	70,000	miles	50%	1.441	119%
<b>Venting:</b>								
Oil Tanks	12.1	scf CH4/bbl	88%	7,612,000	bbl/d	5%	33.618	88%
Pneumatic Devices	345	scfd CH4/device	40%	121,966	pneumatics	78%	15.359	93%
CIPs	248	scfd CH4/pump	83%	129,241	CIPs	105%	11.699	160%
Vessel Blowdowns	78	scy CH4/vessel	266%	214,720	sep. and h.t.	70%	0.017	332%
Compressor Starts	8443	scy CH4/comp.	157%	2,925	gas lift comp.	81%	0.025	217%
Compressor Blowdowns	3774	scy CH4/comp.	147%	2,925	gas lift comp.	81%	0.011	205%
Completion Flaring	733	scfd CH4/completion	200%	580	completions	10%	0.155	201%
Well Workover	96	scf CH4/workover	200%	45,252	w.o./year	421%	0.004	962%
Casinghead Gas								
<b>Upsets:</b>								
ESD	256,888	scy CH4/plat	200%	1,114	platforms	10%	0.286	201%
PRV Lifts	34	scy CH4/PRV	252%	441,140	PRV	102%	0.015	375%
Well Blowout	250,000	scf CH4/blowout	200%	2.85	blowouts/yr	200%	0.001	490%
<b>Combustion Sources:</b>								
Gas Engines	0.24	scf CH4/HPHr	5%	18,427	MMHhp-hr	276%	4.422	277%
Burners	0.526	lb CH4/1000 gal	10%	10,120,000	bb/year	5%	0.005	11%
Drilling	0.052	ton CH4/well drilled	100%	580	expl. wells	10%	0.001	101%
Flares								
<b>Total</b>							92.69	48.5%

**Table H-11**  
**1989 Methane Emission Estimate**  
**Petroleum - Crude Transportation**

<b>Emission Source</b>	<b>Emission Factor</b>	<b>Methane Emissions Units</b>	<b>Confidence Interval</b>	<b>Activity Factor</b>	<b>Activity Units</b>	<b>Confidence Interval</b>	<b>Emissions (Bscf)</b>	<b>Confidence Interval</b>
<b>Fugitives:</b>								
Pump Stations	1.06	lb CH <sub>4</sub> /yr/mile	100%	55,664	miles	100%	0.0014	173%
Pipelines Metering	0.0	lb CH <sub>4</sub> /bbbl	10%	6.44E+09	bbbl/yr	5%	0.0000	11%
<b>Venting:</b>								
Tanks	4.37E-07	ton CH <sub>4</sub> /bbbl	100%	8686000000	bbbl/yr	4%	0.180	100%
<b>Loading</b>								
Truck	1.02E-05	ton CH <sub>4</sub> /bbbl	100%	6.86E+07	bbbl/yr	10%	0.033	101%
Marine	0.5	lb CH <sub>4</sub> /1000 gal crude	100%	9.09E+10	gal/yr	10%	1.078	101%
Rail Car	1.02E-05	ton CH <sub>4</sub> /bbbl	100%	1.98E+07	bbbl/yr	10%	0.010	101%
<b>Maintenance:</b>								
Pump Stations	1.56	lb CH <sub>4</sub> /y/station	100%	557	stations	100%	0.000	173%
<b>Combustion Sources:</b>								
Pump engine drivers	0.24	scf CH <sub>4</sub> /HPhr	5%					
Heaters								
<b>Total</b>							1.302	84.8%

**Table H-12**  
**1989 Methane Emission Estimate**  
**Petroleum - Refining**

Emission Source	Emission Factor	Methane Emissions Units	Confidence Interval	% Methane in THC*	Activity Factor	Activity Units	Confidence Interval	Emissions (Bscf)	Confidence Interval
<b>Fugitives:</b>									
Fuel Gas System	1.02	MMscf CH <sub>4</sub> /heater/yr	100%		3,200	heaters	50%	3.26	122%
Pipe Stills	0.00798	lb VOC/bbl	100%	1.0%	13,400,900	b/d	5%	0.009	100%
Wastewater Treating	0.01	lb VOC/bbl	100%	1.0%	13,400,900	b/d	5%	0.012	100%
Cooling Towers									
<b>Venting:</b>									
Tanks	4.37E-07	ton CH <sub>4</sub> /bbl	100%	1.0%	13,400,900	b/d	5%	0.101	100%
System Blowdowns	580	# HC/1000 bbc capacity	100%		13,400,900	b/d	5%	0.673	100%
Process Vents									
PRVs									
<b>Combustion Sources:</b>									
Process Heaters:									
Atm. Distillation	0.30	lb THC/1000 bbl	100%	51.0%	13,400,900	b/d	5%	0.018	100%
Vacuum Distil.	0.30	lb THC/1000 bbl	100%	51.0%	6,143,244	b/d	5%	0.008	100%
Thermal Operations	0.50	lb THC/1000 bbl	100%	51.0%	1,698,828	b/d	5%	0.004	100%
Cat. Cracking	0.43	lb THC/1000 bbl	100%	51.0%	4,902,489	b/d	5%	0.009	100%
Cat. Reforming	0.60	lb THC/1000 bbl	100%	51.0%	3,385,314	b/d	5%	0.009	100%
Cat. Hydrocracking	0.60	lb THC/1000 bbl	100%	51.0%	1,070,329	b/d	5%	0.003	100%
Cat. Hydrotreating	0.18	lb THC/1000 bbl	100%	51.0%	2,076,594	b/d	5%	0.002	100%
Cat. Hydrorefining	0.54	lb THC/1000 bbl	100%	51.0%	6,255,880	b/d	5%	0.015	100%
Alkyl & Polymer.	1.05	lb THC/1000 bbl	100%	51.0%	977,726	b/d	5%	0.005	100%
Aromatics/Isomeration	0.15	lb THC/1000 bbl	100%	51.0%	676,909	b/d	5%	0.000	100%
Lube Processing	0.0	# HC/ton	100%		207,013	b/d	5%	0.000	100%
Asphalt	60		100%		655,151	b/d	5%	0.174	100%
Hydrogen	0.0		100%					0.000	
Coke	0	Included in Thermal Ops	100%						
Engines and Flares									
Engines	0.24	scf CH <sub>4</sub> /hp-hr	5%		20,334	MMhp-hr	100%	4.880	100%
Flares	0.0008	lb VOC/bbl	100%	1.0%	13,400,900	b/d	5%	0.001	100%
<b>Total</b>								9.183	69.2%

\* % Methane in VOC (volatile organic compounds) taken from AP-42 (Reference 28)  
 % Methane in HC (hydrocarbons) for system blowdowns is taken from AP-42  
 % Methane in THC (total hydrocarbons) calculated based on data from AP-42  
 % Methane in HC for asphalt calculated based on data from AP-42

**Table H-13**  
**1990 Methane Emission Estimate**  
**Petroleum - Production**

Emission Source	Emission Factor	Methane Emissions Units	Confidence Interval	Activity Factor	Activity Units	Confidence Interval	Emissions (Bscf)	Confidence Interval
Annual Production				7,355,000	bb/d	5%		
% Heavy Crude (API<20°)				11.0%		100%		
Total Producing Oil Wells				602,439	wells	5%		
% Heavy Wells (API<20°)				7.2%		100%		
<b>Fugitives:</b>								
Offshore Platforms	2914	scfd CH4/platform	27%	1,092	platforms	10%	1.161	29%
Gulf of Mexico	1178	scfd CH4/platform	36%	22	platforms	10%	0.009	38%
Rest of US	0.83	scfd CH4/well	30%	43,556	wells	100%	0.013	109%
Oil Wellheads (heavy crude)	19.58	scfd CH4/well	30%	558,883	wells	100%	3.994	109%
Oil Wellheads (light crude)	0.85	scfd CH4/sep	30%	9,687	separators	78%	0.003	87%
Separators (heavy crude)	51.33	scfd CH4/sep	30%	116,936	separators	78%	2.191	87%
Separators (light crude)	59.74	scfd CH4/heater	30%	80,105	heater treaters	130%	1.747	139%
Heater/Treaters (light crude)	0.59	scfd CH4/header	30%	16,185	headers	109%	0.003	118%
Headers (heavy crude)	202.78	scfd CH4/header	30%	48,699	headers	109%	3.604	118%
Headers (light crude)	34.4	scfd CH4/tank	30%	55,888	tanks	109%	0.702	118%
Tanks (light crude)								
Compressors (light crude)								
Small	46.14	scfd CH4/comp	100%	670	small g.i. comp.	91%	0.011	163%
Large	16,360	scfd CH4/comp	100%	2,009	large g.i. comp.	91%	11.999	163%
Sales Areas	40.55	scfd CH4/area	30%	4,443	sales areas	46%	0.066	57%
Pipelines	56.4	scfd CH4/mile	97%	70,000	miles	50%	1.441	119%
<b>Venting:</b>								
Oil Tanks	12.1	scf CH4/bbl	88%	7,355,000	bb/d	5%	32.483	88%
Pneumatic Devices	345	scfd CH4/device	40%	121,299	pneumatics	78%	15.275	99%
CIPs	248	scfd CH4/pump	83%	129,042	CIPs	105%	11.681	160%
Vessel Blowdowns	78	scy CH4/vessel	266%	213,487	sep. and h.t.	70%	0.017	333%
Compressor Starts	8443	scy CH4/comp.	157%	2,906	gas lift comp.	81%	0.025	218%
Compressor Blowdowns	3774	scy CH4/comp.	147%	2,906	gas lift comp.	81%	0.011	206%
Completion Flaring	733	scfd CH4/completion	200%	620	completions	10%	0.166	201%
Well Workover	96	scf CH4/workover	200%	45,183	w.o./year	421%	0.004	962%
Casinghead Gas								
<b>Upsets:</b>								
ESD	256,888	scy CH4/plat	200%	1,114	platforms	10%	0.286	201%
PRV Lifts	34	scy CH4/PRV	252%	438,597	PRV	103%	0.015	375%
Well Blowout	250,000	scf CH4/blowout	200%	2.85	blowouts/yr	200%	0.001	490%
<b>Combustion Sources:</b>								
Gas Engines	0.24	scf CH4/HPHr	5%	18,306	MMhp-hr	277%	4.393	277%
Burners	0.526	lb CH4/1000 gal	10%	8,773,000	bb/yr	5%	0.005	11%
Drilling	0.052	ton CH4/well drilled	100%	620	expl. wells	10%	0.002	101%
Flares								
<b>Total</b>							91.31	48.4%

**Table H-14  
1990 Methane Emission Estimate  
Petroleum - Crude Transportation**

<b>Emission Source</b>	<b>Emission Factor</b>	<b>Methane Emissions Units</b>	<b>Confidence Interval</b>	<b>Activity Factor</b>	<b>Activity Units</b>	<b>Confidence Interval</b>	<b>Emissions (Bscf)</b>	<b>Confidence Interval</b>
<b>Fugitives:</b>								
Pump Stations	1.06	lb CH4/yr/mile	100%	55,504	miles	100%	0.0014	173%
Pipelines	0.0	lb CH4/bbl	10%	6.56E+09	bbl/yr	5%	0.0000	11%
Metering								
<b>Venting:</b>								
Tanks	4.37E-07	ton CH4/bbl	100%	8767000000	bbl/yr	4%	0.182	100%
<b>Loading</b>								
Truck	1.02E-05	ton CH4/bbl	100%	6.47E+07	bbl/yr	10%	0.031	101%
Marine	0.5	lb CH4/1000 gal crude	100%	8.91E+10	gal/yr	10%	1.056	101%
Rail Car	1.02E-05	ton CH4/bbl	100%	2.01E+07	bbl/yr	10%	0.010	101%
<b>Maintenance:</b>								
Pump Stations	1.56	lb CH4/y/station	100%	555	stations	100%	0.000	173%
<b>Combustion Sources:</b>								
Pump engine drivers	0.24	scf CH4/HPHr	5%					
Heaters								
<b>Total</b>							1.280	84.6%

**Table H-15**  
**1990 Methane Emission Estimate**  
**Petroleum - Refining**

Emission Source	Emission Factor	Methane Emissions Units	Confidence Interval	% Methane in THC*	Activity Factor	Activity Units	Confidence Interval	Emissions (Bscf)	Confidence Interval
<b>Fugitives:</b>									
Fuel Gas System	1.02	MMscf CH4/heater/yr	100%		3,200	heaters	50%	3.26	122%
Pipe Stills	0.00798	lb VOC/bbl	100%	1.0%	13,409,414	b/d	5%	0.009	100%
Wastewater Treating	0.01	lb VOC/bbl	100%	1.0%	13,409,414	b/d	5%	0.012	100%
<b>Venting:</b>									
Tanks	4.37E-07	ton CH4/bbl	100%		13,409,414	b/d	5%	0.101	100%
System Blowdowns	580	# HC/1000 bbc capacity	100%	1.0%	13,409,414	b/d	5%	0.673	100%
Process Vents									
PRVs									
<b>Combustion Sources:</b>									
Process Heaters:									
Atm. Distillation	0.30	lb THC/1000 bbl	100%	51.0%	13,409,414	b/d	5%	0.018	100%
Vacuum Distil.	0.30	lb THC/1000 bbl	100%	51.0%	6,121,692	b/d	5%	0.008	100%
Thermal Operations	0.50	lb THC/1000 bbl	100%	51.0%	1,747,240	b/d	5%	0.004	100%
Cat. Cracking	0.43	lb THC/1000 bbl	100%	51.0%	4,945,330	b/d	5%	0.009	100%
Cat. Reforming	0.60	lb THC/1000 bbl	100%	51.0%	3,379,887	b/d	5%	0.009	100%
Cat. Hydrocracking	0.60	lb THC/1000 bbl	100%	51.0%	1,092,222	b/d	5%	0.003	100%
Cat. Hydrorefining	0.18	lb THC/1000 bbl	100%	51.0%	2,119,749	b/d	5%	0.002	100%
Cat. Hydrotreating	0.54	lb THC/1000 bbl	100%	51.0%	6,298,044	b/d	5%	0.015	100%
Alkyl & Polymer.	1.05	lb THC/1000 bbl	100%	51.0%	1,010,171	b/d	5%	0.005	100%
Aromatics/Isomeration	0.15	lb THC/1000 bbl	100%	51.0%	724,526	b/d	5%	0.000	100%
Lube Processing	0.0	# HC/ton	100%	51.0%	194,649	b/d	5%	0.000	100%
Asphalt	60		100%		648,607	b/d	5%	0.172	100%
Hydrogen	0.0		100%					0.000	
Coke	0	Included in Thermal Ops	100%						
Engines and Flares									
Engines	0.24	scf CH4/hp-hr	5%		20,334	MMhp-hr	100%	4.880	100%
Flares	0.0008	lb VOC/bbl	100%	1.0%	13,409,414	b/d	5%	0.001	100%
<b>Total</b>								9.181	69.2%

\* % Methane in VOC (volatile organic compounds) taken from AP-42 (Reference 28)  
 % Methane in HC (hydrocarbons) for system blowdowns is taken from AP-42  
 % Methane in THC (total hydrocarbons) calculated based on data from AP-42  
 % Methane in HC for asphalt calculated based on data from AP-42

**Table H-16**  
**1991 Methane Emission Estimate**  
**Petroleum - Production**

Emission Source	Emission Factor	Methane Emissions Units	Confidence Interval	Activity Factor	Activity Units	Confidence Interval	Emissions (Bscf)	Confidence Interval
Annual Production				7,417,000	bb/d	5%		
% Heavy Crude (API<20°)				10.8%		100%		
Total Producing Oil Wells				613,810	wells	5%		
% Heavy Wells (API<20°)				7.2%		100%		
<b>Fugitives:</b>								
Offshore Platforms	2914	scfd CH4/platform	27%	1,092	platforms	10%	1.161	29%
Gulf of Mexico	1178	scfd CH4/platform	36%	22	platforms	10%	0.009	38%
Rest of US	0.83	scfd CH4/well	30%	44,072	wells	100%	0.013	109%
Oil Wellheads (heavy crude)	19.58	scfd CH4/well	30%	569,738	wells	100%	4.072	109%
Oil Wellheads (light crude)	0.85	scfd CH4/well	30%	9,776	separators	78%	0.003	87%
Separators (heavy crude)	51.33	scfd CH4/sep	30%	119,088	separators	78%	2.231	87%
Separators (light crude)	59.74	scfd CH4/sep	30%	81,554	heater treaters	130%	1.778	139%
Heater/Treaters (light crude)	0.59	scfd CH4/header	30%	16,376	headers	109%	0.004	118%
Heater/Treaters (heavy crude)	202.78	scfd CH4/header	30%	49,645	headers	109%	3.674	118%
Headers (light crude)	34.4	scfd CH4/tank	30%	56,974	tanks	109%	0.715	118%
Headers (heavy crude)								
Tanks (light crude)								
Tanks (heavy crude)								
Compressors (light crude)								
Small	46.14	scfd CH4/comp	100%	682	small g.l. comp.	91%	0.011	163%
Large	16,360	scfd CH4/comp	100%	2,046	large g.l. comp.	91%	12.216	163%
Sales Areas	40.55	scfd CH4/area	30%	4,443	sales areas	46%	0.066	57%
Pipelines	56.4	scfd CH4/mile	97%	70,000	miles	50%	1.441	119%
<b>Venting:</b>								
Oil Tanks	12.1	scf CH4/bbl	88%	7,417,000	bb/d	5%	32.757	88%
Pneumatic Devices	345	scfd CH4/device	40%	123,438	pneumatics	78%	15.544	93%
CIPs	248	scfd CH4/pump	83%	131,478	CIPs	105%	11.901	160%
Vessel Blowdowns	78	scfy CH4/vessel	266%	217,234	sep. and h.t.	70%	0.017	333%
Compressor Starts	8443	scfy CH4/comp.	157%	2,956	gas lift comp.	81%	0.025	218%
Compressor Blowdowns	3774	scfy CH4/comp.	147%	2,956	gas lift comp.	81%	0.011	206%
Completion Flaring	733	scfd CH4/completion	200%	550	completions	10%	0.147	201%
Well Workover	96	scf CH4/workover	200%	46,036	w.o./year	421%	0.004	962%
Casinghead Gas								
<b>Upsets:</b>								
ESD	256,888	scfy CH4/plat	200%	1,114	platforms	10%	0.286	201%
PRV Lifts	34	scfy CH4/PRV	252%	446,291	PRV	103%	0.015	375%
Well Blowout	250,000	scf CH4/blowout	200%	2.85	blowouts/yr	200%	0.001	490%
<b>Combustion Sources:</b>								
Gas Engines	0.24	scf CH4/HPhr	5%	18,622	MMhp-hr	277%	4.469	277%
Burners	0.526	lb CH4/1000 gal	10%	6,715,000	bb/year	5%	0.004	11%
Drilling	0.052	ton CH4/well drilled	100%	550	expl. wells	10%	0.001	101%
Flares								
<b>Total</b>							92.58	48.4%

**Table H-17**  
**1991 Methane Emission Estimate**  
**Petroleum - Crude Transportation**

<b>Emission Source</b>	<b>Emission Factor</b>	<b>Methane Emissions Units</b>	<b>Confidence Interval</b>	<b>Activity Factor</b>	<b>Activity Units</b>	<b>Confidence Interval</b>	<b>Emissions (Bscf)</b>	<b>Confidence Interval</b>
<b>Fugitives:</b>								
Pump Stations	1.06	lb CH4/yr/mile	100%	59,034	miles	100%	0.0015	173%
Pipelines	0.0	lb CH4/bbl	10%	6.69E+09	bbl/yr	5%	0.0000	11%
Metering								
<b>Venting:</b>								
Tanks	4.37E-07	ton CH4/bbl	100%	8914000000	bbl/yr	4%	0.185	100%
<b>Loading</b>								
Truck	1.02E-05	ton CH4/bbl	100%	6.72E+07	bbl/yr	10%	0.033	101%
Marine	0.5	lb CH4/1000 gal crude	100%	9.00E+10	gal/yr	10%	1.067	101%
Rail Car	1.02E-05	ton CH4/bbl	100%	1.91E+07	bbl/yr	10%	0.009	101%
<b>Maintenance:</b>								
Pump Stations	1.56	lb CH4/y/station	100%	590	stations	100%	0.000	173%
<b>Combustion Sources:</b>								
Pump engine drivers	0.24	scf CH4/HPhr	5%					
Heaters								
<b>Total</b>							1.296	84.4%



**Table H-18  
1991 Methane Emission Estimate  
Petroleum - Refining**

<b>Emission Source</b>	<b>Emission Factor</b>	<b>Methane Emissions Units</b>	<b>Confidence Interval</b>	<b>% Methane in THC*</b>	<b>Activity Factor</b>	<b>Activity Units</b>	<b>Confidence Interval</b>	<b>Emissions (Bscf)</b>	<b>Confidence Interval</b>
<b>Fugitives:</b>									
Fuel Gas System	1.02	MMscf CH4/heater/yr	100%		3,200	heaters	50%	3.26	122%
Pipe Stills									
Wastewater Treating	0.00798	lb VOC/bbl	100%	1.0%	12,486,545	b/d	5%	0.009	100%
Cooling Towers	0.01	lb VOC/bbl	100%	1.0%	12,486,545	b/d	5%	0.011	100%
<b>Venting:</b>									
Tanks	4.37E-07	ton CH4/bbl	100%		12,486,545	b/d	5%	0.094	100%
System Blowdowns	580	# HC/1000 bbc capacity	100%	1.0%	12,486,545	b/d	5%	0.627	100%
Process Vents									
<b>Upsets</b>									
PRVs									
<b>Combustion Sources:</b>									
Process Heaters:									
Atm. Distillation	0.30	lb THC/1000 bbl	100%	51.0%	12,486,545	b/d	5%	0.017	100%
Vacuum Distil.	0.30	lb THC/1000 bbl	100%	51.0%	5,748,914	b/d	5%	0.008	100%
Thermal Operations	0.50	lb THC/1000 bbl	100%	51.0%	1,644,146	b/d	5%	0.004	100%
Cat. Cracking	0.43	lb THC/1000 bbl	100%	51.0%	4,484,353	b/d	5%	0.008	100%
Cat. Reforming	0.60	lb THC/1000 bbl	100%	51.0%	3,208,753	b/d	5%	0.008	100%
Cat. Hydrocracking	0.60	lb THC/1000 bbl	100%	51.0%	1,071,567	b/d	5%	0.003	100%
Cat. Hydrotreating	0.18	lb THC/1000 bbl	100%	51.0%	1,985,098	b/d	5%	0.002	100%
Cat. Hydrotreating	0.54	lb THC/1000 bbl	100%	51.0%	5,986,416	b/d	5%	0.014	100%
Alkyl & Polymer.	1.05	lb THC/1000 bbl	100%	51.0%	971,827	b/d	5%	0.005	100%
Aromatics/Isomeration	0.15	lb THC/1000 bbl	100%	51.0%	690,707	b/d	5%	0.000	100%
Lube Processing	0.0	# HC/ton	100%	51.0%	176,456	b/d	5%	0.000	100%
Asphalt	60		100%		627,123	b/d		0.000	
Hydrogen	0.0		100%						
Coke	0	Included in Thermal Ops	100%						
Engines and Flares									
Engines	0.24	scf CH4/hp-hr	5%		20,334	MMhp-hr	100%	4.880	100%
Flares	0.0008	lb VOC/bbl	100%	1.0%	12,486,545	b/d	5%	0.001	100%
<b>Total</b>								9.117	69.7%

\* % Methane in VOC (volatile organic compounds) taken from AP-42 (Reference 28)  
 % Methane in HC (hydrocarbons) for system blowdowns is taken from AP-42  
 % Methane in THC (total hydrocarbons) calculated based on data from AP-42  
 % Methane in HC for asphalt calculated based on data from AP-42

**Table H-19**  
**1992 Methane Emission Estimate**  
**Petroleum - Production**

<b>Emission Source</b>	<b>Emission Factor</b>	<b>Methane Emissions Units</b>	<b>Confidence Interval</b>	<b>Activity Factor</b>	<b>Activity Units</b>	<b>Confidence Interval</b>	<b>Emissions (Bscf)</b>	<b>Confidence Interval</b>
Annual Production				7,171,000	bbl/d	5%		
% Heavy Crude (API<20°)				11.9%		100%		
Total Producing Oil Wells				594,189	wells	5%		
% Heavy Wells (API<20°)				7.1%		100%		
<b>Fugitives:</b>								
Offshore Platforms	2914	scfd CH4/platform	27%	1,092	platforms	10%	1.161	29%
Gulf of Mexico	1178	scfd CH4/platform	36%	22	platforms	10%	0.009	38%
Rest of US	0.83	scfd CH4/well	30%	42,247	wells	100%	0.013	109%
Oil Wellheads (heavy crude)	19.58	scfd CH4/well	30%	551,942	wells	100%	3.945	109%
Oil Wellheads (light crude)	0.85	scfd CH4/sep	30%	9,533	separators	78%	0.003	87%
Separators (heavy crude)	51.33	scfd CH4/sep	30%	115,195	separators	78%	2.158	87%
Separators (light crude)	59.74	scfd CH4/heater	30%	78,850	heater treaters	130%	1.719	139%
Heater/Treaters (light crude)	0.59	scfd CH4/header	30%	15,698	headers	109%	0.003	118%
Headers (heavy crude)	202.78	scfd CH4/header	30%	48,095	headers	109%	3.560	118%
Headers (light crude)	34.4	scfd CH4/tank	30%	55,194	tanks	109%	0.693	118%
Tanks (light crude)								
Compressors (light crude)								
Small	46.14	scfd CH4/comp	100%	659	small g.l. comp.	91%	0.011	163%
Large	16,360	scfd CH4/comp	100%	1,978	large g.l. comp.	91%	11.810	163%
Sales Areas	40.55	scfd CH4/area	30%	4,443	sales areas	46%	0.066	57%
Pipelines	56.4	scfd CH4/mile	97%	70,000	miles	50%	1.441	119%
<b>Venting:</b>								
Oil Tanks	12.1	scf CH4/bbl	88%	7,171,000	bbl/d	5%	31.671	88%
Pneumatic Devices	345	scfd CH4/device	40%	119,475	pneumatics	78%	15.045	93%
CIPs	248	scfd CH4/pump	83%	127,275	CIPs	105%	11.521	160%
Vessel Blowdowns	78	scy CH4/vessel	266%	210,257	sep. and h.t.	70%	0.016	333%
Compressor Starts	8443	scy CH4/comp.	157%	2,861	gas lift comp.	81%	0.024	218%
Compressor Blowdowns	3774	scy CH4/comp.	147%	2,861	gas lift comp.	81%	0.011	206%
Completion Flaring	733	scfd CH4/completion	200%	450	completions	10%	0.120	201%
Well Workover	96	scf CH4/workover	200%	44,564	w.o./year	421%	0.004	962%
Casinghead Gas								
<b>Upsets:</b>								
ESD	256,888	scy CH4/plat	200%	1,114	platforms	10%	0.286	201%
PRV Lifts	34	scy CH4/PRV	252%	431,957	PRV	103%	0.015	376%
Well Blowout	250,000	scf CH4/blowout	200%	2.85	blowouts/yr	200%	0.001	490%
<b>Combustion Sources:</b>								
Gas Engines	0.24	scf CH4/HPHr	5%	18,023	MMhp-hr	277%	4.326	277%
Burners	0.526	lb CH4/1000 gal	10%	4,718,000	bbl/year	5%	0.002	11%
Drilling	0.052	ton CH4/well drilled	100%	450	expl. wells	10%	0.001	101%
Flares								
<b>Total</b>							<b>89.64</b>	<b>48.4%</b>

**Table H-20  
1992 Methane Emission Estimate  
Petroleum - Crude Transportation**

<b>Emission Source</b>	<b>Emission Factor</b>	<b>Methane Emissions Units</b>	<b>Confidence Interval</b>	<b>Activity Factor</b>	<b>Activity Units</b>	<b>Confidence Interval</b>	<b>Emissions (Bscf)</b>	<b>Confidence Interval</b>
<b>Fugitives:</b>								
Pump Stations	1.06	lb CH4/yr/mile	100%	54,675	miles	100%	0.0014	173%
Pipelines	0.0	lb CH4/bbl	10%	6.54E+09	bbl/yr	5%	0.0000	11%
Metering								
<b>Venting:</b>								
Tanks	4.37E-07	ton CH4/bbl	100%	8825000000	bbl/yr	4%	0.183	100%
<b>Loading</b>								
Truck	1.02E-05	ton CH4/bbl	100%	7.19E+07	bbl/yr	10%	0.035	101%
Marine	0.5	lb CH4/1000 gal crude	100%	9.26E+10	gal/yr	10%	1.098	101%
Rail Car	1.02E-05	ton CH4/bbl	100%	7.52E+06	bbl/yr	10%	0.004	101%
<b>Maintenance:</b>								
Pump Stations	1.56	lb CH4/y/station	100%	547	stations	100%	0.000	173%
<b>Combustion Sources:</b>								
Pump engine drivers	0.24	scf CH4/HPhr	5%					
Heaters								
<b>Total</b>							1.321	85.1%

**Table H-21**  
**1992 Methane Emission Estimate**  
**Petroleum - Refining**

Emission Source	Emission Factor	Methane Emissions Units	Confidence Interval	% Methane in THC*	Activity Factor	Activity Units	Confidence Interval	Emissions (Bscf)	Confidence Interval
<b>Fugitives:</b>									
Fuel Gas System	1.02	MMscf CH <sub>4</sub> /heater/yr	100%		3,200	heaters		3.26	122%
Pipe Stills									
Wastewater Treating	0.00798	lb VOC/bbl	100%	1.0%	13,410,527	b/d		0.009	100%
Cooling Towers	0.01	lb VOC/bbl	100%	1.0%	13,410,527	b/d		0.012	100%
<b>Venting:</b>									
Tanks	4.37E-07	ton CH <sub>4</sub> /bbl	100%		13,410,527	b/d		0.101	100%
System Blowdowns	580	# HC/1000 bbc capacity	100%	1.0%	13,410,527	b/d		0.673	100%
Process Vents									
PRVs									
<b>Combustion Sources:</b>									
Process Heaters:									
Atm. Distillation	0.30	lb THC/1000 bbl	100%	51.0%	13,410,527	b/d		0.018	100%
Vacuum Distil.	0.30	lb THC/1000 bbl	100%	51.0%	5,849,509	b/d		0.008	100%
Thermal Operations	0.50	lb THC/1000 bbl	100%	51.0%	1,582,073	b/d		0.004	100%
Cat. Cracking	0.43	lb THC/1000 bbl	100%	51.0%	4,585,047	b/d		0.009	100%
Cat. Reforming	0.60	lb THC/1000 bbl	100%	51.0%	3,171,605	b/d		0.008	100%
Cat. Hydrocracking	0.60	lb THC/1000 bbl	100%	51.0%	1,083,645	b/d		0.003	100%
Cat. Hydrotreating	0.18	lb THC/1000 bbl	100%	51.0%	1,880,137	b/d		0.001	100%
Cat. Hydrotreating	0.54	lb THC/1000 bbl	100%	51.0%	6,208,001	b/d		0.015	100%
Alkyl & Polymer.	1.05	lb THC/1000 bbl	100%	51.0%	982,173	b/d		0.005	100%
Aromatics/Isomeration	0.15	lb THC/1000 bbl	100%	51.0%	701,466	b/d		0.000	100%
Lube Processing	0.0	# HC/ton	100%	51.0%	170,852	b/d		0.000	100%
Asphalt	60		100%		662,633	b/d		0.176	100%
Hydrogen	0.0		100%					0.000	
Coke	0	Included in Thermal Ops	100%						
Engines and Flares									
Engines	0.24	scf CH <sub>4</sub> /hp-hr	5%		20,334	MMhp-hr		4.880	100%
Flares	0.0008	lb VOC/bbl	100%	1.0%	13,410,527	b/d		0.001	100%
<b>Total</b>								<b>9.183</b>	<b>69.2%</b>

\* % Methane in VOC (volatile organic compounds) taken from AP-42 (Reference 28)  
 % Methane in HC (hydrocarbons) for system blowdowns is taken from AP-42  
 % Methane in THC (total hydrocarbons) calculated based on data from AP-42  
 % Methane in HC for asphalt calculated based on data from AP-42