



U.S. Department
of Transportation
**National Highway
Traffic Safety
Administration**



People Saving People
<http://www.nhtsa.dot.gov>



PB99-143992

DOT HS 808 875

January 1999

Final Report

NHTSA Light Vehicle Antilock Brake System Research Program Task 4: *A Test Track Study of Light Vehicle ABS Performance Over a Broad Range of Surfaces and Maneuvers*

This document is available to the public from the National Technical Information Service, Springfield, Virginia 22161.

This publication is distributed by the U.S. Department of Transportation, National Highway Traffic Safety Administration, in the interest of information exchange. The opinions, findings and conclusions expressed in this publication are those of the author(s) and not necessarily those of the Department of Transportation or the National Highway Traffic Safety Administration. The United States Government assumes no liability for its contents or use thereof. If trade or manufacturer's name or products are mentioned, it is because they are considered essential to the object of the publication and should not be construed as an endorsement. The United States Government does not endorse products or manufacturers.

Technical Report Documentation Page

1. Report No. DOT HS 808 875		2. Government Accession No.		3. Recipient's Catalog No.	
4. Title and Subtitle NHTSA Light Vehicle Antilock Brake System Research Program Task 4: A Test Track Study of Light Vehicle ABS Performance Over a Broad Range of Surfaces and Maneuvers		5. Report Date January, 1999		6. Performing Organization Code NHTSA/NRD-22	
		8. Performing Organization Report No.		 PB99-143992	
		7. Author(s) Garrick J. Forkenbrock, Transportation Research Center Inc. Mark Flick, Radlinski & Associates Inc. W. Riley Garrott, NHTSA			
9. Performing Organization Name and Address National Highway Traffic Safety Administration Vehicle Research and Test Center P.O. Box 37 East Liberty, OH 43319		10. Work Unit No. (TRAIS)		11. Contract or Grant No.	
		12. Sponsoring Agency Name and Address National Highway Traffic Safety Administration 400 Seventh Street, S.W. Washington, D.C. 20590		13. Type of Report and Period Covered Final Report	
15. Supplementary Notes					
16. Abstract Numerous crash data statistical analyses conducted over the past few years suggest that, for automobiles, the introduction of four-wheel antilock brake systems (ABS) has produced net safety benefits much lower than originally expected. The studies indicate the apparent increase in single-vehicle crashes involving passenger cars equipped with four-wheel ABS almost completely offsets the safety advantage such vehicles have over their conventionally-braked counterparts. The braking performance of nine high production passenger vehicles was evaluated in eighteen stopping situations. These situations were comprised of various road surfaces, driver steering actions, and vehicle speeds. Testing was performed with lightly and heavily laden vehicles, with the ABS active and disabled, and used two brake pedal application techniques. The selected vehicles included at least one ABS from each of the eight current, major, ABS manufacturers. This study found that for most stopping maneuvers on most surfaces, ABS-assisted full pedal brake application stops were shorter than those made with the ABS disabled. The one systematic exception was on loose gravel where stopping distances increased by an average of 27.2 percent overall. Additionally, the vehicular stability during testing was almost always superior with the assistance of ABS. For the cases in which instability was observed, ABS was not deemed responsible for its occurrence. Based on results to date, the authors of this study believe ABS braking performance deficiencies are not responsible for the apparent increase in ABS-equipped, single-vehicle, run-off-the-road crashes.					
17. Key Words Antilock Brake Systems, ABS, Light Vehicle Braking, Light Vehicle Testing, Collision Avoidance Systems			18. Distribution Statement Document is available to the public from the National Technical Information Service Springfield, VA 22161		
19. Security Classif. (of this report) Unclassified		20. Security Classif. (of this page) Unclassified		21. No. of Pages	
				22. Price	

Table of Contents

List of Figures.....	i
List of Tables.....	iii
Abstract.....	iv
1.0 INTRODUCTION.....	1
2.0 BACKGROUND AND STUDY OBJECTIVES	5
3.0 TEST PROCEDURE.....	7
3.1 Test Vehicles.....	7
3.2 Instrumentation.....	9
3.3 Loading.....	10
3.4 Road Transducer Plates.....	10
3.5 Test Matrix.....	11
3.6 Test Surfaces.....	11
3.7 Surface Friction Measurements.....	13
3.8 Maneuvers.....	14
3.9 Stopping Distance Correction.....	16
3.10 Brake Applications.....	17
4.0 ROAD TRANSDUCER PLATE RESULTS	19
5.0 TEST TRACK RESULTS.....	23
5.1 Comments on the Reporting of ABS Performance Results.....	23
5.2 Straight Line Stops on Uniform Coefficient Surfaces.....	24
5.3 Straight Line Stops on Off-road Surfaces.....	25
5.3.1 Grass.....	25
5.3.2 Loose Gravel.....	26
5.4 Transition Surface Braking.....	27
5.5 ABS Test Course Braking.....	28
5.6 Split-mu Surface Braking.....	29

5.7 Braking in a Curve.....	31
5.8 J-turn Stopping Maneuver.....	32
5.9 Single Lane Change onto a Split-mu Surface.....	33
6.0 HUMAN FACTORS CONSIDERATIONS	40
7.0 CONCLUSION.....	41
8.0 ACKNOWLEDGMENTS	45
9.0 REFERENCES.....	46
Appendix.....	48

List of Figures

Figure 1. ABS Test Pad #2.....	13
Figure 2. ABS Test Pad #3.....	13
Figure 3. Perpendicular transition.....	14
Figure 4. Offset transition.....	14
Figure 5. Braking in a curve.....	15
Figure 6. J-turn maneuver. Approach is tangent to a 45.7 m (150 ft) radius curve.....	15
Figure 7. Single lane change maneuver.....	16
Figure 8. Brake distribution as a function of vehicle deceleration.....	20
Figure 9. Braking efficiency as a function of surface coefficient of friction.....	21
Figure 10. Straight line stopping distances observed on dry concrete. Test vehicles were fully laden to their respective GVWRs.....	24
Figure 11. Straight line stopping distances observed on wet Jennite. Test vehicles were fully laden to their respective GVWRs.....	24
Figure 12. Straight line stopping distances observed on grass. Test vehicles were fully laden to their respective GVWRs. Note: the grass was very wet when the braking performance of vehicle “T” was evaluated.....	26
Figure 13. Straight line stopping distances observed on gravel. Test vehicles were fully laden to their respective GVWRs. Note: the gravel was wet when the braking performance of vehicle “T” was evaluated.....	27
Figure 14. Straight line stopping distances observed on the wet asphalt/wet Jennite transition surface. Test vehicles were fully laden to their respective GVWRs.....	28
Figure 15. Straight line stopping distances observed on ABS Test Pad #3 (wet). Test vehicles were fully laden to their respective GVWRs. Vehicle “T” braking performance was not evaluated.....	29

Figure 16. Straight line stopping distances observed on the wet asphalt/wet epoxy split-mu surface. Test vehicles were fully laden to their respective GVWRs. Note: the epoxy surface was reconditioned prior to the brake performance evaluation of vehicles “H” and “T”..... 30

Figure 17. Stopping distances observed on the 152.4 m (500 ft) wet Jennite curve. Test vehicles were fully laden to their respective GVWRs..... 32

Figure 18. Stopping distances observed on the 91.4 m (300 ft) wet Jennite curve. Test vehicles were fully laden to their respective GVWRs..... 32

Figure 19. J-Turn stopping distances observed on dry asphalt. Test vehicles were fully laden to their respective GVWRs..... 33

Figure 20. Wet asphalt to wet asphalt/wet epoxy split-mu single lane change stopping distances. Test vehicles were fully laden to their respective GVWRs. Note: the epoxy surface was reconditioned prior to the brake performance evaluation of vehicles “H” and “T”..... 35

Figure 21. Single lane change driver inputs for test vehicle “C”. The vehicle was lightly laden..... 38

List of Tables

Table 1. Test Vehicle ABS Configuration.....	8
Table 2. Instrumentation.....	9
Table 3. Light Vehicle ABS Test Matrix.....	12
Table 4. Test Vehicle Braking Efficiency (%) as a Function of Surface Coefficient of Friction.....	22
Table 5. Single Lane Change Results.....	37
Table 6. ABS Performance Summary.....	41

ABSTRACT

A Test Track Study of Light Vehicle Antilock Brake System Performance Over a Broad Range of Surfaces and Maneuvers was conducted to compare the braking performance of vehicles equipped with present-day antilock brake systems (ABS) with the performance of the same vehicle without ABS (simulated conventional brakes) over a large range of driving conditions. The motivation for this work was to attempt to find situations and/or conditions in which many ABS-equipped vehicles did not perform as well as their non-ABS counterparts, not to compare vehicles or antilock brake systems to one another.

The braking performance of nine high production passenger vehicles was evaluated in eighteen stopping situations. These situations were comprised of various road surfaces, driver steering actions, and vehicle speeds. Testing was performed with lightly and heavily laden vehicles, with the ABS active and disabled, and used two brake pedal application techniques. The selected vehicles included at least one ABS from each of the eight current, major, ABS manufacturers.

This study found that for most stopping maneuvers on most surfaces, ABS-assisted full pedal brake application stops were shorter than those made with the ABS disabled. The one systematic exception was on loose gravel where stopping distances increased by an average of 27.2 percent overall. Additionally, vehicular stability during these maneuvers was almost always superior with the assistance of ABS. For the cases in which instability was observed, ABS was not deemed responsible or its occurrence.

A TEST TRACK STUDY OF LIGHT VEHICLE ANTILOCK BRAKE SYSTEM PERFORMANCE OVER A BROAD RANGE OF SURFACES AND MANEUVERS

1.0 INTRODUCTION

Antilock brake systems (ABS) first appeared in the U.S. during the late 1960's. By the late-80's four-wheel ABS had become standard equipment on a limited number of sport and luxury-oriented automobiles and light trucks. In recent years, ABS has become more common and is now standard equipment on many high production passenger cars and light trucks. According to ITT Automotive, 62 percent of 1996 model year vehicles were equipped with ABS [1].

The principle reason for equipping passenger cars and light trucks with ABS is to increase safety. Years of watching the enhanced lateral stability and improved stopping performance of vehicles equipped with ABS on the test track initially convinced brake experts that the widespread introduction of ABS should significantly reduce the number of crashes, and the resulting injuries and fatalities, that occur on our nation's highways.

To determine whether the experts' belief that the introduction of ABS would increase safety was indeed true, a number of statistical analyses of crash data have been performed over the past several years. These analyses suggest that, for automobiles, the introduction of ABS has produced net safety benefits much lower than originally expected for ABS-equipped vehicles [2,3,4,5]. For example, Kahane found that while the involvement of ABS-equipped automobiles in fatal multi-vehicle crashes on wet roads was reduced by 24 percent, fatal single vehicle crashes increased by 28 percent [5]. This increase in single-vehicle crashes almost completely offsets the safety advantage an ABS-equipped automobile has over its conventionally-braked counterpart. Similar results were found in the other automobile crash database studies. Note that the anticipated safety benefits due to ABS *were* seen in light truck (rear wheel ABS only) crash data studies.

To learn why the crash data studies did not find the anticipated increase in safety for ABS-equipped automobiles, the National Highway Traffic Safety Administration (NHTSA) developed

its Light Vehicle ABS Research Program. This comprehensive program attempts, in a series of tasks, to examine all plausible reasons why the crash data studies do not show that ABS has improved automobile safety. NHTSA's Motor Vehicle Safety Research Advisory Committee's (MVSRAAC) ABS Working Group, comprised of government and industry participants, commented on, and approved of, the research program's test plan.

Task 1 of NHTSA's Light Vehicle ABS Research Program involves performing a new crash data study of the effect on safety of adding four-wheel ABS to automobiles. This study differs from those previously conducted [2,3,4,5] in that it focuses on newer vehicles and antilock brake systems and includes some methodological improvements. This study will endeavor to address whether whatever problem may have caused the apparent increase in single-vehicle crashes for ABS-equipped automobiles still exists with the introduction of newer generation ABS hardware.

Task 2 of this program is a national survey to determine driver's knowledge and expectations about ABS. This information will be used to determine whether the apparent increase in single-vehicle crashes for automobiles is due to drivers' misunderstanding of ABS functionality.

Task 3 will examine selected single-vehicle crash reports that have been collected by the National Automotive Sampling System (NASS). The goal of this work is to determine what differences may exist in the characteristics of single-vehicle crashes incurred by ABS-equipped versus non-ABS-equipped automobiles using NASS Crashworthiness Data System (CDS) cases.

Task 4 (the subject of this report) measures the braking performance of a group of current production ABS-equipped vehicles over a broad range of surfaces and maneuvers. While ABS stopping performance has been measured by many groups over many years, there is a possibility that poor performance on some unusual surface or during some maneuver may have been overlooked. If such could be found, this might explain the apparent increase in single-vehicle crashes of ABS-equipped automobiles.

Task 5 examines the hypothesis that the apparent increase in single-vehicle crashes with ABS-equipped vehicles is due to driver “oversteering” in crash-imminent situations. The idea is that in a crash imminent situation, a driver’s first action is to push very hard on the brake pedal. Oversteering occurs when the driver, possibly believing that the hard braking input will be insufficient to avoid the upcoming obstacle (such as another vehicle) rapidly turns the steering wheel by a large amount. For conventionally braked or rear-wheel ABS only vehicles, this oversteering has little effect, since the initial driver brake pedal activation locks the vehicle’s front wheels. However, for a vehicle equipped with four-wheel ABS (where the ABS minimizes front wheel lockup and allows the driver to maintain steering capability), the oversteering may result in the vehicle missing the upcoming obstacle, going off of the roadway, and being involved in a single-vehicle crash.

Task 5 is divided into multiple subtasks to examine driver crash avoidance behavior with and without ABS. This task seeks to assess the prevalence of driver oversteering and will examine the effects of training on successfully avoiding a crash. Task 5.1 uses a driving simulator to address this issue. Task 5.2 examines driver crash avoidance behavior in a test track environment on a dry, high coefficient of friction road surface. Task 5.3 also studies driver crash avoidance behavior in a test track environment but on a wet, low coefficient of friction road surface.

Task 6 investigates the effects of ABS during road recovery maneuvers (i.e., when a driver attempts to maneuver an automobile back onto the roadway after a departure). Many road departures occur when the driver maneuvers the vehicle in an essentially straight line that leaves the road. This action may be due to driver inattention, sleepiness, or intoxication. None of these causes are related to the presence or absence of ABS. However, the presence of ABS may or may not influence the ability of the driver to safely return the vehicle to the roadway.

Task 7 looks at the issue of ABS and risk compensation. Several studies have found that people drive faster or more aggressively on test tracks in ABS-equipped vehicles than with

conventionally-braked vehicles. The goal of this task is to try to determine if these trends occur during typical driving on actual public roads.

Task 7 is also divided into multiple subtasks. Task 7.1 will involve remote observation to collect data about the behavior (e.g., speed) of drivers who are unaware of the fact that their behavior is being monitored. Task 7.2 will collect more detailed data about the driving behavior of subjects using instrumented vehicles.

Task 8 will integrate data from all of the preceding tasks and attempt to infer why the crash data studies did not find the anticipated increase in safety for ABS-equipped automobiles.

Task 9 involves the dissemination of task results. NHTSA will share knowledge gained through the program's research efforts by reporting its findings with interested parties within NHTSA and the public at large. Summaries of current research efforts and results-to-date will be presented for discussion. Status briefings will be conducted approximately twice per year to keep stakeholders abreast of task progress and acquire their input.

NHTSA's Light Vehicle ABS Research Program is only a first step in assessing the anticipated safety benefits from ABS. This program deals solely with trying to learn why the crash data studies did not find the anticipated increase in safety for ABS-equipped automobiles. The development of countermeasures to resolve any problems discovered is left to future research.

2.0 BACKGROUND AND STUDY OBJECTIVES

A Test Track Study of Light Vehicle Antilock Brake System Performance Over a Broad Range of Surfaces and Maneuvers was conducted to compare the braking performance of vehicles equipped with present-day antilock brake systems to the performance of the same vehicle without ABS over a large range of driving conditions. The braking performance of nine vehicles, each equipped with a different manufacturer's ABS, was evaluated in eighteen stopping situations involving a variety of road surfaces, driver steering actions, and vehicle speeds. Testing was performed with lightly and heavily laden vehicles and with the ABS active and disabled. Prior to performing the testing described in this report, the test plan for this work was reviewed by several members of NHTSA's MVSRACT ABS Working Group. Their comments were much appreciated.

The motivation for this work was to attempt to find situations and/or conditions in which many vehicles equipped with ABS would not perform as well as their non-ABS (conventionally braked) counterparts. While ABS stopping performance has been measured by many groups over many years, there is a possibility that poor performance on some unusual surface or during some maneuver may have been overlooked. If such conditions could be found, they may explain the apparent increase in single-vehicle crashes of ABS-equipped automobiles. Note that it was not the intention of this work to compare vehicles or antilock brake systems to one another.

ABS performance evaluations have been conducted prior to this study by NHTSA's Vehicle Research and Test Center (VRTC) in East Liberty, Ohio [7,8]. In these earlier evaluations, a number of vehicles equipped with a variety of antilock brake systems were tested over a range of road surfaces and stopping maneuvers. The aim of the earlier research was to assess ABS performance by comparing the braking of individual vehicles with and without ABS.

Both of these earlier studies found that ABS improved vehicular stability under braking, especially when a difference in road friction coefficients existed between the left and right sides of the vehicle. Four-wheel antilock brake systems reduced the tendency of the vehicles to yaw

excessively and allowed the driver to maintain steering control while braking. Rear-wheel only ABS was found to only enhance braking stability, as these systems are not designed to modulate the longitudinal slip of the front wheels during braking. Therefore, although rear-wheel only ABS prevented excessive yaw, no steering control benefits were provided to the driver during braking.

The earlier studies also found that stopping distances on hard, paved test surfaces either stayed the same or were reduced for four-wheel ABS-equipped vehicles. Stopping distance increases of over 25 percent occurred in several cases on loose gravel. In some cases rear-wheel ABS slightly reduced stopping distances and, in other cases, increased it.

The current ABS performance evaluation differs from those previously performed by VRTC in several significant ways. First, the vehicles tested have newer antilock brake systems than those tested in the earlier studies. Second, the vehicles were tested on more surfaces than in the past. Third, the vehicles were tested on a number of surfaces having sudden coefficient of friction transitions (past VRTC testing has found that some antilock brake systems have problems dealing with such transitions). Fourth, the vehicles were tested in additional maneuvers. Again, past VRTC testing found that some systems exhibited braking deficiencies while performing certain maneuvers (e.g., braking while in a hard curve).

3.0 TEST PROCEDURE

3.1 Test Vehicles

The test vehicle fleet included a diverse range of high production passenger vehicles, ranging from compact cars to sport utility vehicles. Eight test vehicles were purchased or leased from central Ohio automobile dealerships. Seven were obtained from used car lots, and one from a dealership's pool car fleet. A ninth vehicle was borrowed from another VRTC test program. The selected vehicles included at least one ABS from each of the eight current, major, ABS manufacturers.

Eight vehicles were equipped with "add-on" ABS packages, and one was "integrated." Although the functionality of these configurations is identical, the integrated ABS physically combines the master cylinder with the hydraulic control unit (HCU) into one component. The master cylinder and HCU of the add-on systems, however, are joined only by the brake lines run between them.

The antilock brake systems in seven of the nine test vehicles used four wheel speed sensors, one at each wheel. The two rear-wheel drive vehicles utilized three wheel speed sensors, one positioned at each front wheel and one in the rear differential. Four vehicles were equipped with four-channel antilock brake systems that independently modulated the front and rear brake line pressures at each wheel. The five remaining test vehicles were equipped with three-channel antilock brake systems that also modulated the two front line pressures independently, but modulated the line pressures at the right rear and left rear together. The ABS configurations of each test vehicle are listed in Table 1.

The tires on each test vehicle were steel belted radials. Each set was inspected and found to be in acceptable condition and of the sizes specified by the vehicles' manufacturers. The brake system components were inspected and replaced if necessary. All hydraulic plumbing and hardware was found to be in new or like new condition. The brake pads, rotors, drums, and shoes were tested

in “as is” condition unless it was necessary to replace them (e.g., one vehicle’s rear brake pads were worn past their wear limits).

Table 1. Test Vehicle ABS Configuration.

	Test Vehicle								
	A	B	C	D	E	F	G	H	I
Vehicle Model Year	1995	1994	1993	1996	1997	1996	1995	1995	1997
Number of Wheel Speed Sensors	4	4	4	4	4	4	4	3	3
Number of Hydraulic Channels	4	4	4	3	4	3	3	3	3
Configuration	add-on	integrated	add-on	add-on	add-on	add-on	add-on	add-on	add-on

It should be noted that this study originally included only eight test vehicles. However, as the eighth vehicle was approaching test completion, seemingly odd ABS behavior was noted in a vehicle being driven in another NHTSA test program. When a large braking input was applied during the program’s steer-and-brake maneuver, the brake pedal would rise quickly and remain firm against the driver’s foot (due to ABS activation) at high lateral acceleration. Although this is not necessarily a negative feature, the pedal rise also coincided with the sensation that the vehicle was not generating the anticipated braking force and vehicle deceleration.

Preliminary braking maneuvers were conducted and confirmed the previously noted pedal feel and perceived stopping distance increase whenever a high lateral acceleration was established prior to a large brake pedal force input. Such behavior was not observed in the eight vehicles of the original test matrix. Recalling that the motivation for this study was to find situations where the use of ABS resulted in some form of stopping deficiency (when compared to the same vehicle equipped

with conventional brakes), it was determined that the vehicle should be subjected to the entire ABS hardware evaluation test matrix as a ninth vehicle.

3.2 Instrumentation

Table 2 provides a list of instrumentation installed in each test vehicle. The fifth wheel assembly was mounted to the rear bumper attachment points and transmitted vehicle speed and distance signals to a digital performance monitor positioned on the dashboard. The monitor's trigger input was activated by the brake light switch to freeze the initial vehicle speed and zero vehicle position when the brake pedal was depressed. The speed and position measured by the fifth wheel were recorded as a function of time with an update rate of 100 Hz by a digital on-board data acquisition system.

Table 2. Instrumentation.

Description	Measured Data	Vehicle Location
Accelerometer	Lateral and longitudinal acceleration	Positioned at center of gravity
Fifth wheel	Vehicle speed and distance traveled	Rear bumper attachment points
Linear position transducer*	Brake pedal displacement	Brake pedal
Load cell	Brake pedal force	Brake pedal
Pressure transducers	Brake line pressure seen at each caliper or drum	Between hard and flexible brake lines at each corner
Rate sensor	Yaw rate	Positioned at center of gravity
String potentiometer*	Steering wheel angle	Steering column
Optical pickup sensor	Event trigger	Front license plate bracket
Wheel tachometers	Individual wheel speed	Each wheel via wheel mounting lugs or lug nuts

*Instrumentation omitted after completion of third vehicle testing.

Brake line pressure transducers were connected between the hard and flexible brake lines to transmit the line pressure seen at each wheel downstream of the ABS HCU. Direct current tachometers attached to each wheel monitored wheel lockup by measuring individual wheel speeds. A load cell was attached to the brake pedal to transmit applied force. Two accelerometers and a rate sensor, positioned at the vehicle's center of gravity to minimize vehicle pitch and roll effects, measured lateral/longitudinal acceleration and yaw rate, respectively. An optical pickup sensor was installed on the vehicle's front license plate bracket to signal a desired point within a braking maneuver. All data measured by this instrumentation was recorded, as a function of time, by the on-board data acquisition and each channel was sampled at a rate of 100 Hz.

Linear position transducers were initially attached to the steering column shaft and brake pedal lever arm to measure steering wheel angle and brake pedal travel, respectively. The magnitude of the steering inputs required by the test driver to maintain lane position and ABS brake pedal feedback were not as severe as anticipated, and were therefore omitted from the instrumentation list after the third vehicle had been tested.

3.3 Loading

Each vehicle was tested at two loading conditions: lightly laden and at its Gross Vehicle Weight Rating (GVWR). Lightly laden was defined as the vehicle curb weight (with a full tank of fuel) plus the test driver and instrumentation. The GVWR condition involved loading the vehicle to the maximum vehicle weight recommended by the manufacturer, and was achieved by ballasting the test vehicle with sand bags distributed so that the axle weights were in proportion with the Gross Axle Weight Ratings (GAWR).

3.4 Road Transducer Plates

Developed by the General Motors Corporation for evaluating passenger car brake force distribution and efficiency, road transducer plate (RTP) testing involved driving a vehicle over four

plates mounted flush with the roadway surrounding them. As the vehicle approached the RTP, the test driver applied a constant brake pedal force great enough to achieve the target speed of approximately 64 km/h (40 mph) at the plates for a given deceleration level. Force transducers attached to the structure of the plates below the surface measured braking forces and transmitted them to a nearby data acquisition system. The force data was interpreted to give average braking forces for individual wheels and, in conjunction with vehicle deceleration measurements, was used to determine the brake balance and braking efficiency of each test vehicle.

3.5 Test Matrix

Table 3 summarizes the eighteen braking maneuvers of this study's test matrix. Testing was performed with the assistance of ABS and with the ABS disabled using two pedal application techniques. The matrix included nine different test surfaces and six different stopping maneuvers, each performed with the vehicles lightly laden and at GVWR. To disable the ABS, an electrical fuse in the test vehicle's fuse box was replaced with a fused toggle switch to interrupt power to the ABS electronic control unit, solenoid valves, or pump motor.

3.6 Test Surfaces

Nine surface types were used for this study: dry asphalt, wet asphalt, dry concrete, wet polished concrete, wet epoxy, grass, loose gravel, wet Jennite, and an epoxy/sand surface. The polished concrete was designed to simulate a heavily worn road and was created by troweling and polishing with a floor polisher. The epoxy pad (asphalt covered with a coating typically used on factory floors) and wet Jennite (a coal tar emulsion asphalt sealer trade name) surfaces simulated badly worn wet roadways. Due to surface deterioration, the epoxy pad was reconditioned before the final two vehicles could be evaluated, reducing the peak coefficient of friction and slide skid numbers by over one third. The grass surface was approximately 7.6 cm (3 in.) in height, and consisted of fescue grown on clay-based soil. The loose gravel was comprised of #617 crushed limestone with dust. The gravel base was approximately 5.1 cm (2 in.) deep.

Table 3. Light Vehicle ABS Test Matrix.

Surface	Nominal ASTM Skid No. (Peak/Slide)	Maneuver	Speed
Dry Concrete	90/75	Straight Line	97 km/h (60 mph)
Wet Polished Concrete	unknown/60	Straight Line	64 km/h (40 mph)
Wet Asphalt	85/65	Straight Line	80 km/h (50 mph)
Wet Jennite	30/10	Straight Line	64 km/h (40 mph)
Grass	unknown	Straight Line	40 km/h (25 mph)
Loose Gravel	unknown	Straight Line	56 km/h (35 mph)
Wet Asphalt to Wet Jennite	(85/65) to (30/10)	Transition	64 km/h (40 mph) Transition at 40 km/h (25 mph)
Wet Jennite to Wet Asphalt	(30/10) to (85/65)	Transition	56 km/h (35 mph) Transition at 40 km/h (25 mph)
Wet Asphalt across corner of Wet Epoxy to Wet Asphalt	(85/65) across corner of (20/3)* to (85/65)	Transition	64 km/h (40 mph) Transition at 40 km/h (25 mph)
ABS Test Pad #0	85/65	Transition	64 km/h (40 mph)
ABS Test Pad #1	(85/65) to (30/10) to (85/65)	Transition	64 km/h (40 mph)
ABS Test Pad #2	(85/65) to (30/10) to (85/65) to (30/10) to (85/65) to (30/10) to (85/65)	Transition	64 km/h (40 mph)
ABS Test Pad #3	(85/65) to unknown to (85/65)	Transition	64 km/h (40 mph)
Wet Asphalt/Wet Epoxy	(85/65) / (20/3)*	Split-Mu	48 km/h (30 mph)
Dry Asphalt	90/80	Curve (91.4 m radius)	80 km/h (50 mph)
Wet Jennite	30/10	Curve (152.4 m radius)	64 km/h (40 mph)
Dry Asphalt	90/80	J-turn	80 km/h (50 mph)
Wet Asphalt to Wet Asphalt/ Wet Epoxy Split	(85/65) to (85/65) / (20/3)*	Single Lane Change to Split-mu	80 km/h (50 mph)

*The actual skid numbers of the epoxy surface exceeded the nominal specifications for the first seven test vehicles. The average peak and slide values recorded during this time interval were 52 and 14, respectively.

This study also utilized a specially designed ABS test course. Created in mid-1996, the course was designed to evaluate ABS performance on a series of simulated real world test pads. An antilock brake system's ability to recover vehicle deceleration after returning to smooth asphalt from a given pad was observed. Each of the four ABS test course pads was wet during testing. Test Pad #0 was used to determine vehicle stopping distance for the wet, unperturbed asphalt surface of the course. Test Pad #1 included one Jennite strip 61 cm (24 in) wide applied to the asphalt to simulate a stop bar found at an intersection with a stop sign or traffic light. Test Pad #2 (Figure 1) simulated a stop bar followed by two bars to mark crosswalk area, and was oriented as follows: a 61 cm (24 in) wide Jennite stop bar, four feet of asphalt, a 25 cm (10 in) Jennite strip, six feet of asphalt, and a second 25 cm (10 in) Jennite strip. Test Pad #3 (Figure 2) consisted of two adjacent artificial potholes, one in each wheel track, constructed from steel frames set into concrete and treated with an epoxy/sand surface. The wet epoxy/sand surface provided a coefficient of friction very similar to dry pavement.

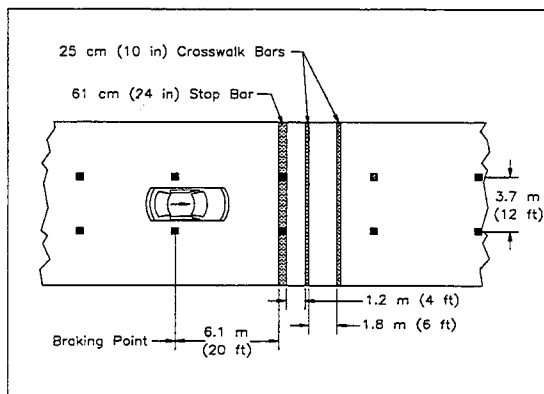

Figure 1. ABS Test Pad #2.

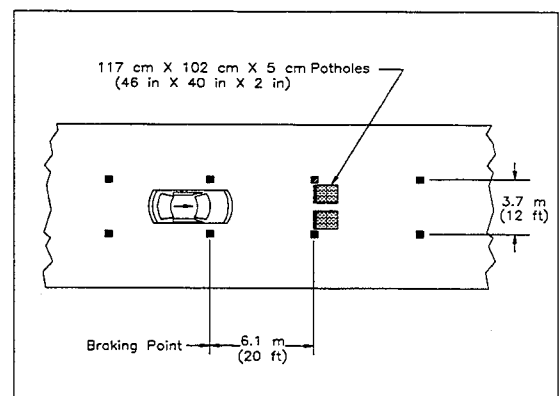

Figure 2. ABS Test Pad #3.

3.7 Surface Friction Measurements

The nominal peak coefficient of friction and slide skid numbers of each test surface were determined using standardized American Society for Testing and Materials (ASTM) procedures and equipment. The peak coefficient of friction, determined by using ASTM procedure E1337 with an

E1136 tire, usually occurs just prior to wheel lock up when longitudinal frictional forces between the tires and the road surface are the greatest [8,9]. As with the peak values, the skid numbers (100 times the sliding coefficient of friction, determined by ASTM procedure E274 with an E501 tire) presented in Table 3 represent approximate values, as they vary slightly on a daily basis [10,11]. Factors such as surface temperature, weather conditions, pavement aging, and wear all contribute to surface friction variability.

3.8 Maneuvers

This study involved six stopping maneuvers: 1) straight line, 2) split-mu, 3) transition, 4) curve, 5) J-turn, and 6) single lane change. Straight line maneuvers involved stopping on a uniform coefficient surface and were conducted at 97 km/h (60 mph) on dry concrete, at 64 km/h (40 mph) on wet polished concrete and wet Jennite, and 80 km/h (50 mph) on wet asphalt. Split-mu maneuvers required straight line stopping over a surface with different side-to-side frictional coefficients and were conducted at 48 km/h (30 mph). Transition maneuvers (Figures 3 and 4) were made while the driver applied a panic brake application as the vehicle traveled over surfaces with changing frictional coefficients and were each conducted using an entrance speed of 64 km/h (40 mph), with one exception—the wet Jennite to wet asphalt maneuver used an entrance speed of 56 km/h (35 mph). The vehicle speed and brake application points were chosen such that the initial surface transition would be accomplished at approximately 40 km/h (25 mph).

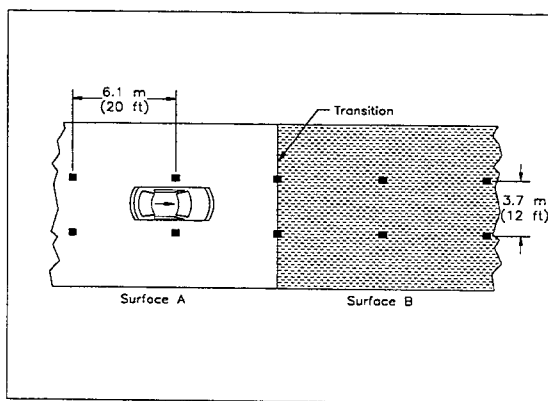

Figure 3. Perpendicular transition.

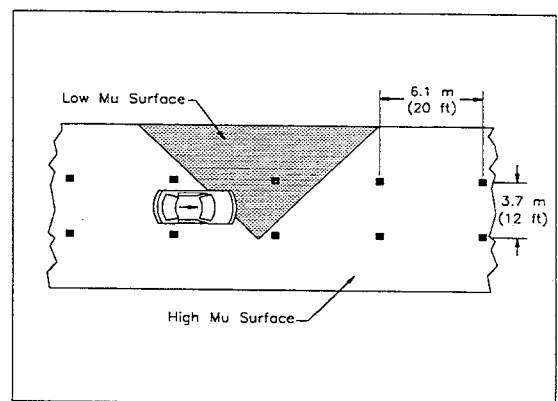

Figure 4. Offset transition.

Braking in a curve of known radius (Figure 5) and in the J-turn, a maneuver designed to observe how a vehicle responded to a sudden and severe steering input quickly followed by a brake application (Figure 6), occurred on surfaces with uniform frictional coefficients. Dry asphalt curve and J-turn testing was conducted at 80 km/h (50 mph), while wet Jennite curve testing was conducted at 64 km/h (40 mph).

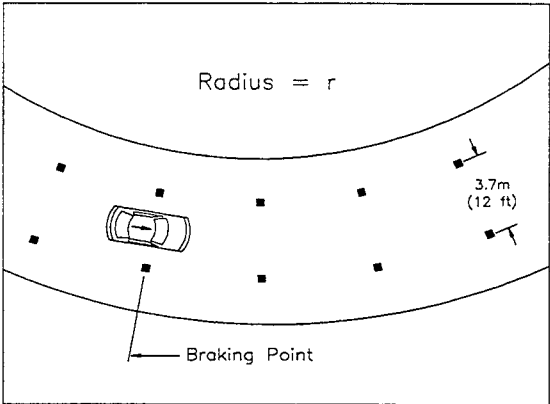

Figure 5. Braking in a turn.

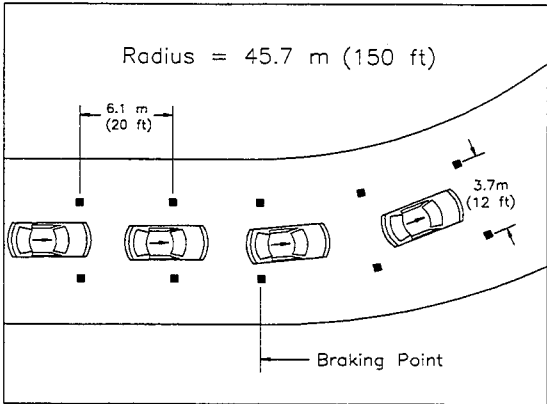

Figure 6. J-turn maneuver. Approach is tangent to a 45.7 m (150 ft) radius curve.

The lane change maneuver involved a high speed single lane change from a uniform coefficient surface to a split-mu surface, and was designed to approximate a collision avoidance maneuver in which a vehicle transitions from a high coefficient of friction roadway lane to a split high coefficient of friction roadway/lower coefficient of friction shoulder lane (Figure 7). Single lane change testing was conducted at 80 km/h (50 mph).

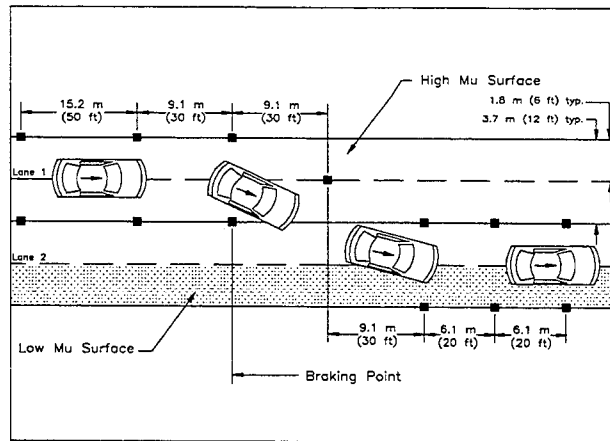

Figure 7. Single lane change maneuver.

All stopping lanes were 3.7 m (12 ft) wide, marked with cones spaced 6.1 m (20 ft) apart. For each maneuver, the test driver was allowed to make steering inputs as necessary to maintain lane position. The 91.4 m (300 ft) radius curve, Jennite curve, straight line stops on Jennite, asphalt and split-mu, J-turn, and lane change were conducted on lanes with a one percent left to right cross slope and negligible longitudinal slope. The wet concrete maneuver was performed on a lane with a one-half percent downward longitudinal slope with no cross slope. The gravel stopping maneuver was conducted on a lane with a one percent downward longitudinal slope with negligible cross slope. Finally, the grass stops were performed on an uneven grass lane with an approximate 1.5% upward longitudinal slope and no cross slope.

3.9 Stopping Distance Correction

The target speeds specified for each maneuver were chosen to reflect available space, real world utility, and safety considerations. Although these speeds are listed in Table 3, the actual speeds observed while testing varied slightly. As a result, the actual stopping distances were adjusted to represent the distances of those maneuvers as if they had been run at the target speed using the following expression [12]:

$$s' = \frac{v_{target}^2}{v_{actual}^2} \times s_{actual} \quad \text{where}$$

$$s' = \text{corrected stopping distance}$$

$$v_{target} = \text{target initial vehicle velocity}$$

$$v_{actual} = \text{actual initial vehicle velocity}$$

$$s_{actual} = \text{actual stopping distance}$$

3.10 Brake Applications

Two brake application techniques were used in this study: 1) “panic” and 2) “best effort.” Panic applications involved a rapid force application of over 667 N (150 lbs) to the brake pedal. These stops were expected to be very repeatable, therefore only three panic stops for each case (ABS and disabled ABS) were conducted. Best effort stops required the driver to modulate pedal effort as necessary to achieve the shortest possible stopping distance while maintaining vehicle control and lane position. No more than one wheel per axle was permitted to lock during best effort stops to ensure vehicular stability was maintained. To allow time for driver familiarization with a given vehicle’s braking ability, six best effort stops were run for the maneuvers that required them. To eliminate driver variability effects, only one professional test driver with 17 years experience served as driver for all testing conducted for this study.

With the exception of the transitional stops on the ABS test course, each transition maneuver only included three ABS-assisted stops. Transitional maneuvers were designed to evaluate ABS reaction times and responses to sudden changes in roadway frictional coefficients. For this reason, it was unnecessary for disabled ABS stops to be conducted.

Three ABS and disabled-ABS panic stops were performed on the grass and loose gravel surfaces. Data collected from straight line best effort stops made on these surfaces, at the low test speeds specified in the test plan, were not expected possess real-world significance. Best effort stops, therefore, were not conducted on grass and gravel.

Braking in a curve and J-turn maneuvers, as well as the single lane changes, did not require panic stops with the ABS disabled as it was expected that the vehicles would quickly lock their front wheels and skid out of the intended stopping lane. Disabled ABS panic stops were likewise omitted from wet asphalt, dry asphalt, wet polished concrete, and dry concrete maneuvers due to the excessive tire wear executing such stops was expected to incur. For these eight maneuvers only three ABS-assisted and six best effort disabled ABS stops were conducted.

4.0 ROAD TRANSDUCER PLATE RESULTS

Brake efficiency and front/rear brake force distributions were measured for the nine test vehicles using the VRTC RTP. The vehicles were each evaluated at their respective GVWRs. Due to the fact that braking forces are independent of vehicle weight, RTP testing was not conducted for the lightly laden loading condition. Additionally, the fully laden loading condition was expected to allow greater longitudinal decelerations to be reached before wheel lockup, increasing the number of data points available for brake system performance analysis.

Braking efficiency describes a vehicle's ability to use the available surface friction prior to wheel lockup. One measure of this efficiency is the ratio of longitudinal deceleration to the surface coefficient of friction, therefore the maximum deceleration a vehicle can achieve is attained when the two values are equal. A brake system is said to operate at 100% efficiency when the wheels of both axles reach the point of impending lockup at the same time, as maximum braking force is being generated at each wheel.

On a test track, the extent to which a vehicle's stopping distances are reduced due to the presence of ABS is largely dependent on the vehicle's braking efficiency. A vehicle with a high braking efficiency should, in theory, enable the driver to achieve stopping distances very similar to ABS-assisted distances when the ABS is disabled, assuming driver is able to modulate the brakes such that use of the available surface friction is optimized. In the real world, few people have the ability to modulate brakes in this fashion, especially in a panic stop situation.

A vehicle with poor braking efficiency prevents the driver from using the full capacity of the underbraked axle due to premature wheel lockup. This lockup also results in a loss of driver control and induces directional instability in the vehicle. It is important to note that even if a vehicle is equipped with a brake system that is 100% efficient, if the driver is unable to modulate the brakes correctly, they will lock all four wheels and lose control of the vehicle.

Using data collected from the RTP, brake distribution was plotted as a function of vehicle deceleration; figures 8 and 9 represent the results of the test vehicle “D”. For this vehicle’s particular test set, eleven snubs were made with the vehicle fully laden and its ABS disabled. Figure 8 indicates that the test vehicle was front-biased (the front wheels would lock before the rear wheels, given a sufficient brake pedal force input) and that as the longitudinal deceleration increased, the contribution of the rear brakes decreased (due to the reduced normal force over the rear axle). Figure 9 predicts braking efficiency versus surface friction for the same vehicle during the same stops. This plot indicates that braking efficiency remained quite uniform when the surface coefficient of friction ranged from 0.2 to 0.7. As the surface frictional coefficients increased above 0.7, braking efficiency increased slightly.

Antilock brake systems are designed to optimize vehicle braking for the amount of available tire/road surface friction through the modulation of brake line pressure and thus wheel slip. Because the RTP only provides a small snapshot of the braking forces being applied to the plates, it was deemed inappropriate to conduct RTP testing with the ABS active. Although the effect of having an ABS remain active during low to moderate decelerations would have been transparent (the ABS would not have cycled), when the ABS began to operate at higher decelerations the resulting force measurements may have been misleading.

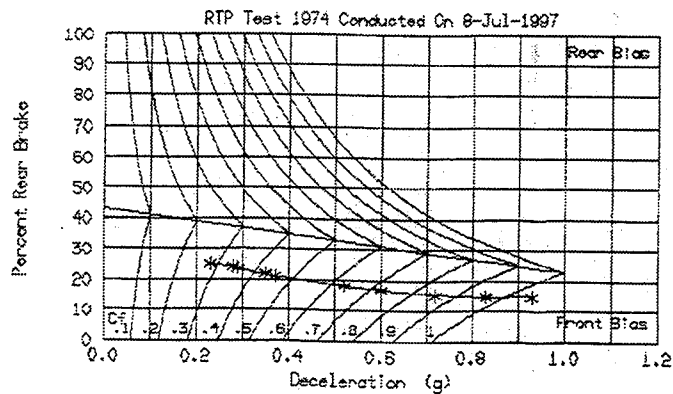

Figure 8. Brake distribution as a function of vehicle deceleration (test vehicle “D”).

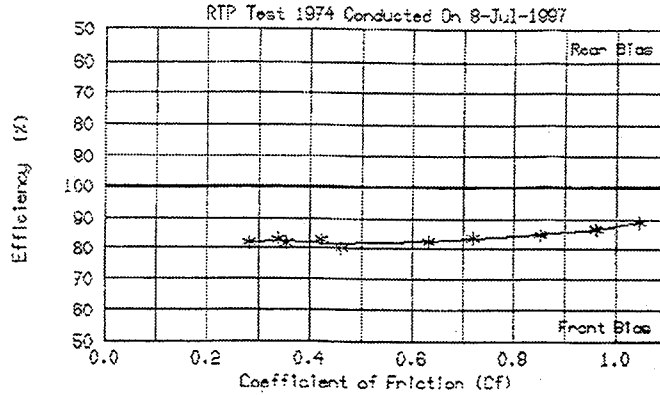

Figure 9. Braking efficiency as a function of surface coefficient of friction (test vehicle “D”).

Consider the example of a vehicle whose foundation brake system is front-biased and whose front wheels have exceeded the antilock brake system’s allowable wheel slip threshold just prior to the vehicle passing over the RTP. If the ABS was in the process of releasing front brake line pressures (to reduce wheel slip) at the time of the data acquisition snapshot, the amount of tire force being generated across the RTP at the front wheels may be quite low. The RTP computer does not recognize that the reduction of braking force at the front wheels is due to the operation of the ABS, it simply compares the braking forces of the front to the rear of the vehicle over a very short period of time. Due to the fact that the rear braking forces were unaffected by the modulation of the front line pressures, the RTP would interpret the vehicle’s brake system as being more rear-biased than it actually was. Note that if it was possible to increase the RTP sampling interval, average braking forces at each wheel may be better determined due to the increased number of data points. This action would facilitate the use of ABS on the RTP as it would provide a more accurate representation of the vehicle’s brake force distribution and efficiency with the ABS active.

Overall, the brake efficiencies of the test vehicles ranged from 65 to 92%. On the average, test vehicle brake efficiencies were greatest when the simulated surface’s frictional coefficient was 0.85, approximately that of dry asphalt. Each vehicle was found to be front biased, locking its front wheels first when the available surface friction was exceeded at high decelerations.

For each vehicle, braking efficiency was quite consistent across the range of surface friction coefficients. On the average, the highest and lowest brake efficiencies differed by 11.2 percent. Table 4 includes the brake efficiencies for each of the test vehicles for coefficients of friction ranging from 0.2 to 1.0. Recall that all vehicles were evaluated at their respective GVWRs.

Table 4. Test Vehicle Braking Efficiency (%) as a Function of Surface Coefficient of Friction.

Vehicle	Coefficient of Friction								
	0.2	0.3	0.4	0.5	0.6	0.7	0.8	0.9	1.0
A	80	76	72	71	72	72	85	n/a	n/a
B	n/a	78	77	76	77	77	77	78	80
C	n/a	74	75	75	76	76	70	74	75
D	n/a	82	82	82	83	84	85	86	88
E	83	81	80	82	83	84	86	n/a	n/a
F	n/a	85	90	92	90	88	89	90	90
G	73	73	74	75	75	75	78	80	85
H	n/a	75	75	77	80	84	88	93	n/a
I	n/a	69	72	73	73	75	75	78	84

Note: test vehicles were each evaluated at their respective GVWRs.

5.0 TEST TRACK RESULTS

5.1 Comments on the Reporting of ABS Performance Results

The results reported in this section used stopping distance and vehicle stability as measures of braking performance. A vehicle yawing out of control with its wheels locked may stop in a very short distance, while a stable vehicle (its directional control maintained throughout the duration of the stop) may require a very long distance to complete its stop. Each condition presents different safety concerns and demonstrates why stopping distance and directional stability must be evaluated together when discussing ABS performance.

A number of charts provide stopping distances observed with fully laden test vehicles in this section of the report. These charts represent a sample of the complete stopping distance chart set found in the appendix. If a legend is not included with a given chart, the reported stopping distances were collected using ABS-assisted panic brake applications. If a legend is provided, “ABS” refers to an ABS-assisted panic stop, “Full Pedal” refers to a panic stop with the ABS disabled, and “Best Effort” refers to test driver modulated stops made with the ABS disabled.

Thirteen of the eighteen stopping maneuvers required ABS-assisted stopping distances to be compared to those measured with the ABS disabled. To facilitate this comparison, the following equation was used:

$$ABS \text{ Stopping Distance Improvement} = \frac{SD_{ABS \text{ disabled}} - SD_{ABS}}{SD_{ABS \text{ disabled}}} \times 100\%$$

where

$$SD_{ABS \text{ disabled}} = \text{stopping distance achieved with an ABS disabled (panic or best effort)}$$
$$SD_{ABS} = \text{stopping distance achieved with the assistance of an ABS}$$

Although the ninth test vehicle was to be subjected to the entire ABS test matrix, completion of all lightly laden tests was not possible. For this reason, many charts for this loading condition include stopping distances for eight vehicles only.

5.2 Straight Line Stops on Uniform Coefficient Surfaces

Panic brake applications used in conjunction with ABS resulted in the shortest straight line stopping distances on the dry concrete and wet polished concrete surfaces for all nine test vehicles at both loading conditions (Figure 10 summarizes the GVWR stopping distances made on dry concrete). Antilock brakes also facilitated the shortest stopping distances on the wet Jennite (Figure 11) and wet asphalt surfaces for each vehicle when fully laden.

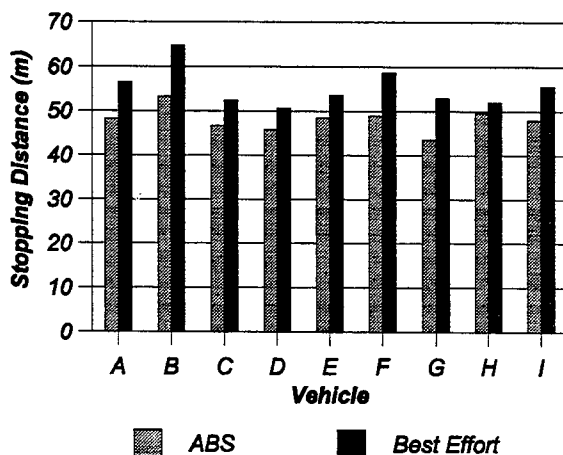

Figure 10. Straight line stopping distances observed on dry concrete. Test vehicles were fully laden to their respective GVWRs.

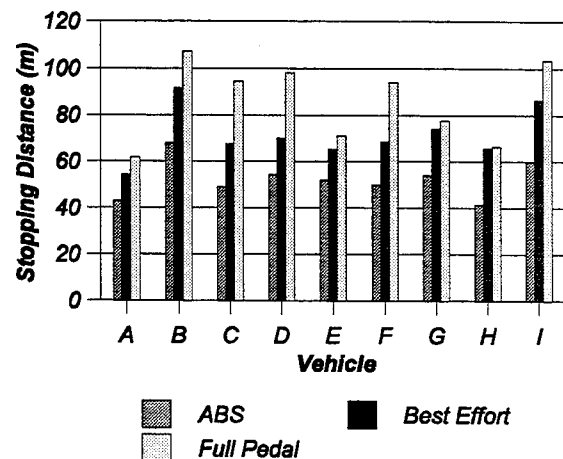

Figure 11. Straight line stopping distances observed on wet Jennite. Test vehicles were fully laden to their respective GVWRs.

On wet asphalt, for the lightly laden loading condition, eight of the nine vehicles stopped in the shortest distance with ABS. The test driver's minimum best effort stopping distances were 4.9% less than the ABS-assisted stops with vehicle "H" on wet asphalt. On wet Jennite, for the lightly laden loading condition, seven of the eight vehicles stopped in the shortest distance with ABS. The

test driver's minimum best effort stopping distances were 9.2% less than the ABS-assisted stops with vehicle "A" on wet Jennite. Lightly laden straight line stops on wet Jennite were not performed with test vehicle "T".

5.3 Straight Line Stops on Off-road Surfaces

5.3.1 Grass

Seven of the nine test vehicles laden to GVWR stopped in the shortest distance when a panic brake application was used in conjunction with ABS on the grass surface (Figure 12). The ABS-assisted stops were an average of 6.9% shorter than those made with the ABS disabled at GVWR. This percentage drops to 4.0% if the stopping distances of vehicle "T" are not included in this comparison. Unlike the other vehicles, test vehicle "T" was evaluated on very wet grass at GVWR, and in some areas standing water was present. These test conditions explain why the disabled-ABS stopping distance was 30.1 percent longer than that obtained with ABS for this vehicle. Although skid numbers were not available, it is reasonable to assume the wet grass possessed a much higher peak-to-sliding coefficient of friction ratio than when dry (generally speaking, grass-covered dirt is not homogeneous and attempting to obtain skid numbers would yield highly variable results). A large peak-to-slide ratio predicts wheel lockup will significantly reduce available braking force from what it would be if the wheels were not locked, as in an ABS-assisted stop. Vehicle "T" locked all four wheels on the wet grass, therefore it is not surprising the disabled-ABS stopping distance was significantly longer than that of the ABS-assisted stop.

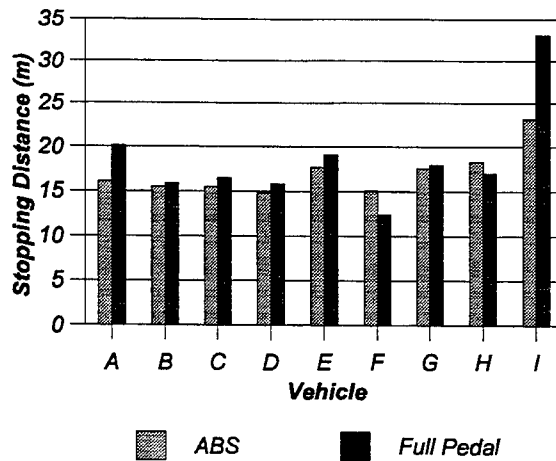

Figure 12. Straight line stopping distances observed on grass. Test vehicles were fully laden to their respective GVWRs. Note: the grass was very wet when the braking performance of vehicle “T” was evaluated.

In contrast to the results obtained at GVWR, six of the eight vehicles stopped in the shortest distance with the ABS disabled when lightly laden. At this loading condition the ABS-assisted stopping distances were an average of 7.1 percent longer than the disabled-ABS panic stops across the eight vehicle test group. Test vehicle “T” was not evaluated on the grass when lightly laden.

5.3.2 Loose Gravel

On loose gravel, each of the nine vehicles stopped in the shortest distance with a panic brake application and disabled ABS, regardless of loading condition. Stops made on the gravel were lengthened considerably when the ABS was active: 24.6% when the test vehicles were fully laden (Figure 13) and 30.0% when lightly laden. The fully laden percentage drops to 23.4% if the stopping distances of vehicle “T” are not included in this comparison. As with the grass surface, the gravel was very wet when test vehicle “T” was evaluated, unlike for the other vehicles. This may explain the 33.7% stopping distance increase with ABS when compared to the distance observed with the ABS disabled.

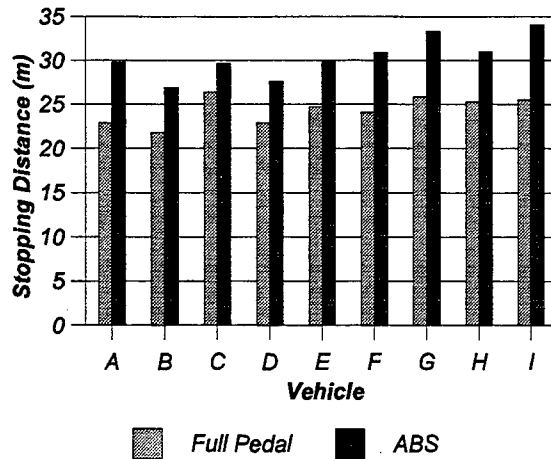

Figure 13. Straight line stopping distances observed on loose gravel. Test vehicles were fully laden to their respective GVWRs. Note: the gravel was wet when the braking performance of vehicle “I” was evaluated.

The ABS-induced stopping distance increase may be best explained by examining the tire-to-roadway surface interaction during the braking maneuver. It is generally accepted that the plowing of a vehicle’s tires into a deformable surface such as loose gravel generates greater stopping forces than if the wheels were allowed to continue to roll over the surface (as in an ABS-assisted stop). Stopping distances made over the gravel surface therefore represent an inherent ABS design compromise. To preserve the driver’s ability to maintain directional control of the vehicle while braking, the wheels must not be allowed to lock. By preserving this control, however, stopping distances made over the gravel test surface were extended.

5.4 Transition Surface Braking

The transition stopping maneuvers were designed to detect gross deficiencies in ABS performance through the observation of unusually long stopping distances and vehicle instability. For each of the nine vehicles, evaluated over three transitions, no apparent shortcomings were revealed. Figure 14 presents typical results. This figure, shows the stopping distances recorded on the wet asphalt/wet Jennite transition surface for the test vehicles at their respective GVWRs.

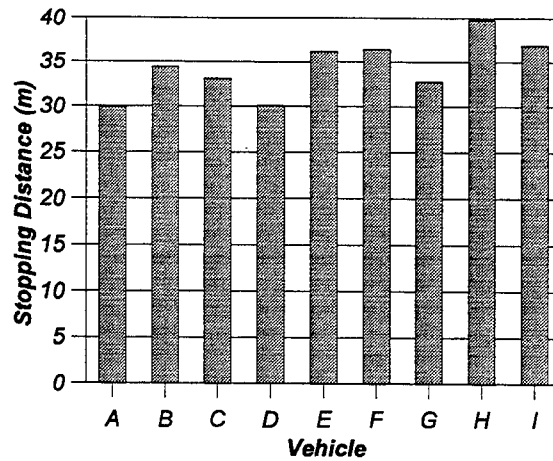

Figure 14. Straight line stopping distances observed on the wet asphalt/wet Jennite transition surface. Test vehicles were fully laden to their GVWRs.

5.5 ABS Test Course Braking

All nine test vehicles, under both loading conditions, stopped in the shortest distance when the test driver utilized a panic brake application with ABS on Test Pad #0, #1, and #2. On Test Pad #3, eight vehicles stopped in the shortest distance using ABS-assisted panic brake applications, as shown in Figure 15 for the GVWR case (the braking performance of test vehicle “T” was not evaluated on this surface). When lightly laden, the shortest stopping distance observed on ABS Test Pad #3 for vehicle “H” occurred when the driver utilized a panic brake application with the ABS disabled. In this case the ABS-assisted panic stop increased the vehicle’s stopping distance slightly (2.0%) over the disabled ABS panic stop.

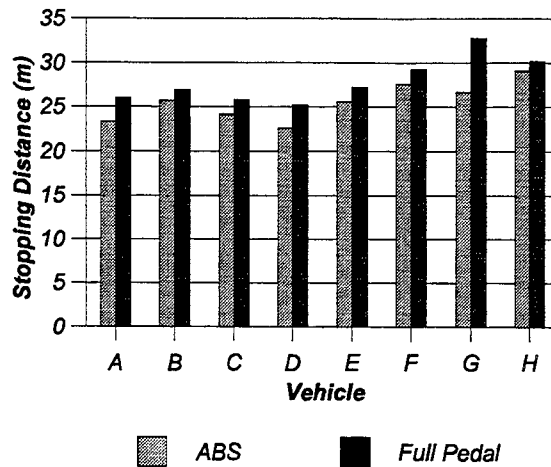

Figure 15. Straight line stopping distances observed on ABS Test Pad #3 (wet). Test vehicles were fully laden to their respective GVWRs. Vehicle “T” braking performance was not evaluated.

5.6 Split-mu Surface Braking

Under both loading conditions, seven of the nine test vehicles achieved the shortest wet asphalt/wet epoxy split-mu stopping distances when the driver used an ABS-assisted panic brake application (see Figure 16 for the fully laden results). When the ABS was disabled and a panic brake input applied, each test vehicle deviated from its stopping lane by yawing out of control (in fact, test vehicle “F” spun 180° for both loading conditions). With ABS, however, the driver had no problem maintaining control of each vehicle while braking during the maneuver. These results provide a clear demonstration of how beneficial the assistance of ABS was for this test condition.

The shortest stopping distances for vehicle “H” and “T” were achieved with a panic brake application and disabled ABS. For vehicle “H”, the disabled ABS panic stops provided lightly laden and fully laden stopping distances 29.3% and 16.5% shorter than the ABS-assisted stops, respectively. The same brake application and disabled ABS also resulted in the shortest stopping distances for vehicle “T”, although with much less difference when lightly laden. The disabled ABS

panic stops provided lightly laden and fully laden stopping distances 13.3% and 0.8% shorter than the ABS-assisted stops, respectively, for test vehicle "T". Both of these vehicles, however, deviated nearly 3 m (10 ft) from their 3.7 m (12 ft) wide stopping lane, under each loading condition, with the ABS disabled due to yaw induced by the lane's two frictional coefficients.

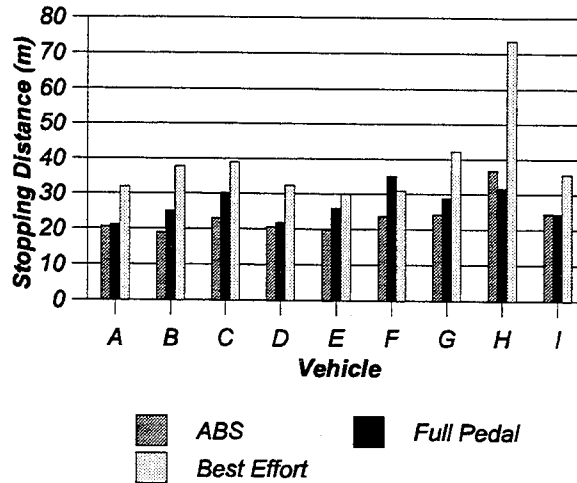

Figure 16. Straight line stopping distances observed on the wet asphalt/wet epoxy split-mu surface. Test vehicles were fully laden to their respective GVWRs. Note: the epoxy surface was reconditioned prior to the brake performance evaluation of vehicles "H" and "T".

The longest stopping distances recorded during the split-mu surface braking tests, with the exception of vehicle "F" at each loading condition, resulted from best effort stops made with the ABS disabled. This is best explained by recalling the wheel lock limitations imposed by the best effort criteria—no more than one wheel per axle was allowed to fully lock if a run was to be deemed valid. Successfully fulfilling this requirement proved to be very demanding for the test driver, as considerable attention to brake pedal modulation was required to prevent unwanted wheel lock on the epoxy side of the stopping lane. As a result, the minimized wheel lock increased vehicular stability (no valid best effort stop ever resulted in loss of control due to excessive yaw) but extended the stopping distances for eight of the nine vehicles.

The large stopping distance differences between the ABS-assisted and best effort stopping distances for vehicle “H” were most likely due to the extremely low frictional coefficient of the resurfaced epoxy pad and the test driver’s unfamiliarity with its characteristics. The surface made it much more difficult for the test driver to prevent wheel lock up through brake force modulation with this vehicle than with those driven prior to it. As the driver became more familiar with the surface, after vehicle “H” testing was complete, the driver was able to better modulate pedal applications to optimize braking. This is indicated by the significant decrease in the ABS-assisted/non-ABS best effort stopping distance differential for vehicle “T” when compared with the results obtained from vehicle “H”.

5.7 Braking in a Curve

Two tests involved braking in a curve of known radius: stops made on the wet Jennite 152.4 m (500 ft) radius curve and dry asphalt 91.4 meter (300 ft) radius curve. None of the test vehicles yawed out of control and, with one exception, stopping distances on the wet Jennite curve were found to be shortest with ABS-assisted panic applications at both loading conditions (Figure 17). The stopping distance achieved by test vehicle “A” using a best effort pedal application was 3.7% shorter than the comparable ABS-assisted distance on the wet Jennite curve when lightly laden. Note that test vehicle “T” was not evaluated on this curve when lightly laden.

Eight of the nine test vehicles were stopped in the shortest distances using ABS-assisted panic brake applications on the dry asphalt curve (Fig 18). This trend was not observed for test vehicle “T”, as its ABS-assisted stops were observed to be longer than the driver’s best efforts when lightly laden and at GVWR, 22.5% and 11.4%, respectively. Analysis of vehicle “T’s” braking performance indicated that when a panic brake input was applied while the vehicle was experiencing a high lateral acceleration, the ABS would release brake line pressure at all four wheels and hold it very low during the first few seconds of the braking maneuver. As the vehicle scrubbed off speed, line pressures were gradually allowed to build. It was not until late in the braking maneuver that brake line pressures were allowed to increase to a level great enough to significantly affect the

vehicle's longitudinal deceleration. It should be noted that test vehicle "T" was the only vehicle whose ABS included the capability to monitor the vehicle's lateral acceleration. Further investigation is necessary to determine whether this feature contributed to the apparently extended stopping distances.

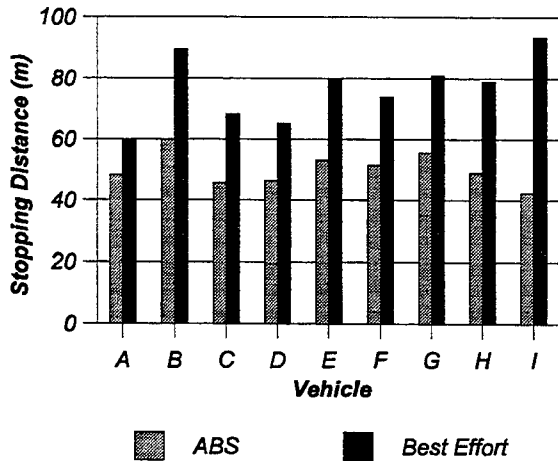

Figure 17. Stopping distances observed on the 152.4 m (500 ft) wet Jennite curve. Test vehicles were fully laden to their respective GVWRs.

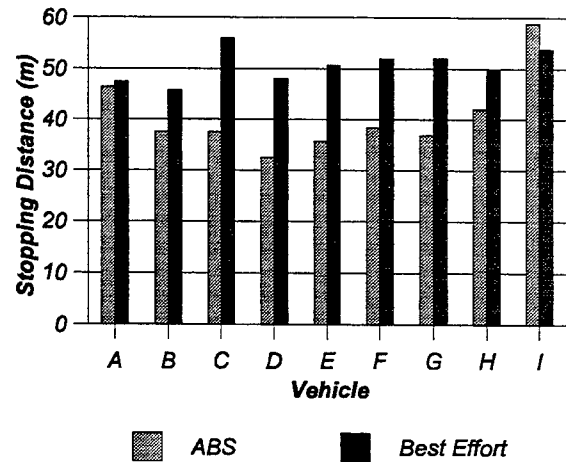

Figure 18. Stopping distances observed on the 91.4 m (300 ft) radius dry asphalt curve. Test vehicles were fully laden to their respective GVWRs.

5.8 J-turn Stopping Maneuver

The J-turn maneuver was designed to observe ABS braking performance while a test vehicle was undergoing hard cornering. Each ABS prevented its respective the test vehicle from yawing out of control, and allowed seven of the nine vehicles to perform as expected. Vehicles "C" and "T" did exhibit noteworthy braking behavior (see Figure 19 for the fully laden vehicle stopping distances).

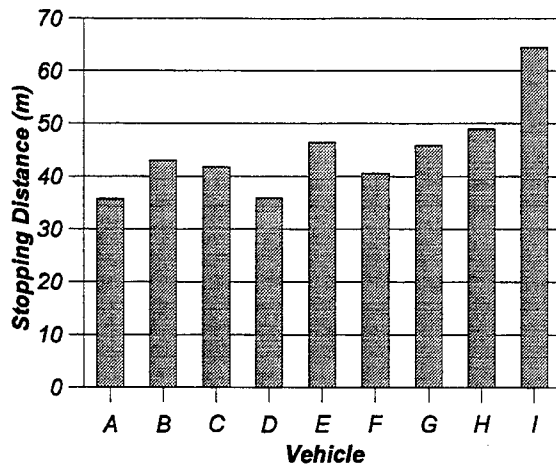

Figure 19. J-turn stopping distances observed on dry asphalt. Test vehicles were fully laden to their respective GVWRs.

Test vehicle “C” deviated an average of 2.5 m (8.3 ft) from its intended stopping lane in all three ABS-assisted panic stops when lightly laden. This vehicle’s stopping distances were not noticeably extended, however, and the ABS was not considered to be responsible for this occurrence. For this case, it was believed that the lateral road holding capacity of the test vehicle was exceeded as it entered the J-turn, inducing understeer. The understeer condition subsided as the vehicle was slowed, and there was no excessive yaw present throughout the stop.

When fully laden, test vehicle “I”’s J-turn stopping distance increased 49.1% over the lightly laden distance. This increase was far greater than the average increase of the other vehicles (3.4%) and its cause is unknown. The test driver’s steering and brake inputs were nearly identical for both loading conditions, yet the vehicle’s braking performance differed significantly.

5.9 Single Lane Change onto a Split-mu Surface

The single lane change test was designed to evaluate ABS performance during an aggressive, transient, brake and steer maneuver.

The objective of this maneuver was to look for the possible braking performance degradation of ABS equipped vehicles near the limit of lateral adhesion. If the maneuver entrance speed caused a vehicle to exceed its lateral roadholding ability, excessive yaw following the driver's steering reversal would occur. For some runs, the driver was unable to regain control of the vehicle, and the vehicle would spin out. This was not considered to be an ABS deficiency, as ABS cannot create lateral force. Although ABS is designed to reduce the incidence of spinouts, it cannot completely prevent them. Excessive yaw and/or loss of control results still occurred if, for a particular run, the test driver steered so as to exceed the limit of lateral adhesion (i.e., the maneuver demanded more lateral friction from the vehicle than it was able to deliver, with or without ABS).

One of the major benefits of ABS is that, unlike conventionally braked vehicles, it allows the driver to control the path of the vehicle while performing hard and/or panic braking. Drivers will generally use this additional path control to avoid crashes and/or roadway hazards. However, occasionally, drivers will steer their ABS equipped vehicle onto a more "difficult to drive on" surface than they would have otherwise driven over by going straight ahead with a non-ABS equipped vehicle. The single lane change maneuver was designed to study what might happen when this situation occurs. As explained in the preceding paragraph, the excessive yaw and loss of control results that were seen for some vehicles in this maneuver do not necessarily indicate ABS problems.

Unlike most of the other maneuvers used in this program, ABS-assisted braking performance in the single lane change test was not compared with disabled-ABS performance. Therefore results from this maneuver cannot be used to draw conclusions about the performance of ABS versus non-ABS equipped vehicles.

The ABS-assisted braking performance of the test vehicles could not be compared to their performance with ABS disabled because disabled-ABS panic braking would have caused the test vehicles to lock their front wheels and skid out of the test course without making a lane change. By not making the lane change, no portion of the vehicle would have been driven onto the low coefficient portion of the test surface. As a result, the disabled-ABS vehicle would achieved shorter

stopping distances. However, this is not the situation that this test maneuver was attempting to simulate. Therefore comparisons of a vehicle's ABS enabled versus ABS disabled braking performance for this maneuver are not meaningful.

The braking performance of each ABS during the single lane change onto a wet asphalt/wet epoxy split-mu surface was found to be acceptable. Figure 20 shows the fully laden vehicle stopping distances recorded for this maneuver. The stopping distances of vehicle "H" and "T" were most likely extended due to the very low coefficient of friction of the newly reconditioned epoxy surface. Test vehicle "T" was not evaluated at the lightly laden loading condition.

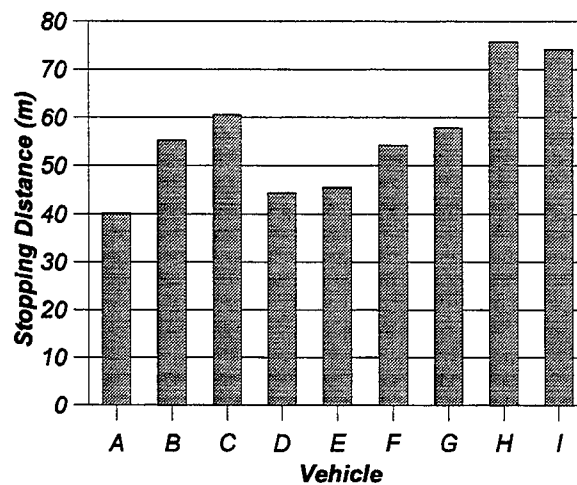

Figure 20. Wet asphalt to wet asphalt/wet epoxy split-mu single lane change stopping distances. Test vehicles were fully laden to their respective GVWRs. Note: the epoxy surface was reconditioned prior to the brake performance evaluation of vehicles "H" and "T".

Five vehicles, under various loading conditions, experienced excessive yaw and loss of control while attempting the lane change during one or more test runs. For these vehicles, Table 5 provides test driver comments indicating whether vehicle control was lost (lane deviation or degrees of vehicle rotation at the end of the stop) and specifies the actual maneuver entrance speeds. It is not

believed that the antilock brake systems were responsible for the lost control, rather than the maneuver imposed handling demands that exceeded the capabilities of the test vehicles.

The single lane change was designed to record ABS responses *near the limit* of lateral adhesion. The fact that some vehicles exhibited excessive yaw upon crossing the high-to-low coefficient transition during one or more runs for a given test series was therefore not surprising. If the lateral road holding capacity of a vehicle was exceeded as it crossed the transition line (after the test driver's counterclockwise steering reversal), the vehicle would yaw due to its rotational inertia. Furthermore, this yaw was likely exacerbated by the vehicle's tendency to pull toward the higher coefficient surface while braking in the split- μ lane. If the tires that transitioned onto the low coefficient epoxy were unable to achieve the lateral forces necessary to prevent sliding due to these effects, the driver would lose control of the vehicle. With the exception of vehicles "H" and "T" when lightly laden and vehicle "C" at GVWR, each vehicle was able to successfully complete at least one run in which loss of control was not experienced at the desired test speed.

Table 5 demonstrates that the maneuver entrance speeds for a given test series were very similar, often differing by less than 3.2 km/h (2 mph). It would therefore appear that the manner in which the test driver navigated the vehicles through the course (the phasing of the steering and brake inputs, the magnitude of the steering inputs, and the point in time when the steering reversal occurred) would be the most significant factor in determining whether a vehicle would be able to complete the maneuver without excessive yaw. For example, Table 5 indicates that when lightly laden, vehicle "C" successfully completed the lane change maneuver at 81.6 km/h (50.7 mph), but instability caused the vehicle to deviate from its intended stopping lane by 3.0 m (10 ft) at 81.9 km/h (50.9 mph), and spin 180° at 83.4 km/h (51.8 mph).

Table 5. Single Lane Change Results.

Vehicle	GVWR Run Number						Lightly Laden Run Number					
	1		2		3		1		2		3	
	Entrance Speed	Δ Vehicle Orientation	Entrance Speed	Δ Vehicle Orientation	Entrance Speed	Δ Vehicle Orientation	Entrance Speed	Δ Vehicle Orientation	Entrance Speed	Δ Vehicle Orientation	Entrance Speed	Δ Vehicle Orientation
C	80.5 km/h (50.0 mph)	rotated 90°	75.0 km/h (46.6 mph)	rotated 90°	77.4 km/h (48.1 mph)	rotated 90°	81.6 km/h (50.7 mph)	none	81.9 km/h (50.9 mph)	3.0 m (10 ft) out of lane	83.4 km/h (51.8 mph)	rotated 180°
E	83.2 km/h (51.7 mph)	none	80.5 km/h (50.0 mph)	rotated 90°	79.5 km/h (49.4 mph)	none	80.8 km/h (50.2 mph)	none	81.3 km/h (50.5 mph)	none	79.7 km/h (49.5 mph)	none
F	80.3 km/h (49.9 mph)	none	81.9 km/h (50.9 mph)	none	80.5 km/h (50.0 mph)	none	82.7 km/h (51.4 mph)	1.5 m (5 ft) out of lane	80.5 km/h (50.0 mph)	none	81.6 km/h (50.7 mph)	none
H	80.0 km/h (49.7 mph)	none	81.1 km/h (50.4 mph)	none	82.1 km/h (51.0 mph)	none	82.4 km/h (51.2 mph)	rotated 360°	74.4 km/h (46.2 mph)	none	74.2 km/h (46.1 mph)	none
I	81.9 km/h (50.9 mph)	none	82.1 km/h (51.0 mph)	multiple 360° spins	81.8 km/h (50.8 mph)	multiple 360° spins	n/a	n/a	n/a	n/a	n/a	n/a

Note that all single lane change maneuvers were conducted with ABS only.

Unfortunately, there was data from only one test series, comprised of three runs, available to assess the accuracy of this hypothesis. The steering and brake inputs associated with the lightly laden loading condition of vehicle "C" provide only a limited indication as to whether the vehicle would be expected to lose control during a given run (see Figure 21).

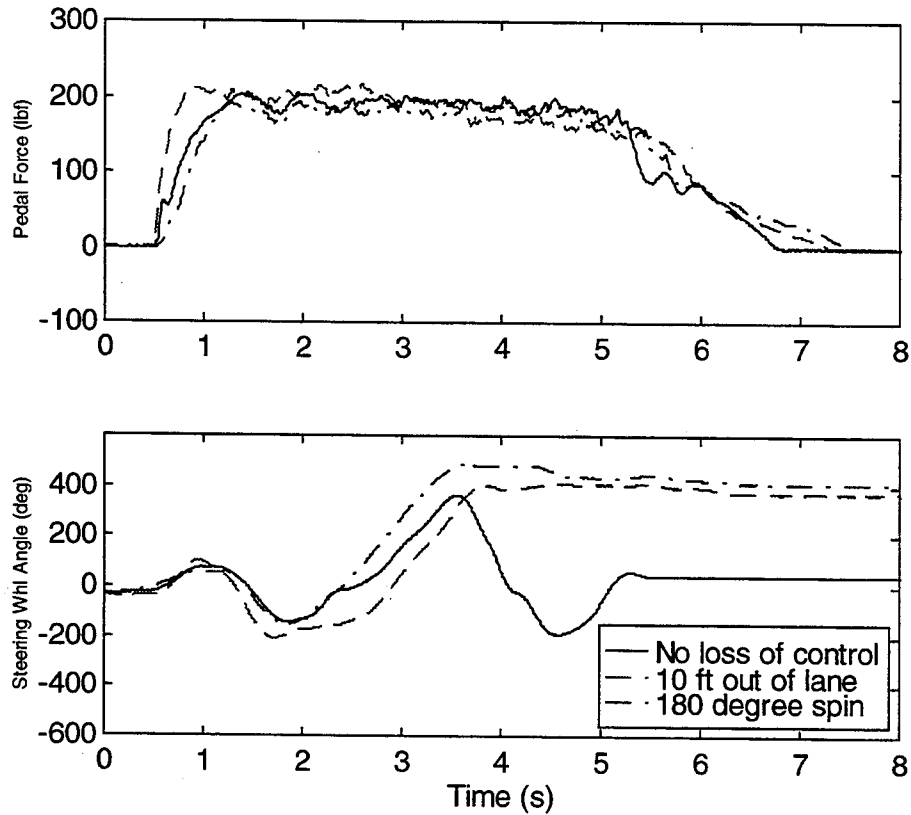

Figure 21. Single lane change driver inputs for test vehicle "C". The vehicle was lightly laden.

The magnitude and rate of the brake application and first steering input of the first run lay within the values of the two later unstable cases. The steering rate of the countersteer input (the steering input that immediately followed the steering reversal) was nearly identical for all three runs, however the magnitude was slightly higher for the run in which the vehicle deviated 3.0 m (10 ft) from its intended stopping lane. The magnitude of this steering input was 170.0° , compared to 103.8° for the first run, and 124.5° for the third. The phasing of the steering input/brake application

was nearly identical for the first two runs, however the brake application lagged the steering input by 0.4 seconds in the third run. This lag may have contributed to the vehicular instability that ultimately resulted in run number three's spin.

Successfully completing the lane change maneuver at one speed yet losing control at another very similar speed was experienced by the test driver with each of the five vehicles listed in Table 5. Due to the absence of appropriate instrumentation, steering input comparisons for vehicles "E", "F", "H", and "I" were not possible. Steering input variability and steering input/brake application phasing are the most probable cause of this phenomenon, however the lack of steering input data prevented further analysis.

6.0 HUMAN FACTORS CONSIDERATIONS

Each test vehicle provided the driver with brake pedal and aural feedback while the ABS was cycling. The test driver would often experience vibration and oscillation of the pedal and easily hear the operation of the solenoid valves and ABS pump motor. The extent to which these signals were in evidence, however, varied from vehicle to vehicle. Even the vehicle whose ABS had virtually transparent pedal feedback (vehicle "G") presented the driver with very apparent aural cues. The point is that in each case, the vehicle "told" the driver the ABS was operating.

What makes this interesting from a human factors standpoint is that the antilock brake systems of some vehicles were found to transmit different cues under different driving conditions. If an ABS was activated on a very low coefficient surface such as epoxy, it would go into a deep cycle to keep wheel slip at an acceptable level. The corresponding pedal feedback, on some vehicles, was much more pronounced during deep cycling and could, potentially, startle an unfamiliar or unsuspecting driver. The result, depending on the severity of the condition necessitating the brake application, could be that the driver lifts their foot and releases the brake pedal. Even if the driver reapplies the brakes, this action will result in dramatically increased stopping distances.

The preliminary results of NHTSA's Light Vehicle ABS Research Program Task 5.2 indicate that braking practice may influence a driver's ability to avoid a collision in a crash imminent situation with ABS. When combined with the fact that ABS brake pedal feedback may vary with respect to road condition, practice may have important implications.

An ABS allows a driver to maintain directional control of their vehicle and enhances vehicular stability while braking, however it requires the driver to maintain positive force on the brake pedal throughout the entire duration of the stop. To prevent the driver from being surprised by ABS behavior and its resulting pedal feedback, if any, drivers should be encouraged to practice ABS braking under many road conditions and maneuvers. Such braking practice, however, should consist of maneuvers compatible with the driver's level of skill.

7.0 CONCLUSION

The results of this study indicate that for most stopping maneuvers, made on most test surfaces, ABS-assisted panic stops were shorter than those made with best effort or full pedal applications with the ABS disabled (see Table 6). Furthermore, the vehicular stability during these stops was almost always found to be superior with ABS. Although it was not specifically quantified in this study, the absence of excessive yaw while braking enhanced the ease at which the driver could maintain lane position, especially when compared to stops made with panic brake applications and the ABS disabled on split-mu and low coefficient surfaces.

Table 6. ABS Performance Summary.

Surface	ABS Stopping Distance Benefit (or Disadvantage) Over the Shortest non-ABS Stop (%)	
	Lightly Laden	Fully Laden
Dry Concrete Straight Line	9.8	12.7
Wet Polished Concrete Straight Line	16.7	23.1
Wet Asphalt Straight Line	11.4	17.2
Wet Jennite Straight Line	17.6*	26.6
Grass Straight Line	(7.1)*	6.9
Loose Gravel Straight Line	(30.0)*	(24.6)
ABS Test Pad #0	7.6	11.6
ABS Test Pad #1	6.2	10.3
ABS Test Pad #2	6.1	10.9
ABS Test Pad #3	4.6*	7.9*
Wet Asphalt/Wet Epoxy Split-mu	11.3	11.4
Dry Asphalt Curve	11.9	19.5
Wet Jennite Curve	18.9*	32.4

*Percentage calculated using eight test vehicles.

The one exception to this trend occurred on the loose gravel surface, where stopping distances with ABS were extended by an overall average of 27.2 percent over the disabled ABS full pedal application stops. The ABS-induced stopping distance increases were recorded for all vehicles at both loading conditions. Braking performance on this surface therefore comprises an area in which future efforts to improve ABS might be focused.

The fact that there exists a condition in which ABS continues to contribute to increased stopping distances (on loose gravel) demonstrates compromises in ABS design still exist. That said, most passenger vehicles spend far more time on smooth, paved roads than they do traveling over “soft” road surfaces like gravel and lightly packed snow.

One way to optimize ABS operation for deformable road surfaces would be to increase the longitudinal wheel slip threshold. This would, however, impede a vehicle’s ability to turn during an ABS-assisted stop, thereby reducing one of the fundamental attributes of ABS—enabling the driver to effectively brake and steer simultaneously. Efforts to resolve this compromise may include the use of advanced roadway surface detection. Evolution of technology in this domain would enable an ABS to adapt its control algorithm to meet a vehicle’s braking/handling demands based on the roadway surface condition. Utilizing such technology, however, must not compromise a driver’s ability to retain directional control of the vehicle.

This study also establishes that antilock brake systems include compromises of stopping distance versus vehicular stability. Most antilock brake systems maintain vehicular stability while braking by minimizing excessive yaw. In a curve, this stability may be created by sacrificing the shortest attainable stopping distance. With this said, most test vehicles (only one exception was observed) were stopped in shorter distances with ABS than with ABS disabled best effort attempts for maneuvers that involved braking and steering (or steering and braking). Under these conditions, ABS prevented wheel lockup and minimized yaw for each of the nine vehicles.

As discussed in the single lane change results, five out of nine vehicles yawed out of control for at least one test run when the driver steered them onto the wet asphalt/wet epoxy split-mu lane. However, the objective of this maneuver was to look for the possible braking performance degradation of ABS equipped vehicles near the limit of lateral adhesion. If the maneuver entrance speed caused a vehicle to exceed its lateral roadholding ability, excessive yaw following the driver's steering reversal would occur. For some runs, the driver was unable to regain control of the vehicle, and the vehicle would spin out. This is not considered to be an ABS deficiency, as ABS cannot create lateral force. Although ABS is designed to reduce the incidence of spinouts, it cannot completely prevent them. Excessive yaw and/or loss of control results still occurred if, for a particular run, the test driver steered so as to exceed the limit of lateral adhesion (i.e., the maneuver demanded more lateral friction from the vehicle than it was able to deliver, with or without ABS).

Unlike most of the other maneuvers used in this program, ABS-assisted braking performance in the single lane change test was not compared with disabled-ABS performance. Therefore results from this maneuver cannot be used to draw conclusions about the performance of ABS versus non-ABS equipped vehicles.

It was not the intent of this study to compare individual vehicles or antilock brake systems to one another. The test matrix was designed to examine the influence ABS has on a given vehicle's braking performance. Individual system comparison would have necessitated multiple samples of test vehicles identical in every way but ABS. Environmental conditions and test surface temperatures would also have been required to be tightly controlled, monitored, and documented throughout the testing time line. Due to the time required for complete instrumentation and the number of vehicles in the test fleet, such an evaluation would not have been possible.

The results of this study are in agreement with previous studies that have shown that ABS increases steering control and often decreases stopping distance. Overall stopping distance improvements (across the nine vehicle test fleet) were seen on all surfaces except loose gravel and, under the lightly laden loading condition, grass. Testing seems to indicate the increase in single

driver run-off-road crashes is not due to deficiencies of ABS hardware. Preliminary investigation of NASS CDS crash reports (Task 3 of NHTSA's Light Vehicle ABS Research Program) shows that crashes occur most often on dry, paved roadways. Test track results, however, revealed that ABS performance was generally superior to disabled ABS performance over these surfaces. The varying brake pedal cues generated during an ABS-assisted stop (observed during testing), and the possible lack of driver familiarity with them, do provide some potentially valuable insight into the problem, however, as noted in section 6.0 of this report.

It should be recognized that the speeds utilized in this study during off-road surface testing were quite low. Antilock brake system performance on these surfaces at elevated speeds may reveal different results than those previously observed. "NHTSA's Light Vehicle ABS Research Program Task 6: Testing the Effects of ABS When Performing Road Recovery Maneuvers" will explore this hypothesis and introduce two new brake-and-steer maneuvers.

We believe this study has established that ABS braking performance deficiencies are not responsible for the apparent increase in ABS-equipped, single-vehicle, run-off-the-road crashes. NHTSA's Light Vehicle ABS Research Program will continue its exploration of all plausible reasons as to why the crash data studies do not show that ABS is improving automobile safety. Tasks 1 through 7 and Task 9 are currently underway, and the results will be forthcoming.

8.0 ACKNOWLEDGMENTS

The authors would like to thank Larry Jolliff for his test driving, Larry Armstrong for vehicle instrumentation, Dave Dashner for data processing, and Thad Gardner for diagram rendering. Their contributions to this study are greatly appreciated.

9.0 REFERENCES

1. Macher, Frank E. "Safety is a Standard, Not An Option," Remarks to Auto Press Association. Detroit, MI. November 12, 1997.
2. Charles Farmer, Adrian Lund, Rebecca Trempel, Elissa R. Braver. "Fatal Crashes of Passenger Vehicles Before and After Adding Antilock Brake Systems." Arlington, VA: Insurance Institute for Highway Safety; 1996
3. Ellen Hertz, Judith Hilton, Delmas Johnson. "An Analysis of the Crash Experience of Passenger Cars Equipped with Antilock Braking Systems," NHTSA Technical Report, DOT HS 808 279, May 1995.
4. Evans, Leonard. "ABS and Relative Crash Risk Under Different Roadway, Weather, and Other Conditions," SAE paper 950353. Warrendale, PA: Society of Automotive Engineers; 1994.
5. Kahane, Charles. "Preliminary Evaluation of the Effectiveness of Antilock Brake Systems for Passenger Cars," NHTSA Technical Report, DOT HS 808 206, December 1994.
6. Ed Hiltner, Chuck Arehart, and Richard Radlinski. "Light Vehicle ABS Performance Evaluation--Phase II," NHTSA Final Report, DOT HS 807 924, May 1992.
7. Ed Hiltner, Chuck Arehart, and Richard Radlinski. "Light Vehicle ABS Performance Evaluation," NHTSA Final Report, DOT HS 807 813, December 1991.
8. American Society for Testing and Materials. "Standard Test Method for Determining Longitudinal Peak Braking Coefficient of Paved Surfaces Using a Standard Reference Test Tire, Section 4--Construction, Vol. 04.03--Road and Paving Materials; Vehicle-Pavement Systems, 1996.
9. American Society for Testing and Materials. "Standard Specification for a Radial Standard Reference Test Tire," 1996 Annual Book of ASTM Standards, Section 4--Construction, Vol. 04.03--Road and Paving Materials; Vehicle-Pavement Systems, 1996.
10. American Society for Testing and Materials. "Standard Test Method for Skid Resistance of Paved Surfaces Using a Full-Scale Tire," 1996 Annual Book of ASTM Standards, Section 4--Construction, Vol. 04.03--Road and Paving Materials; Vehicle-Pavement Systems, 1996.
11. American Society for Testing and Materials. "Standard Specification for Standard Rib Tire for Pavement Skid-Resistance Tests," 1996 Annual Book of ASTM Standards, Section 4--Construction, Vol. 04.03--Road and Paving Materials; Vehicle-Pavement Systems, 1996.

12. Society of Automotive Engineers, Inc. "Stopping Distance Test Procedure--SAE J299 SEP93." 1996 SAE Handbook, Vol. 2--Parts and Components, 1996.

Appendix

Table A1. Test Vehicle Stopping Distances (Lightly Laden).

Vehicle	Dry Concrete			Wet Polished Concrete			Wet Asphalt (Straight Line)			Wet Asphalt (Straight Line)			Grass			Loose Gravel		
	ABS On	Full Pedal	Best Effort	ABS On	Full Pedal	Best Effort	ABS On	Full Pedal	Best Effort	ABS On	Full Pedal	Best Effort	ABS On	Full Pedal	Best Effort	ABS On	Full Pedal	Best Effort
A	41.9	n/a	50.6	30.4	30.0	38.0	53.9	105.6	49.4	12.2	13.3	32.6	24.0	n/a	n/a	n/a	n/a	n/a
B	44.1	n/a	50.1	26.0	31.1	n/a	41.6	99.3	71.7	13.9	10.9	n/a	29.9	21.1	n/a	n/a	n/a	n/a
C	45.1	n/a	48.8	31.1	33.5	n/a	41.4	102.0	62.3	16.5	14.1	n/a	27.3	23.0	n/a	n/a	n/a	n/a
D	41.9	n/a	44.6	28.4	31.1	n/a	31.7	117.0	77.6	13.7	12.7	n/a	31.3	23.3	n/a	n/a	n/a	n/a
E	42.3	n/a	50.3	25.3	31.1	n/a	32.8	93.6	55.8	14.2	12.6	n/a	29.7	23.4	n/a	n/a	n/a	n/a
F	43.9	n/a	46.9	33.0	34.2	n/a	36.8	53.0	61.0	13.0	12.6	n/a	27.8	22.4	n/a	n/a	n/a	n/a
G	43.0	n/a	49.0	35.5	34.8	n/a	40.5	99.2	78.3	15.7	17.3	n/a	32.1	25.3	n/a	n/a	n/a	n/a
H	47.9	n/a	48.6	34.9	33.2	n/a	31.7	96.5	68.1	18.2	16.8	n/a	33.9	25.7	n/a	n/a	n/a	n/a
I	44.1	n/a	49.0	29.4	32.6	n/a	37.7	n/a	n/a	n/a	n/a	n/a	n/a	n/a	n/a	n/a	n/a	n/a

Vehicle	Wet Asphalt			Wet Asphalt			Wet Asphalt			Wet Asphalt			Wet Asphalt			Wet Asphalt			Wet Asphalt			
	ABS On	Full Pedal	Best Effort	ABS On	Full Pedal	Best Effort	ABS On	Full Pedal	Best Effort	ABS On	Full Pedal	Best Effort	ABS On	Full Pedal	Best Effort	ABS On	Full Pedal	Best Effort	ABS On	Full Pedal	Best Effort	
A	30.6	n/a	n/a	32.0	n/a	n/a	24.1	n/a	n/a	19.4	20.5	n/a	21.5	21.9	n/a	21.2	22.3	n/a	21.2	21.6	22.3	n/a
B	25.5	n/a	n/a	22.6	n/a	n/a	26.0	n/a	n/a	19.4	22.2	n/a	21.5	22.5	n/a	21.6	23.0	n/a	21.6	22.9	23.0	n/a
C	37.6	n/a	n/a	27.1	n/a	n/a	29.0	n/a	n/a	20.8	22.3	n/a	22.4	23.8	n/a	22.9	24.4	n/a	22.9	24.4	24.4	n/a
D	31.8	n/a	n/a	28.1	n/a	n/a	24.6	n/a	n/a	19.1	20.1	n/a	20.8	22.9	n/a	21.6	22.9	n/a	21.6	22.9	22.9	n/a
E	33.2	n/a	n/a	25.2	n/a	n/a	26.6	n/a	n/a	20.3	21.6	n/a	23.4	25.1	n/a	24.1	25.1	n/a	24.1	25.1	25.1	n/a
F	38.0	n/a	n/a	25.4	n/a	n/a	26.4	n/a	n/a	20.2	23.9	n/a	23.2	25.8	n/a	24.2	28.5	n/a	24.2	28.5	28.5	n/a
G	34.9	n/a	n/a	30.0	n/a	n/a	29.7	n/a	n/a	22.2	23.8	n/a	23.7	25.4	n/a	24.6	25.1	n/a	24.6	25.1	25.1	n/a
H	39.0	n/a	n/a	29.0	n/a	n/a	31.9	n/a	n/a	23.5	23.5	n/a	25.3	25.9	n/a	26.4	27.2	n/a	26.4	27.2	27.2	n/a
I	n/a	n/a	n/a	n/a	n/a	n/a	28.7	n/a	n/a	21.2	24.0	n/a	23.8	25.6	n/a	23.9	26.2	n/a	23.9	26.2	26.2	n/a

Vehicle	ABS PAD 3			Spill-mu			Dry Asphalt (Curve)			Wet Asphalt (Curve)			J-turn			Single Lane Change					
	ABS On	Full Pedal	Best Effort	ABS On	Full Pedal	Best Effort	ABS On	Full Pedal	Best Effort	ABS On	Full Pedal	Best Effort	ABS On	Full Pedal	Best Effort	ABS On	Full Pedal	Best Effort			
A	22.3	23.6	n/a	21.3	25.4	30.9	33.2	n/a	40.7	61.3	59.1	35.5	n/a	n/a	42.6	n/a	n/a	n/a	n/a	n/a	n/a
B	22.8	23.6	n/a	19.6	21.9	35.8	35.1	n/a	41.7	58.5	75.7	39.8	n/a	n/a	50.5	n/a	n/a	n/a	n/a	n/a	n/a
C	24.2	25.0	n/a	20.1	24.5	32.4	36.5	n/a	50.0	56.6	67.5	45.0	n/a	n/a	53.3	n/a	n/a	n/a	n/a	n/a	n/a
D	22.1	22.4	n/a	18.9	25.8	29.3	30.9	n/a	38.3	56.8	75.9	34.6	n/a	n/a	48.5	n/a	n/a	n/a	n/a	n/a	n/a
E	24.0	24.3	n/a	18.5	23.5	31.2	34.7	n/a	36.9	49.4	60.1	42.4	n/a	n/a	46.2	n/a	n/a	n/a	n/a	n/a	n/a
F	25.8	28.8	n/a	22.2	35.2	32.7	36.5	n/a	43.0	51.5	70.8	46.8	n/a	n/a	55.6	n/a	n/a	n/a	n/a	n/a	n/a
G	25.5	29.6	n/a	24.1	30.3	35.7	34.7	n/a	43.5	61.0	78.7	40.1	n/a	n/a	56.4	n/a	n/a	n/a	n/a	n/a	n/a
H	28.0	27.5	n/a	33.0	25.5	57.6	36.5	n/a	39.4	48.0	62.4	44.3	n/a	n/a	64.5	n/a	n/a	n/a	n/a	n/a	n/a
I	n/a	n/a	n/a	27.0	23.9	34.0	52.8	n/a	43.1	n/a	n/a	43.3	n/a	n/a	n/a	n/a	n/a	n/a	n/a	n/a	n/a

All stopping distances are given in meters.

Table A2. Test Vehicle Stopping Distances (GVWR).

Vehicle	Dry Concrete			Wet Polished Concrete			Wet Asphalt (Straight Line)			Wet Asphalt (Straight Line)			Grass			Loose Gravel		
	ABS On	Full Pedal	Best Effort	ABS On	Full Pedal	Best Effort	ABS On	Full Pedal	Best Effort	ABS On	Full Pedal	Best Effort	ABS On	Full Pedal	Best Effort	ABS On	Full Pedal	Best Effort
A	48.2	n/a	56.5	25.7	n/a	32.1	33.3	n/a	33.7	42.9	61.7	54.3	16.1	20.1	n/a	29.8	22.9	n/a
B	53.3	n/a	64.8	25.9	n/a	38.4	36.5	n/a	41.1	67.9	107.1	91.6	15.5	15.9	n/a	26.9	21.8	n/a
C	46.7	n/a	52.4	24.0	n/a	27.4	34.3	n/a	42.6	49.0	94.5	67.5	15.5	16.5	n/a	29.7	26.4	n/a
D	45.9	n/a	50.7	25.1	n/a	33.7	32.9	n/a	40.9	54.3	98.2	70.0	14.8	15.8	n/a	27.6	22.9	n/a
E	48.5	n/a	53.6	27.1	n/a	33.1	35.1	n/a	40.7	51.9	81.1	65.2	17.7	19.1	n/a	30.0	24.7	n/a
F	48.9	n/a	58.7	27.4	n/a	34.7	34.4	n/a	43.8	50.1	94.0	68.6	15.1	14.4	n/a	30.9	24.1	n/a
G	49.6	n/a	52.9	30.0	n/a	36.8	36.1	n/a	45.6	54.0	77.6	74.2	17.6	18.0	n/a	33.3	25.9	n/a
H	49.6	n/a	52.0	28.6	n/a	42.6	35.9	n/a	39.8	41.6	66.4	65.8	18.3	17.0	n/a	31.0	25.3	n/a
I	48.0	n/a	55.6	25.4	n/a	34.9	36.5	n/a	47.1	59.8	103.4	86.3	23.2	33.1	n/a	34.1	25.5	n/a

Vehicle	Wet Asphalt/Wet Jumble			Wet Asphalt/Wet Asphalt			Wet Asphalt (Curve)			Wet Asphalt (Curve)			Jumbo			Single Lane Change		
	ABS On	Full Pedal	Best Effort	ABS On	Full Pedal	Best Effort	ABS On	Full Pedal	Best Effort	ABS On	Full Pedal	Best Effort	ABS On	Full Pedal	Best Effort	ABS On	Full Pedal	Best Effort
A	29.9	n/a	n/a	28.4	n/a	n/a	27.3	n/a	n/a	20.8	23.7	n/a	22.1	24.7	n/a	22.3	24.7	n/a
B	34.4	n/a	n/a	25.7	n/a	n/a	29.5	n/a	n/a	21.8	25.9	n/a	23.6	27.1	n/a	22.9	27.1	n/a
C	33.1	n/a	n/a	26.3	n/a	n/a	27.8	n/a	n/a	21.8	25.1	n/a	22.9	25.9	n/a	23.1	25.1	n/a
D	30.1	n/a	n/a	27.2	n/a	n/a	24.9	n/a	n/a	20.4	23.4	n/a	23.5	25.1	n/a	22.0	24.0	n/a
E	36.2	n/a	n/a	27.4	n/a	n/a	26.1	n/a	n/a	21.8	24.2	n/a	23.6	26.2	n/a	24.3	26.4	n/a
F	36.4	n/a	n/a	27.0	n/a	n/a	27.2	n/a	n/a	23.2	26.3	n/a	25.0	27.9	n/a	24.7	28.6	n/a
G	32.8	n/a	n/a	28.1	n/a	n/a	29.0	n/a	n/a	21.9	25.1	n/a	21.9	26.4	n/a	24.1	28.9	n/a
H	39.8	n/a	n/a	29.8	n/a	n/a	33.2	n/a	n/a	23.2	25.7	n/a	26.5	29.7	n/a	26.6	29.6	n/a
I	36.9	n/a	n/a	30.7	n/a	n/a	30.6	n/a	n/a	22.9	24.1	n/a	24.0	24.8	n/a	23.9	26.1	n/a

Vehicle	ABS PADS			Soft, MU			Dry Asphalt (Curve)			Wet Asphalt (Curve)			Jumbo			Single Lane Change		
	ABS On	Full Pedal	Best Effort	ABS On	Full Pedal	Best Effort	ABS On	Full Pedal	Best Effort	ABS On	Full Pedal	Best Effort	ABS On	Full Pedal	Best Effort	ABS On	Full Pedal	Best Effort
A	23.3	26.0	n/a	20.5	21.1	21.1	31.9	46.4	n/a	47.5	48.2	59.7	35.8	n/a	n/a	40.2	n/a	n/a
B	25.7	26.9	n/a	19.0	25.0	37.7	37.7	37.5	n/a	45.8	59.8	89.5	43.0	n/a	n/a	55.2	n/a	n/a
C	24.2	25.8	n/a	23.0	30.2	39.0	39.0	37.5	n/a	56.0	45.7	68.3	41.8	n/a	n/a	60.5	n/a	n/a
D	22.6	25.2	n/a	20.5	21.7	32.4	32.5	32.5	n/a	48.1	46.5	65.1	35.9	n/a	n/a	44.4	n/a	n/a
E	25.6	27.2	n/a	19.8	25.9	29.9	29.9	35.7	n/a	50.7	53.2	80.0	46.4	n/a	n/a	45.5	n/a	n/a
F	27.6	29.3	n/a	23.6	35.1	30.9	38.4	38.4	n/a	52.0	51.6	74.0	40.6	n/a	n/a	54.2	n/a	n/a
G	26.7	31.8	n/a	24.2	28.8	42.2	36.9	36.9	n/a	52.1	55.5	81.0	45.9	n/a	n/a	57.8	n/a	n/a
H	29.1	30.2	n/a	36.8	31.6	73.5	42.1	42.1	n/a	49.7	49.0	79.0	49.0	n/a	n/a	75.7	n/a	n/a
I	n/a	n/a	n/a	24.4	24.2	35.6	58.9	58.9	n/a	52.9	42.5	93.4	64.5	n/a	n/a	74.2	n/a	n/a

All stopping distances are given in meters.

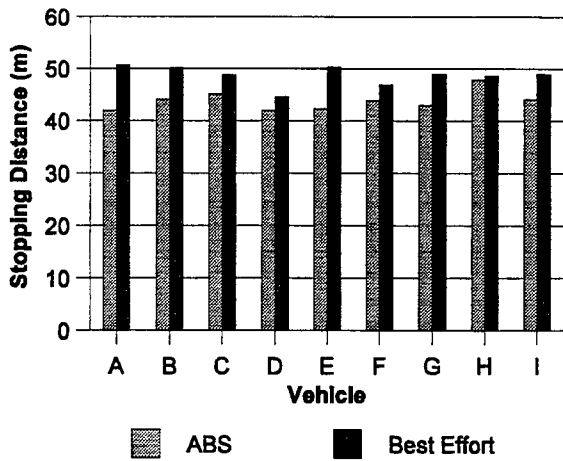

Figure A1. Straight line stopping distances observed on dry concrete. Test vehicles were lightly laden. Test speed was 97 km/h (60 mph).

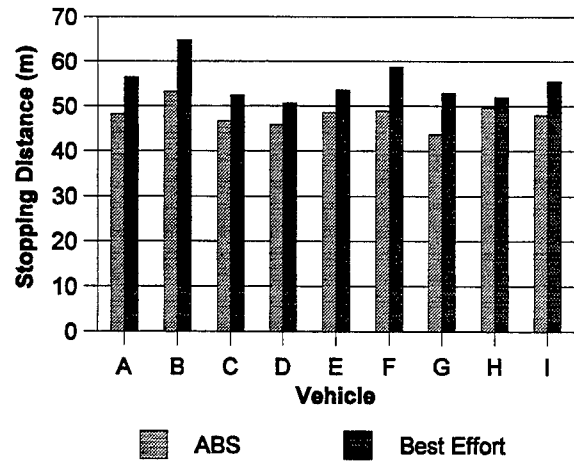

Figure A2. Straight line stopping distances observed on dry concrete. Test vehicles were fully laden to their respective GVWRs. Test speed was 97 km/h (60 mph).

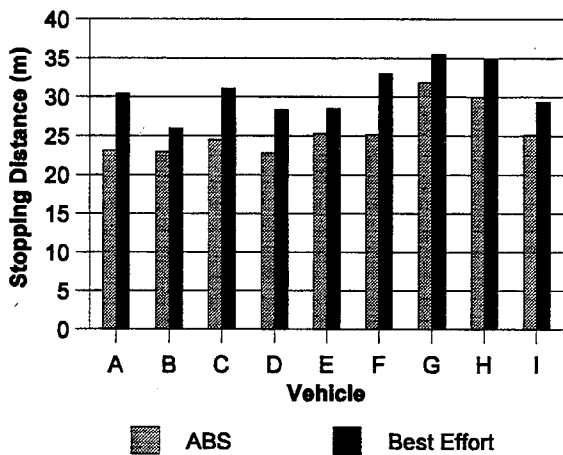

Figure A3. Straight line stopping distances observed on wet polished concrete. Test vehicles were lightly laden. Test speed was 64 km/h (40 mph).

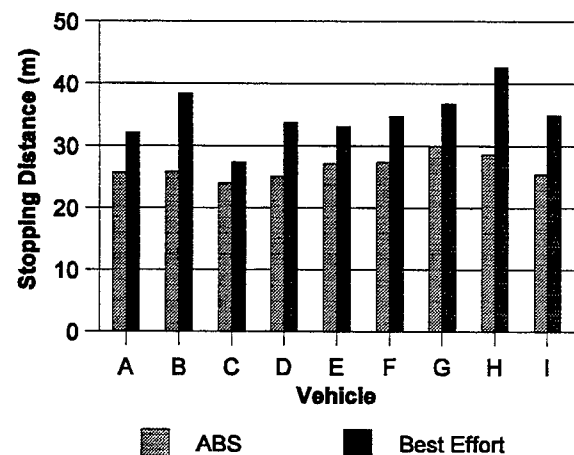

Figure A4. Straight line stopping distances observed on wet polished concrete. Test vehicles were fully laden to their respective GVWRs. Test speed was 64 km/h (40 mph).

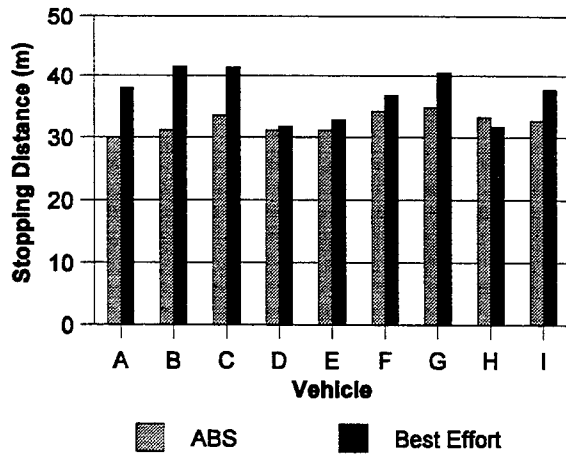

Figure A5. Straight line stopping distances observed on wet asphalt. Test vehicles were lightly laden. Test speed was 80 km/h (50 mph).

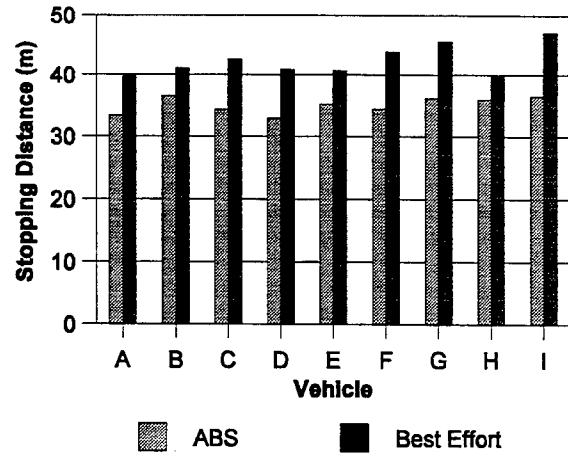

Figure A6. Straight line stopping distances observed on wet asphalt. Test vehicles were fully laden to their respective GVWRs. Test speed was 80 km/h (50 mph).

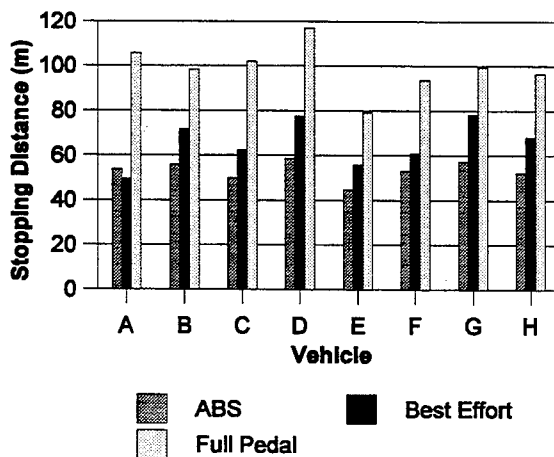

Figure A7. Straight line stopping distances observed on wet Jennite. Test vehicles were lightly laden. Test speed was 64 km/h (40 mph). Vehicle "T" braking performance was not evaluated.

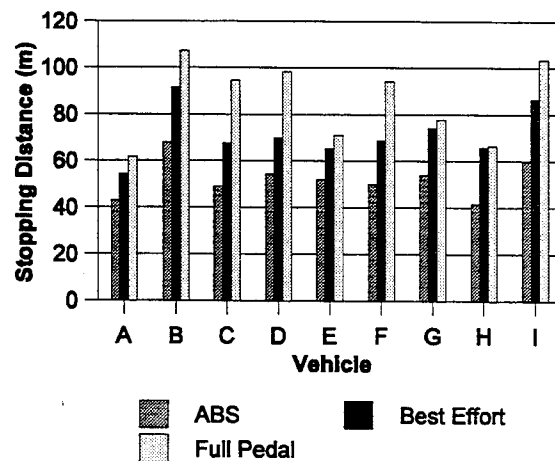

Figure A8. Straight line stopping distances observed on wet Jennite. Test vehicles were fully laden to their respective GVWRs. Test speed was 64 km/h (40 mph).

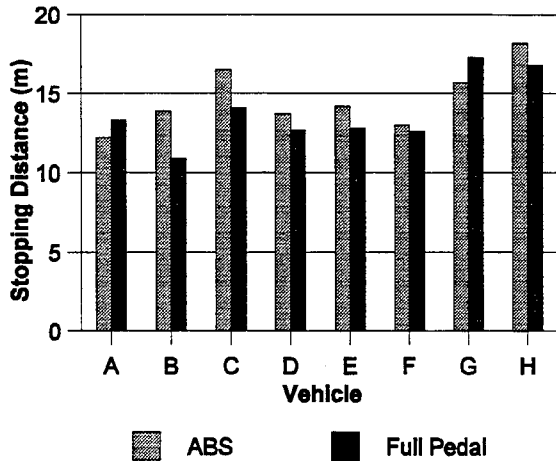

Figure A9. Straight line stopping distances observed on grass. Test vehicles were lightly laden. Vehicle “T” braking performance was not evaluated. Test speed was 40 km/h (25 mph).

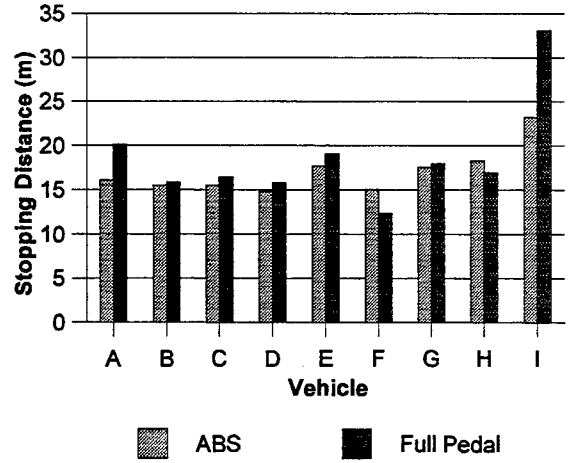

Figure A10. Straight line stopping distances observed on grass. Test vehicles were fully laden to their respective GVWRs. Test speed was 40 km/h (25 mph). Note: the grass was very wet when the braking performance of vehicle “T” was evaluated.

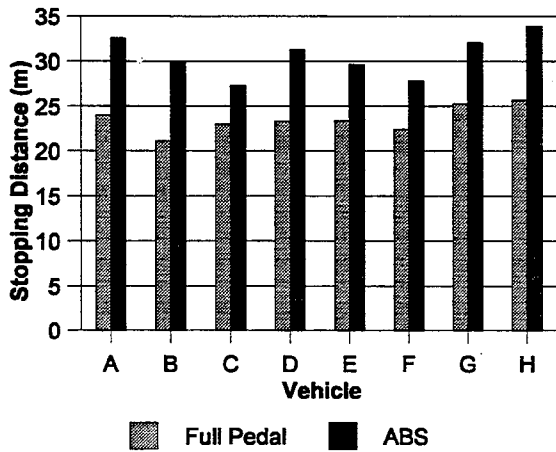

Figure A11. Straight line stopping distances observed on loose gravel. Test vehicles were lightly laden. Test speed was 56 km/h (35 mph). Vehicle “T” braking performance was not evaluated.

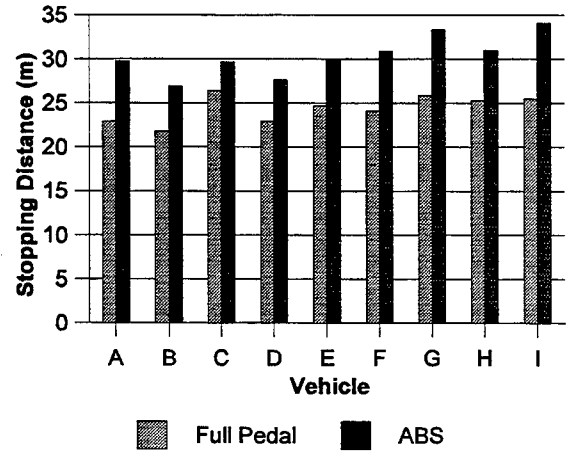

Figure A12. Straight line stopping distances observed on loose gravel. Test vehicles were fully laden to their respective GVWRs. Test speed was 56 km/h (35 mph). Note: the gravel was wet when the braking performance of vehicle “T” was evaluated.

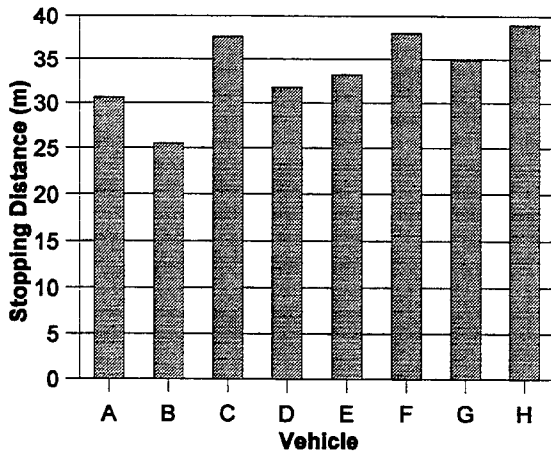

Figure A13. Straight line stopping distances observed on the wet asphalt/wet Jennite transition surface. Test vehicles were lightly laden. Test speed was 64 km/h (40 mph) at the maneuver entrance gate and 40 km/h (25 mph) at the transition. Vehicle “T” braking performance was not evaluated.

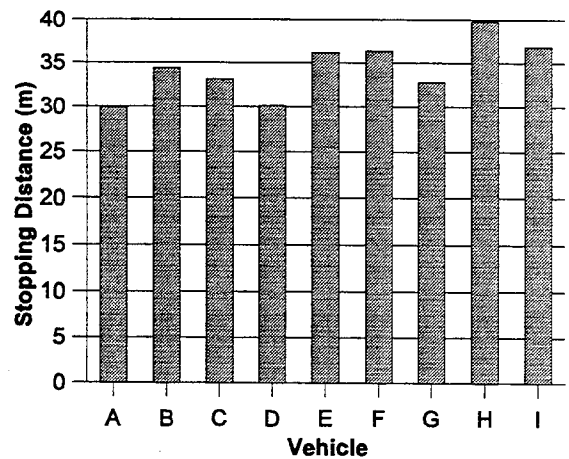

Figure A14. Straight line stopping distances observed on the wet asphalt/wet Jennite transition surface. Test vehicles were fully laden to their GVWRs. Test speed was 64 km/h (40 mph) at the maneuver entrance gate and 40 km/h (25 mph) at the transition.

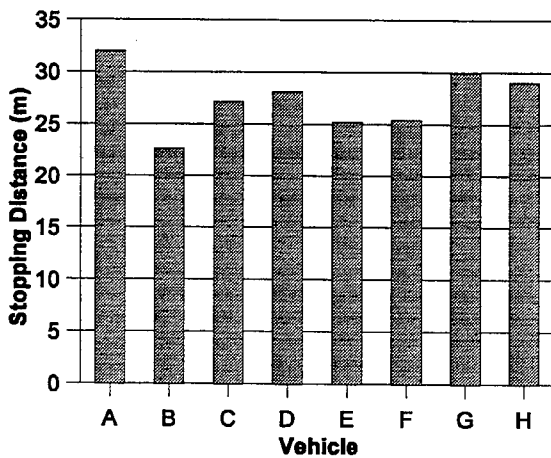

Figure A15. Straight line stopping distances observed on the wet Jennite/wet asphalt transition surface. Test vehicles were lightly laden. Test speed was 56 km/h (35 mph) at the maneuver entrance gate and 40 km/h (25 mph) at the transition. Vehicle “T” braking performance was not evaluated.

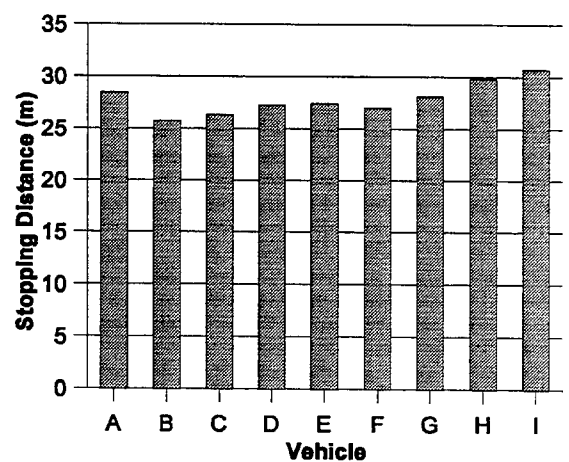

Figure A16. Straight line stopping distances observed on the wet Jennite/wet asphalt transition surface. Test vehicles were fully laden to their respective GVWRs. Test speed was 56 km/h (35 mph) at the maneuver entrance gate and 40 km/h (25 mph) at the transition.

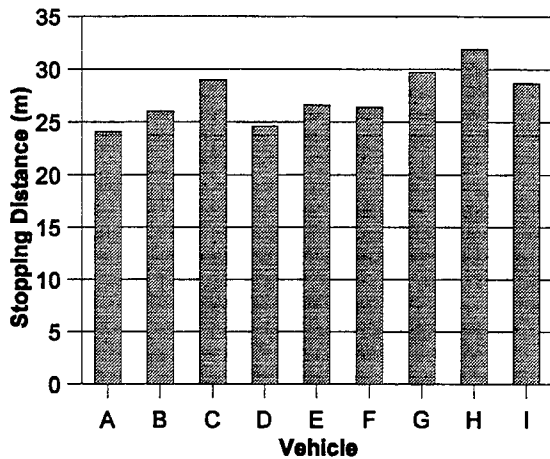

Figure A17. Straight line stopping distances observed on the wet Jennite/wet epoxy/wet asphalt transition surface. Test vehicles were lightly laden. Test speed was 64 km/h (40 mph) at the maneuver entrance gate and 40 km/h (25 mph) at the transition. Note: the epoxy surface was reconditioned prior to the brake performance evaluation of vehicles “H” and “I”.

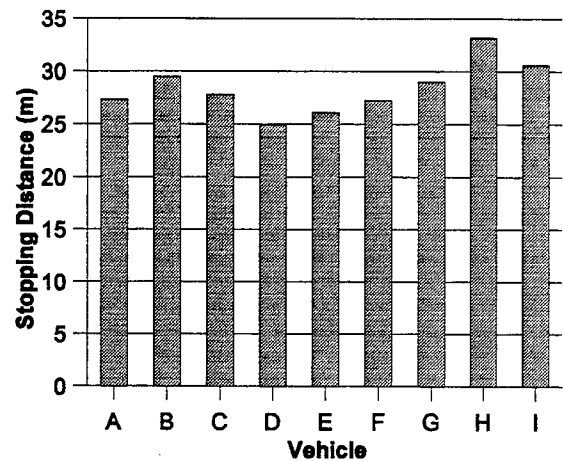

Figure A18. Straight line stopping distances observed on the wet Jennite/wet epoxy/wet asphalt transition surface. Test vehicles were fully laden to their respective GVWRs. Test speed was 64 km/h (40 mph) at the maneuver entrance gate and 40 km/h (25 mph) at the transition. Note: the epoxy surface was reconditioned prior to the brake performance evaluation of vehicles “H” and “I”.

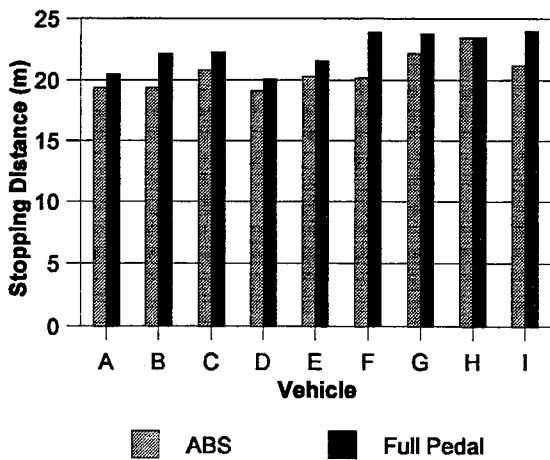

Figure A19. Straight line stopping distances observed on ABS Test Pad #0 (wet). Test vehicles were lightly laden. Test speed was 64 km/h (40 mph).

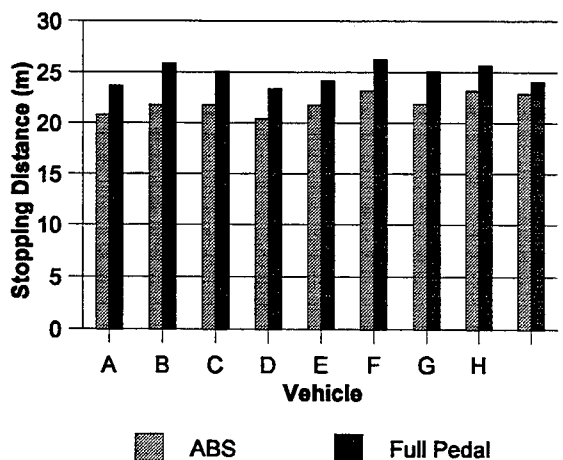

Figure A20. Straight line stopping distances observed on ABS Test Pad #0 (wet). Test vehicles were fully laden to their respective GVWRs. Test speed was 64 km/h (40 mph).

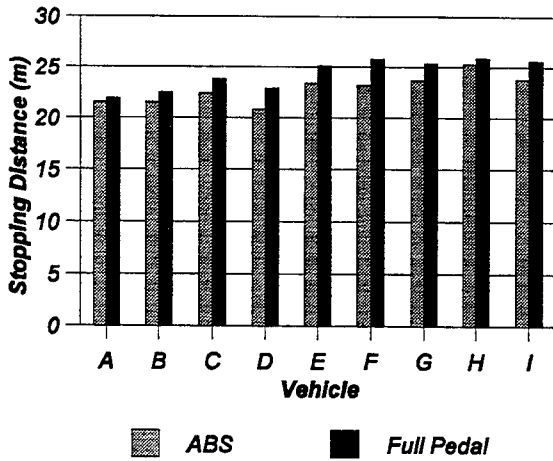

Figure A21. Straight line stopping distances observed on ABS Test Pad #1 (wet). Test vehicles were lightly laden. Test speed was 64 km/h (40 mph).

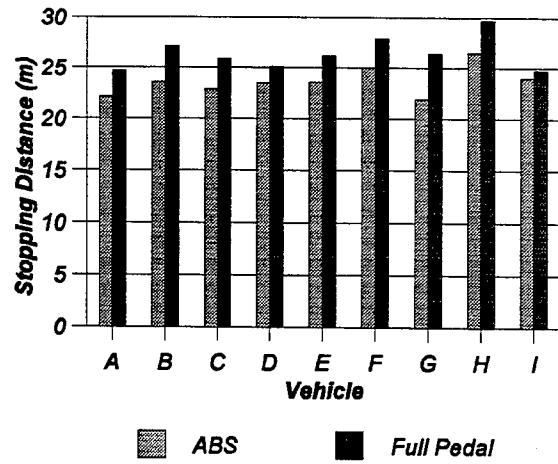

Figure A22. Straight line stopping distances observed on ABS Test Pad #1 (wet). Test vehicles were fully laden to their respective GVWRs. Test speed was 64 km/h (40 mph).

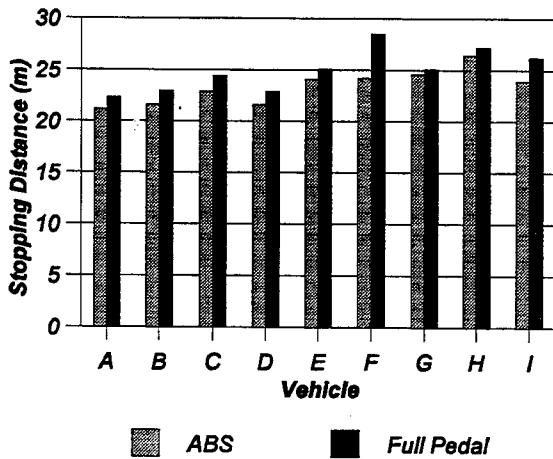

Figure A23. Straight line stopping distances observed on ABS Test Pad #2 (wet). Test vehicles were lightly laden. Test speed was 64 km/h (40 mph).

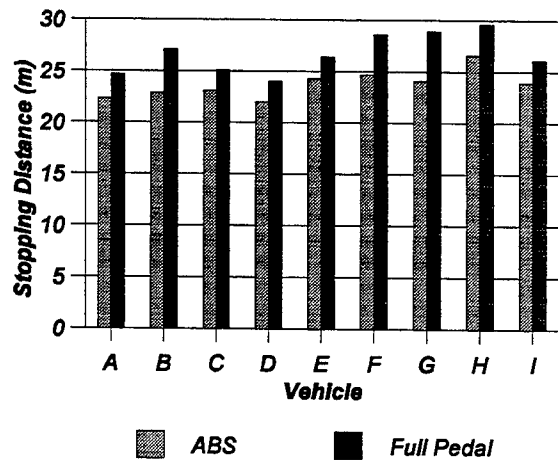

Figure A24. Straight line stopping distances observed on ABS Test Pad #2 (wet). Test vehicles were fully laden to their respective GVWRs. Test speed was 64 km/h (40 mph).

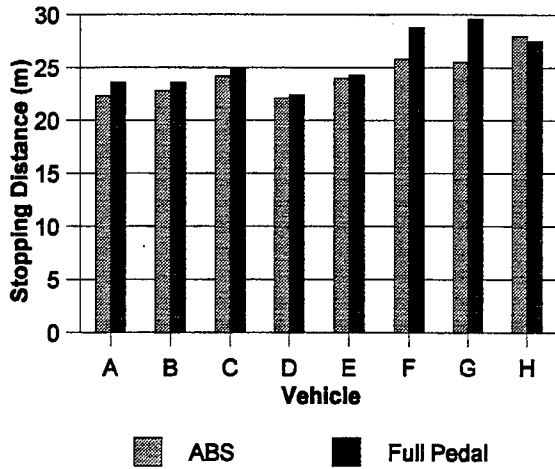

Figure A25. Straight line stopping distances observed on ABS Test Pad #3 (wet). Test vehicles were lightly. Test speed was 64 km/h (40 mph). Vehicle “T” braking performance was not evaluated.

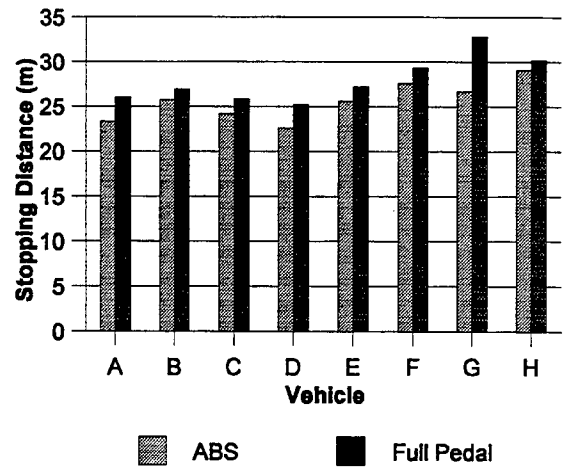

Figure A26. Straight line stopping distances observed on ABS Test Pad #3 (wet). Test vehicles were fully laden to their respective GVWRs. Test speed was 64 km/h (40 mph). Vehicle “T” braking performance was not evaluated.

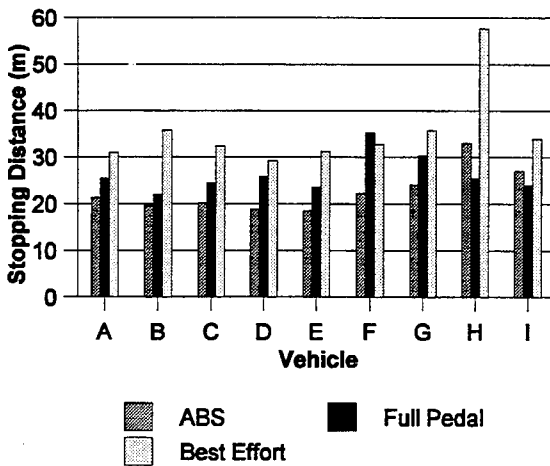

Figure A27. Straight line stopping distances observed on the wet asphalt/wet epoxy split-mu surface. Test vehicles were lightly laden. Test speed was 48 km/h (30 mph). Note: the epoxy surface was reconditioned prior to the brake performance evaluation of vehicles “H” and “T”.

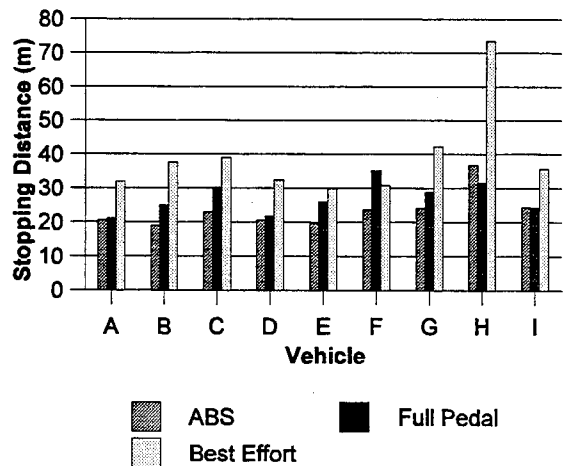

Figure A28. Straight line stopping distances observed on the wet asphalt/wet epoxy split-mu surface. Test vehicles were fully laden to their respective GVWRs. Test speed was 48 km/h (30 mph). Note: the epoxy surface was reconditioned prior to the brake performance evaluation of vehicles “H” and “T”.

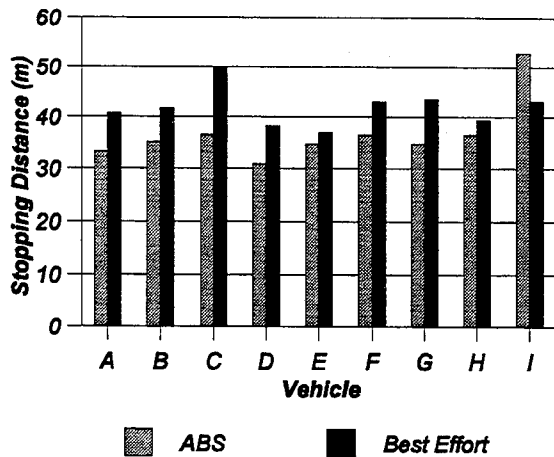

Figure A29. Stopping distances observed on the 91.4 m (300 ft) radius dry asphalt curve. Test vehicles were lightly laden. Test speed was 80 km/h (50 mph).

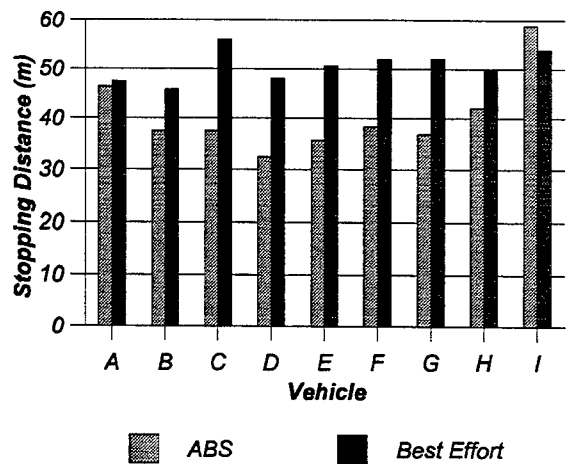

Figure A30. Stopping distances observed on the 91.4 m (300 ft) radius dry asphalt curve. Test vehicles were fully laden to their respective GVWRs. Test speed was 80 km/h (50 mph).

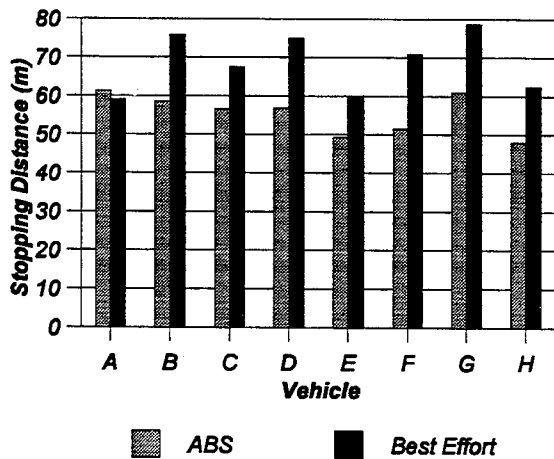

Figure A31. Stopping distances observed on the 152.4 m (500 ft) wet Jennite curve. Test vehicles were lightly laden. Test speed was 64 km/h (40 mph). Vehicle "T" braking performance was not evaluated.

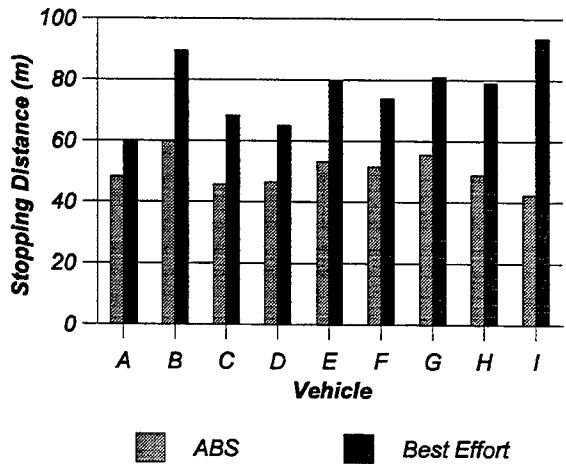

Figure A32. Stopping distances observed on the 152.4 m (500 ft) wet Jennite curve. Test vehicles were fully laden to their respective GVWRs. Test speed was 64 km/h (40 mph).

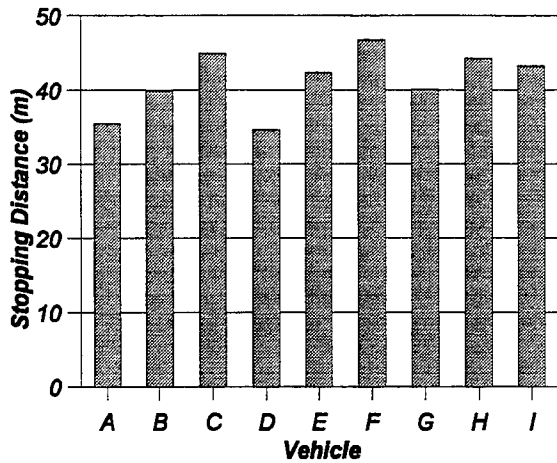

Figure A33. J-turn stopping distances observed on dry asphalt. Test vehicles were lightly laden. Test speed was 80 km/h (50 mph).

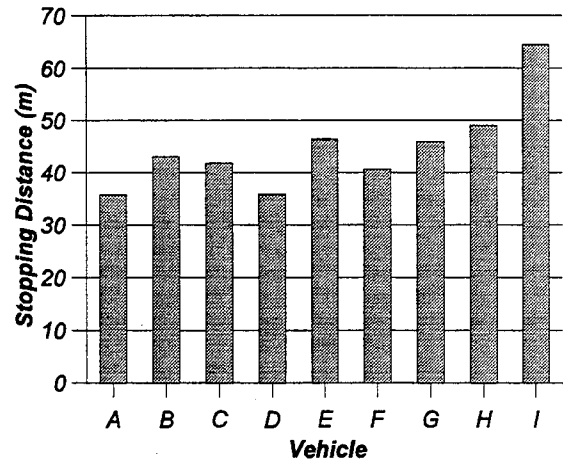

Figure A34. J-turn stopping distances observed on dry asphalt. Test vehicles were fully laden to their respective GVWRs. Test speed was 80 km/h (50 mph).

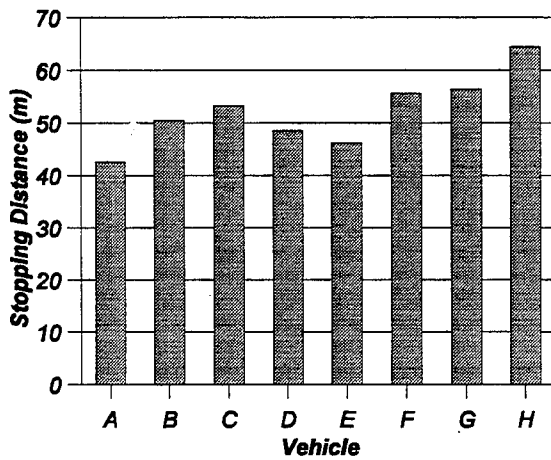

Figure A35. Wet asphalt to wet asphalt/wet epoxy split-mu single lane change stopping distances. Test vehicles were lightly laden. Test speed was 80 km/h (50 mph). Vehicle "I" braking performance was not evaluated. Note: the epoxy surface was reconditioned prior to the brake performance evaluation of vehicle "H".

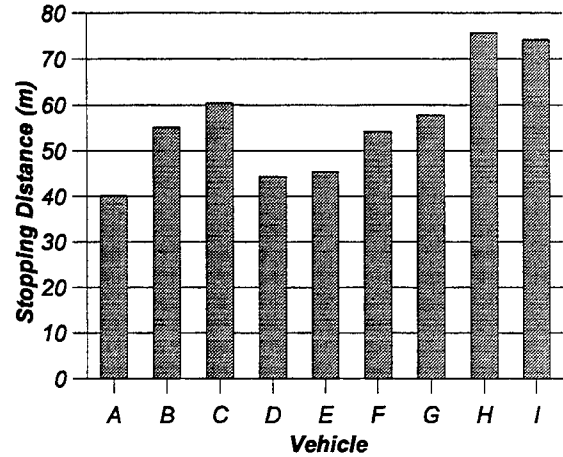

Figure A36. Wet asphalt to wet asphalt/wet epoxy split-mu single lane change stopping distances. Test vehicles were fully laden to their respective GVWRs. Test speed was 80 km/h (50 mph). Note: the epoxy surface was reconditioned prior to the brake performance evaluation of vehicles "H" and "I".

