

Cooperative Agreement No. DTNH22-270 16:

“Human Factors Studies for the  
Evaluation, Analysis, and Operational Assessment of an  
Intelligent Cruise Control System”

A Report on the First Year’s Activities:

MANUAL HEADWAY CONTROL EXPERIMENTS CONDUCTED UNDER  
TEST TRACK AND OPEN ROAD DRIVING CONDITIONS

Ford Motor Company, AVT  
Systems Technology, Inc.

March 1996



|  |                                      |   |           |
|--|--------------------------------------|---|-----------|
| 1. Report No.  | 2. Government Accession No.          | 3. Recipient's Catalog NO.                          |           |
| 4. Title and Subtitle<br>Manual Headway Control Experiments Conducted Under Test<br>Track and Open Road Driving Conditions   |                                      | 5. Report Date<br>April 1996                        |           |
| 7* Author(&. Wade Allen, Steve Eckert, Ray Magdaleno, Tom Sieja,<br>Colleen Serafin and Gretchen Zoebel  |                                      | 6. Performing Organization Code                     |           |
| 9. Performing Organization Name and Address<br>Ford Motor Company Advanced Vehicle Technology  |                                      | 8. Performing Organization Report NO.<br>TR-2496- 1 |           |
| 2. Sponsoring Agency Name and Address<br>U.S. Department of Transportation<br>National Highway Traffic Safety Administration<br>Washington, DC 20590   |                                      | 10. Work Unit No.                                   |           |
| 5. Supplementary Notes   |                                      | 11. Contract or Grant No.<br>DTNH22-27016           |           |
| 6. Abstract  |                                      | 13. Type of Report and Period Covered               |           |
| <p>This report documents a series of experiments designed to identify the dynamic behavior of drivers controlling headway behind a lead vehicle. The experiments were performed on both a test track and the open highway. Time series were recorded during relatively periods of vehicle following. The main recorded variables included headway distance to the lead vehicle, following vehicle velocity, and driver throttle activity. FFT (Fast Fourier Transform) analysis procedures were used to identify transfer functions of driver/vehicle response to changes in headway distance with respect to the lead vehicle.</p> <p>Transfer function analysis allowed the identification of driver gain and time delay in manual headway control. The results showed that manual headway control is a low bandwidth process carried out with average, continuous control time delays on the order of seconds. Phase margins showed the headway control process tends to be under damped (i.e. somewhat oscillatory) with bandwidths on the order one-third of a radian per second (0.05 Hz). This identification of the coupling dynamics of manual headway control will be useful in setting desirable automatic headway control (Intelligent Cruise Control) system characteristics.</p> |                                      | 14. Sponsoring Agency Code<br>Final Report          |           |
| . Key Words (Suggested by Author(s))<br><br>Manual Headway Control, Driver Headway Control,<br>Driver Speed Control, Driver Following Behavior,<br>Headway Control Models  |                                      | 18. Distribution Statement                          |           |
| Security Clauif. (of this report)  | 20. Security Classif. (of this page) | 21. No. of Pages                                    | 22. Price |

## TABLE OF CONTENTS

|  |      |
|--|------|
| A. INTRODUCTION .....  | 1    |
| B. BACKGROUND .....  | 1    |
| C. HEADWAY CONTROL MODELS .....                                      | 1    |
| 1. Crossover Model .....   | 1    |
| 2. Extended Crossover Model .....                                    | 2    |
| 3. Detailed Model .....  | 2    |
| D. TEST TRACK EXPERIMENT .....                                       | 5    |
| 1. Methods and Procedures .....                                      | 5    |
| 2. Results .....   | 8    |
| 3. Dynamic Analysis .....  | 8    |
| E. OPEN ROAD EXPERIMENT .....  | 15   |
| 1. Methods and Procedures .....                                      | 15   |
| 2. Results .....   | 15   |
| F. DISCUSSION .....  | 21   |
| G. IMPLICATIONS FOR FURTHER RESEARCH .....                           | 27   |
| REFERENCES .....   | 28   |
| APPENDIX A. SUBJECT INFORMED CONSENT FORM .....                      | A-1  |
| APPENDIX B. BIOGRAPHICAL DATA FOR .....                              | B: 1 |
| APPENDIX C. SUBJECT INSTRUCTIONS .....                               | C-1  |
| APPENDIX D. DRIVER-VEHICLE PARAMETER IDENTIFICATION PROCEDURES ..... | D-1  |

## LIST OF FIGURES

|  |    |
|--|----|
| Figure 1. Simple Speed Control Model (Bekey, Dumham and Seo, 1977).....  | 3  |
| Figure 2. Extended Crossover Vehicle Following Model.....  | 3  |
| Figure 3. Detailed Car Following Model with Driver and Vehicle Dynamics .....  | 4  |
| Figure 4. Low Speed Test Track at the Ford Dearborn Proving Grounds .....  | 6  |
| Figure 5. Lead Vehicle Speed Profile for Test Track Experiment .....   | 7  |
| Figure 6. Data Time Histories for a typical Test Track Run.....  | 9  |
| Figure 7. FFT Analysis of Figure 6 Time Data.....  | 10 |
| Figure 8. Driver Measured Crossover Model Parameters from Ford Test Track<br>Experiment as a Function of Headway Time .....    | 12 |
| Figure 9. Vehicle Longitudinal Response Transfer Function Detailed Model Identification .....                                  | 14 |
| Figure 10. Driver/Vehicle Detailed Car Following Model Identification .....  | 16 |
| Figure 11. Driver/Vehicle Detailed Model Dynamic Response Analysis.....  | 17 |
| Figure 12. Driving Route Characteristics for UMTRI Open Road Experiment .....  | 18 |
| Figure 13. Raw Time Histories from UMTRI Data Base.....  | 19 |
| Figure 14. UMTRI Data Segment Used in Spectral Analysis .....  | 20 |
| Figure 15. Example Spectral Analysis for UMTRI Data.....   | 22 |
| Figure 16. Open-Loop and Closed-Loop Driver/Vehicle Transfer Functions from UMTRI<br>Data Base.....                            | 23 |
| Figure 17. Driver Measured Crossover Model Parameters from UMTRI Open Highway<br>Experiment as a Function of Headway Time..... | 25 |

## LIST OF TABLES

|   |    |
|---|----|
| Table 1. Headway and Crossover Model Data for Ford Test Track Experiment . . . . .  | 11 |
| Table 2. Ford Test Track Experiment: Multiple Regression Analysis of Crossover<br>Parameter Dependency on Headway Time . . . . .    | 13 |
| Table 3. UMTRI Open Highway Experiment Headway and Crossover Frequency Data . . . . .   | 24 |
| Table 4. UMTRI Open Highway Experiment: Multiple Regression Analysis of Crossover<br>Parameter Dependency on Headway Time . . . . . | 26 |

## A. INTRODUCTION

This working paper describes the conduct and findings of an experiment on manual headway control designed to determine the coupling dynamics between lead and following vehicles. This work was conducted as part of a project on “Human Factors Studies for the Design, Analysis and Deployment of an Intelligent Cruise Control System.” This project is conducted under a Discretionary Cooperative Agreement between the NHTSA and the Ford Motor Co. to foster the development, evaluation, and deployment of collision Avoidance systems.

This first experiment was conducted to determine typical driver behavior during manual car following. The motivation for this experiment was a desire to understand typical driver car following behavior as a guide for setting the automatic control characteristics of an ICC (Intelligent Cruise Control) system. These results are intended to provide a context for subsequent experiments on driver reaction to the design of the dynamic coupling of ICC automatic headway control systems.

## B. BACKGROUND

Past research has dealt with driver headway control models and measurements of driver behavior, Pipes (1957) carried out fundamental work in this area, and Bekey and his students at USC provided a useful summary of past work and further analysis on the general problem of driver lead car following (Bekey, et al., 1977). The models assumed that during car following the driver attempts to minimize velocity differences with a lead vehicle (i.e. a well define stimulus) as illustrated in the Figure 1 compensatory structure where the command speed input is the lead car velocity.

Data collected by others (Chandler, 1958) has shown that the driver can be characterized according the Figure 1 model by a gain (crossover frequency or bandwidth) of 0.37 rad/sec and a time delay of 1.5 seconds. Note that this bandwidth is a factor of 10 slower than compensatory steering bandwidth (e.g. Allen, 1985). Torf and Duckstein (1966) also have collected data on driver detection times for several levels of lead car acceleration. They found Detection times of 1.9 seconds for a lead car acceleration of 2.5 ft/sec<sup>2</sup>, and 2.5 seconds at an acceleration of 1.6 ft/sec<sup>2</sup>. By regression analysis they also determined that response time decreased by 0.8 seconds for each increase of 1 ft/sec<sup>2</sup> in lead car acceleration. This probably relates to the amount of time required to sense a velocity change (i.e. higher accelerations give more rapid change in lead car range and range rate).

## C. HEADWAY CONTROL MODELS

The objective of this project is to define the dynamic coupling that occurs with a lead vehicle under manual lead vehicle following conditions. This objective can be achieved by dynamic analysis of Ford headway control experimental data using FFT (Fast Fourier Transform) procedures. Modeling procedures base on FFT data are as follows.

### 1. Crossover Model

The Figure 1 model can be categorized as a crossover model, wherein the driver/vehicle response is simplified to a gain, time delay and a pure integration. The driver’s compensatory behavior in speed and steering control tasks is designed to minimize error and also to maintain control stability. This behavior can be somewhat complicated, including anticipatory and smoothing compensation for vehicle dynamics characteristics. If we consider the combined behavior of the human operator and vehicle, however, compensatory behavior in manual control systems has been compactly characterized by two parameters, a gain or crossover frequency ( $\omega_c$ ) and a time delay ( $\tau_e$ ) (McRuer and Krendal, 1974).

In the crossover model characterization of manual control system dynamic behavior, crossover frequency is a measure of the system (driver/vehicle) bandwidth, and the product of crossover frequency and time delay is a measure of system damping:

$$\text{Crossover Frequency} = \omega_c \approx \text{Bandwidth}$$

$$\text{Phase Margin (system damping)} = \phi_M = \pi/2 - \omega_c(\text{rad/sec}) \times \tau_c(\text{sec})$$

When Phase Margin goes to zero, the system becomes unstable. When Phase Margin goes much below unity (1.0 radian or about 60 degrees), the system response is oscillatory.

The crossover model is a convenient means for simply characterizing manual control system behavior that can easily be derived from FFT transfer function data. Even though we may postulate more complicated engineering control system models such as below, the crossover model provides a simple basis for summarizing the dynamic behavior of a compensatory system. These two key parameters, crossover frequency ( $\omega_c$ ) and phase margin ( $\phi_M$ ) provide a means for characterizing the bandwidth and damping of the closed loop manual control system that can be conveniently statistically analyzed to provide a summary of typical behavior and variation across a group of subjects.

## 2. Extended Crossover Model

The above simple crossover model can be extended to include maintenance of a desired headway as illustrated in Figure 2. Here, a command feedforward for headway has been added with the additional parameter  $a$  which is low frequency (i.e. long time constant) effect. The extended crossover model controls to minimize velocity errors ( $V_e$ ) just as with the simple crossover model. In addition, the extended crossover model also develops an additional headway error term ( $R_e$ ) which is also minimized, but at a much slower rate than the velocity errors.

The extended crossover model has a bandwidth that is approximately equal to the simple crossover model. Because of the higher frequency dynamics of the low frequency  $a$  term the phase margin now has an extra component:

$$\text{Phase Margin} = \phi_M = \pi/2 - \omega_c(\text{rad/sec}) \times \tau_c(\text{sec}) - \alpha(\text{rad/sec}) / \omega_c$$

This extra phase component allows a simple means for identifying the  $a$  parameter in transfer function phase data.

## 3. Detailed Model

Figure 3 shows the details of a computer model of a driver and a vehicle being controlled. In this model the driver attempts to maintain some following distance behind a lead vehicle in the face of velocity changes of that vehicle just as with the extended crossover model above. In the Figure 3 model the driver responds to changes in range and range rate to the lead vehicle, in addition to a trim function in a form that is often referred to in the control engineering literature as a PID (proportional, integral, differential) controller. The detailed model allows for additional driver dynamic behavior over the extended crossover model, and also allows for longitudinal dynamics of the following vehicle.

Parameters for the Figure 3 model can be derived from FFT transfer function data by system identification procedures. These procedures match an analytical transfer function model to the FFT data by varying the parameters to minimize an error function (the vector error between the FFT and model weighted

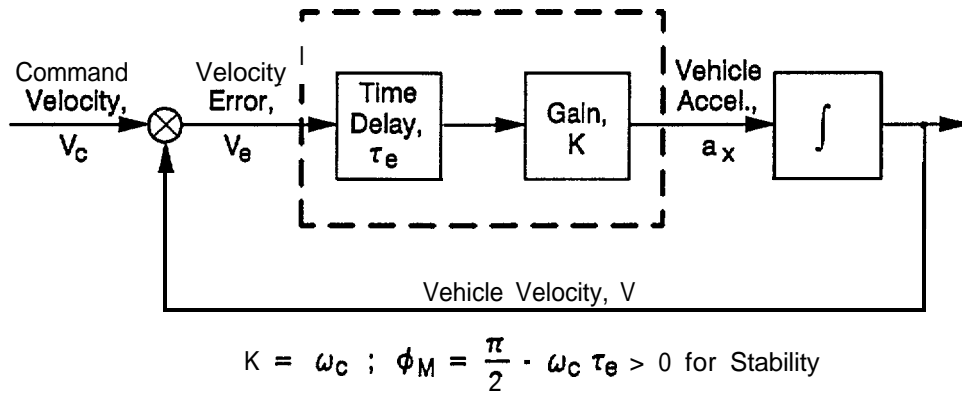

Figure 1. Simple Speed Control Model  
(Bekey, Burnham and Seo, 1977)

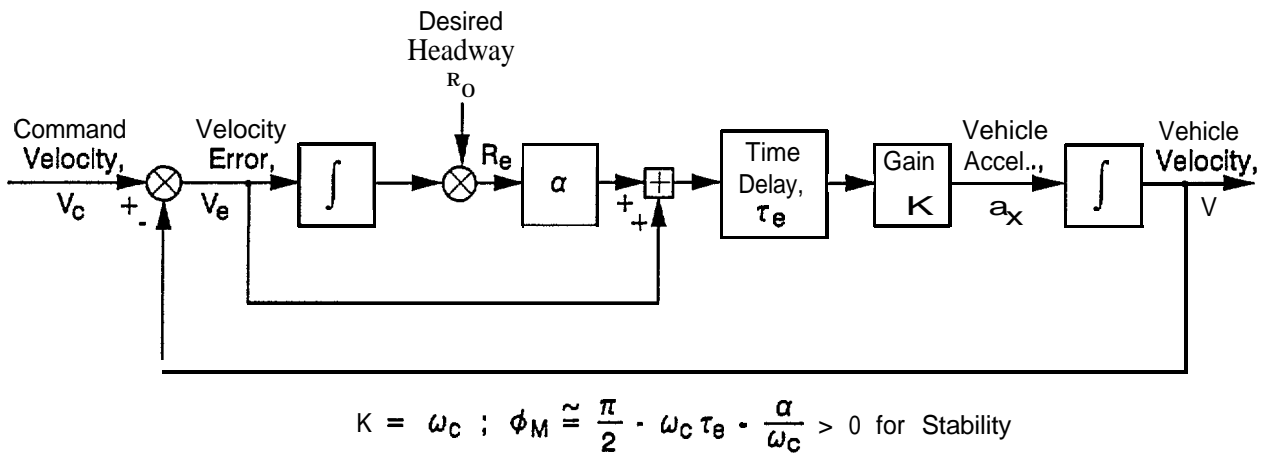

Figure 2. Extended Crossover Vehicle Following Model



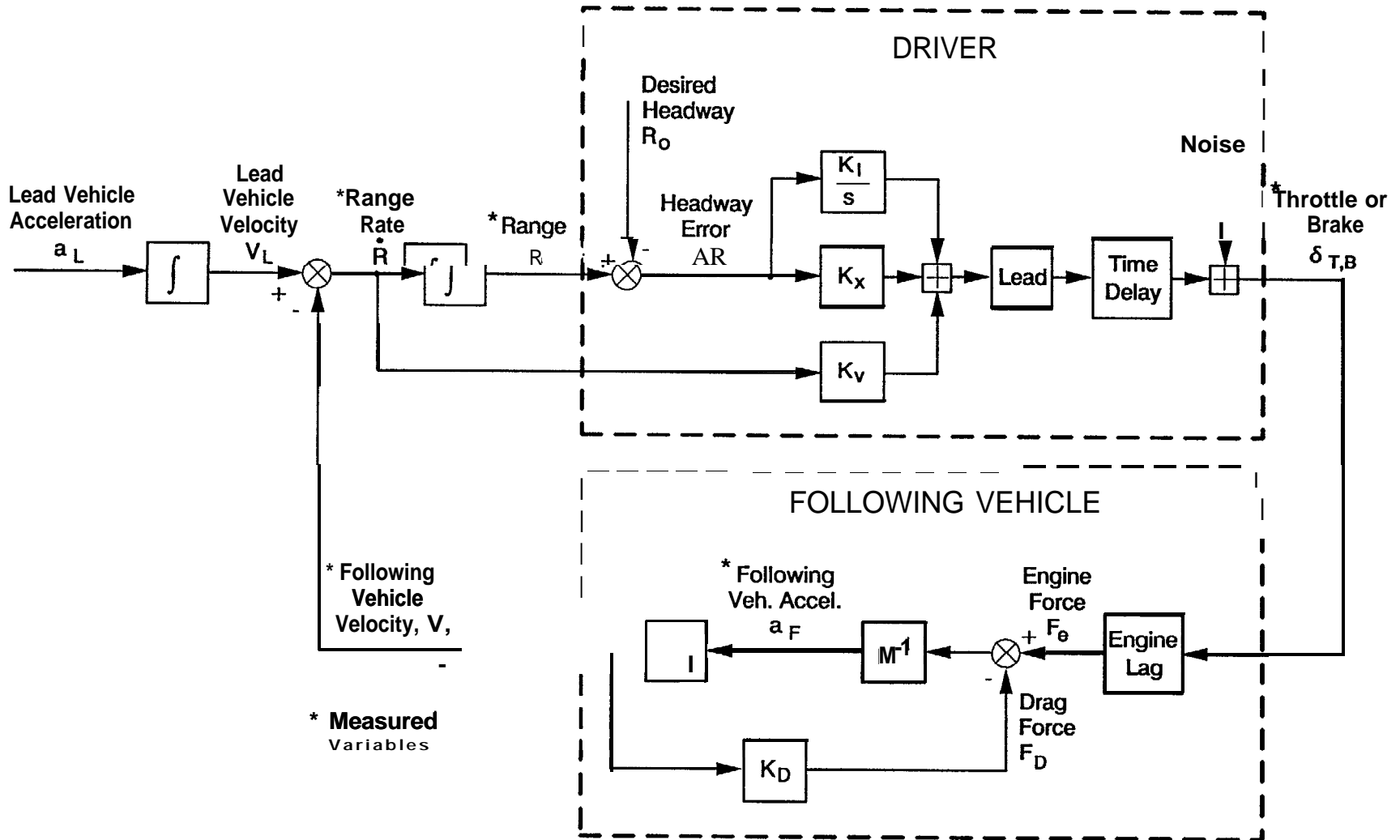

Figure 3. Detailed Car Following Model with Driver and Vehicle Dynamics

by frequency if any emphasis is desired). The transfer function model parameter set can give a better fit to FFT data over a wide frequency regime than the crossover models. However, this also results in a more complicated, multi-degree of freedom data set that is harder to characterize in terms of measures of typical behavior and variation across subjects.

## **D. TEST TRACK EXPERIMENT**

### **1. Methods and Procedures**

Participants – Twelve Ford employees (seven men and five women) took part in the study. The subjects were not members of the research team, but the human use research protocol for this study required them to be company employees. They were divided into two age groups, younger drivers (seven participants, mean age = 33 years) and mature drivers (five participants, mean age = 50 years).

Test Vehicles and Equipment – Two test vehicles with automatic transmissions were utilized in the study; the lead vehicle was a midrange four door sedan and the follow vehicle was a midrange sport coupe. The follow vehicle was instrument with a radar sensor mounted on the center of the front bumper to measure the relative velocity and distance of the lead vehicle with respect to the follow vehicle. Throttle angle (degrees), brake pressure (psi), and velocity (mph) of the follow vehicle were also recorded. Custom-written data acquisition software was used to collect and record data at a frequency of 20 Hz on an IBM PC-compatible computer located in the trunk of the follow vehicle. During testing, an IBM Thinkpad was used to view the data as it was collected. Interference from other vehicles on the test track as well as lap completion times and the time at which climate control tasks were performed (as explained in the procedure section) were recorded and time-synched with the data file.

Test Track Speed Profiles – The low speed test track at the Ford Dearborn Proving Grounds, shown in Figure 4, was used in the study. The track is 4.3 kilometers long and has six curves varying in radii from 606 to 241 meters.

Procedure – Participants were greeted by the experimenter at their workplace and driven to the test track in the follow vehicle. They were first given a brief overview of the study and then filled out a consent form indicating their willingness to participate in the study and a biographical form which provided the experimenter with information regarding personal characteristics (e.g., date of birth, occupation, etc.) and driving habits (e.g., vehicle driven, annual mileage, etc.). Example consent and biographical forms are shown in Appendices A and B, respectively.

The test participants were instructed to follow the lead vehicle as they normally would as if they were driving in traffic. (See Appendix C for the complete instructions.) So that participants would not alter their car following behavior, they were told that the objective of the study was to evaluate the usability of a

# FORD DEARBORN TEST TRACK

TR-2496-1

6

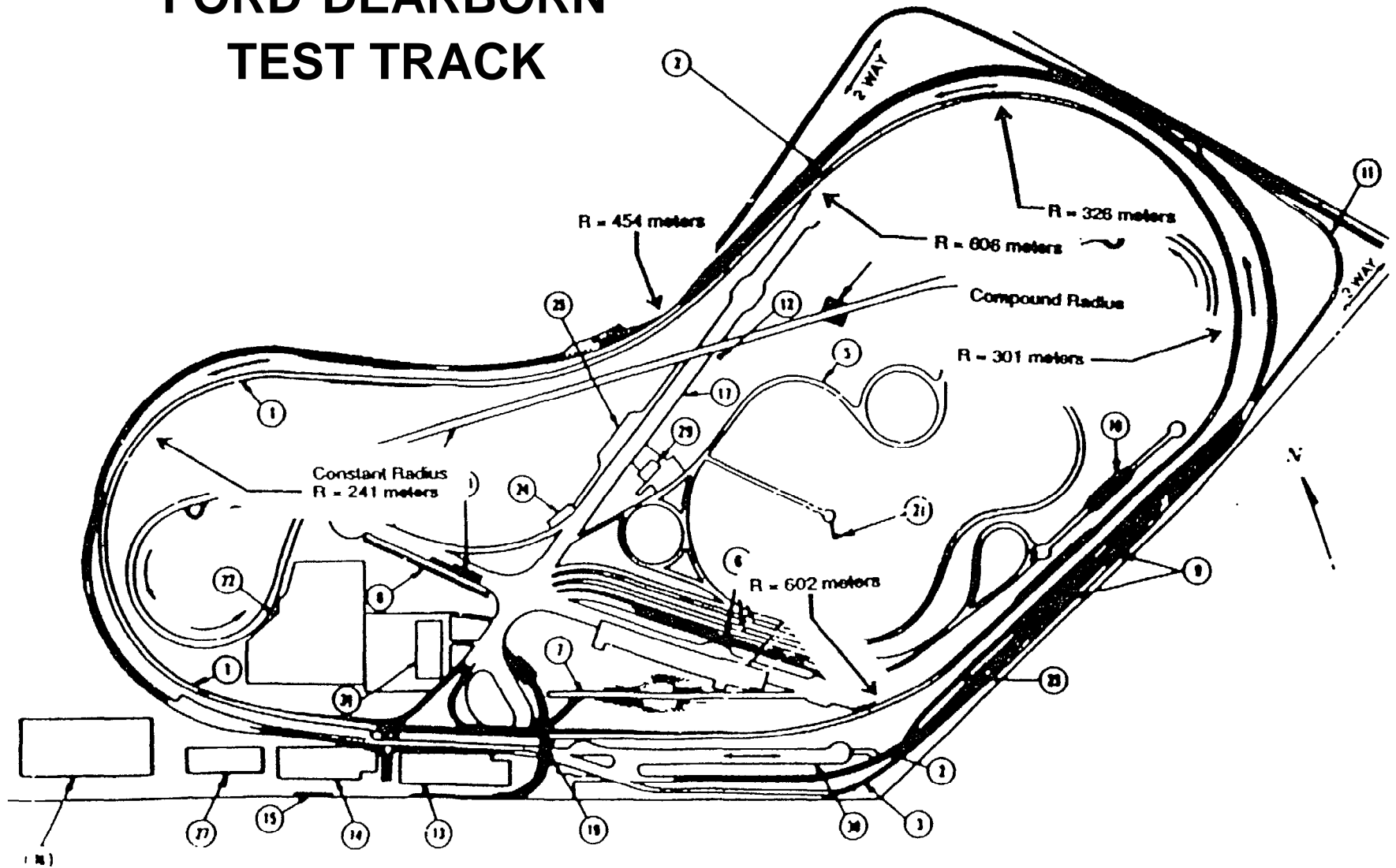

Low Speed Track = 2.7 Miles Long

Figure 4. Low Speed Test Track at the Ford Dearborn Proving Grounds

# EXAMPLE LEAD VEHICLE SPEED PROFILE

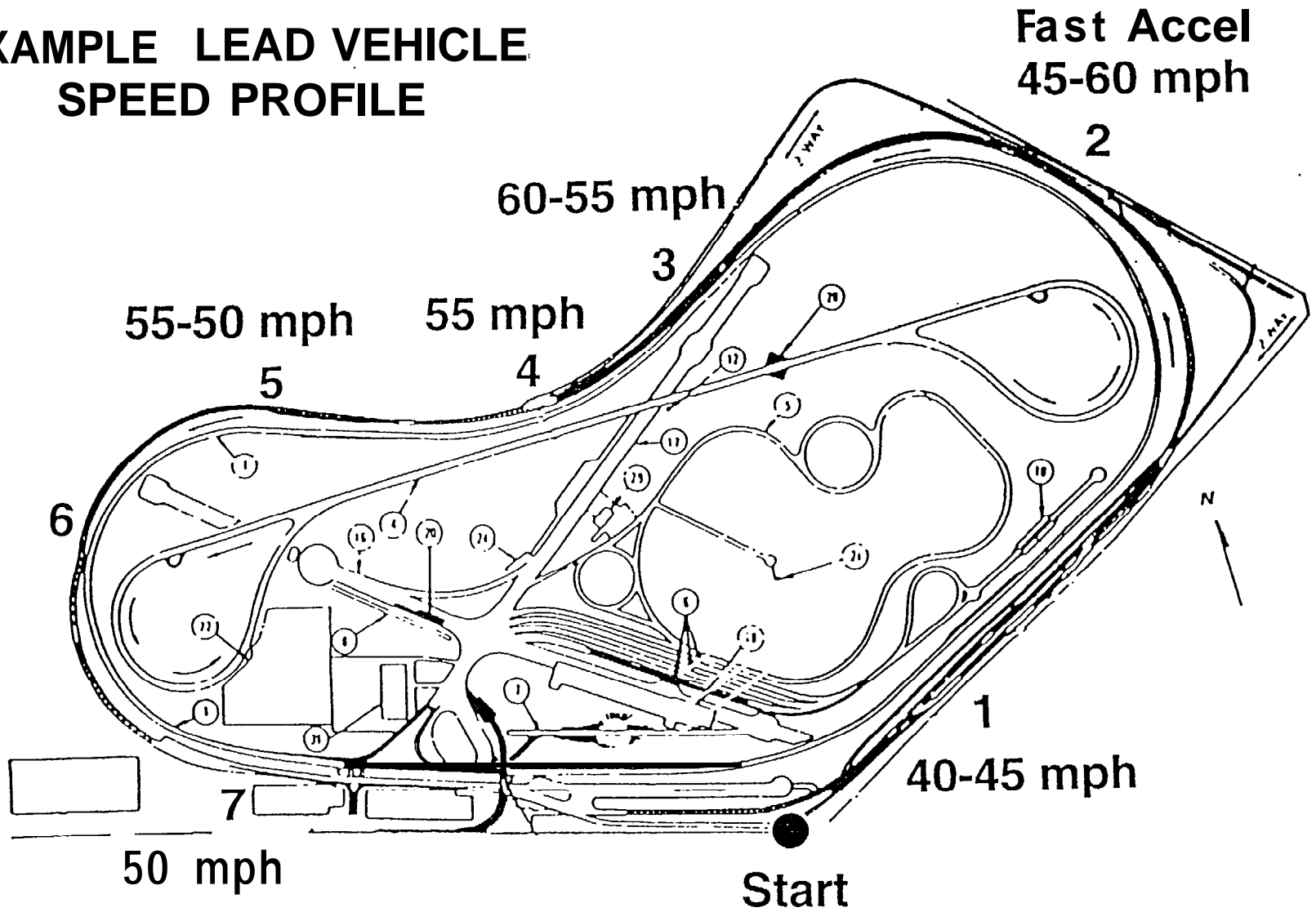

7

Figure 5. Lead Vehicle Speed Profiles for Test Track Experiment

Each participant drove six laps around the test track. On the final three laps, each participant performed a total of nine tasks using the climate control system as instructed by the experimenter. Examples of some of the tasks included increasing the temperature three degrees, checking the outside temperature, and decreasing the fan setting to the minimum output. Upon completion of the final lap, participants filled out a NASA TLX workload questionnaire (Hart and Staveland, 1988) rating the workload of the overall task on six dimensions. At the end of the session, participants were driven back to their workplace. Each test session lasted approximately one hour.

## 2. Results

Figure 6 shows a time series for a good data set. This time series was analyzed with FFT procedures which resulted in the transfer function data shown in Figure 7. The transfer function estimates represent frequency points that reached a coherence value of .65 or greater in the analysis procedure. The transfer function estimates span the crossover frequency region (.34 rad/sec). The model fit gives reasonable representation of the FFT data, and is consistent with the simple crossover model interpretation.

Crossover model data is summarized for eight different subjects in Table 1. Note that the average crossover frequency is .26 rad/sec while the equivalent time delay, as derived from the crossover frequency and phase margin, is 3.09 sec. This behavior is somewhat more conservative than previously reported. The phase margins indicate loop closures that range from critically damped to slightly under damped. The conservative behavior represented here is probably related to the extra task subjects were asked to perform using the entertainment/environmental controls.

As might be expected there is some tradeoff between driver dynamic behavior and performance. Figure 8 illustrates that driver headway tends to increase with time delay and decrease with crossover frequency. Multiple regression analysis was performed with headway ( $T_H$ ) as the dependent variable and crossover frequency ( $\omega_c$ ), phase margin ( $\phi_M$ ) and effective time delay ( $\tau_e$ ) as independent variables. The results are summarized in Table 2, which shows that the slopes of crossover frequency and time delay are a significant function of headway time, while phase margin is not dependent on headway time. These results indicate that driver dynamic behavior is generally related to headway time, with shorter headways leading to more aggressive driver control.

Extended crossover model fits were also obtained for many of the data runs as indicated in Table 1. In these extended crossover model fits, the driver time delay is lower than for the simple crossover model fits because the low frequency range trim parameter  $a$  accounts for some of the phase lag. Note that the data indicate trim frequencies (bandwidth) on the order of .02 rad/sec, or a time constant of on the order of 50 seconds! This indicates that the driver dynamics in maintaining a constant headway range is a very slow process, and is probably limited by the driver's ability to perceive changes in range.

## 3. Dynamic Analysis

Exemplary time data was selected for parameter fitting procedures using the detailed car following model shown in Figure 3. The first step was to fit the following vehicle transfer function. FFT data for the transfer function between throttle input and speed response were obtained, and good high coherence measurements were obtained over a wide frequency regime (i.e. .03-3.0 rad/sec). Then the transfer function data were submitted to parameter fitting procedures as described in Appendix D. This analysis identified engine lag dynamics in the region of 3.7 rad/sec and a drag pole, due to aerodynamic drag, down in the region of .026 rad/sec. The data in Figure 9 show that the parameter fit is quite consistent with the FFT

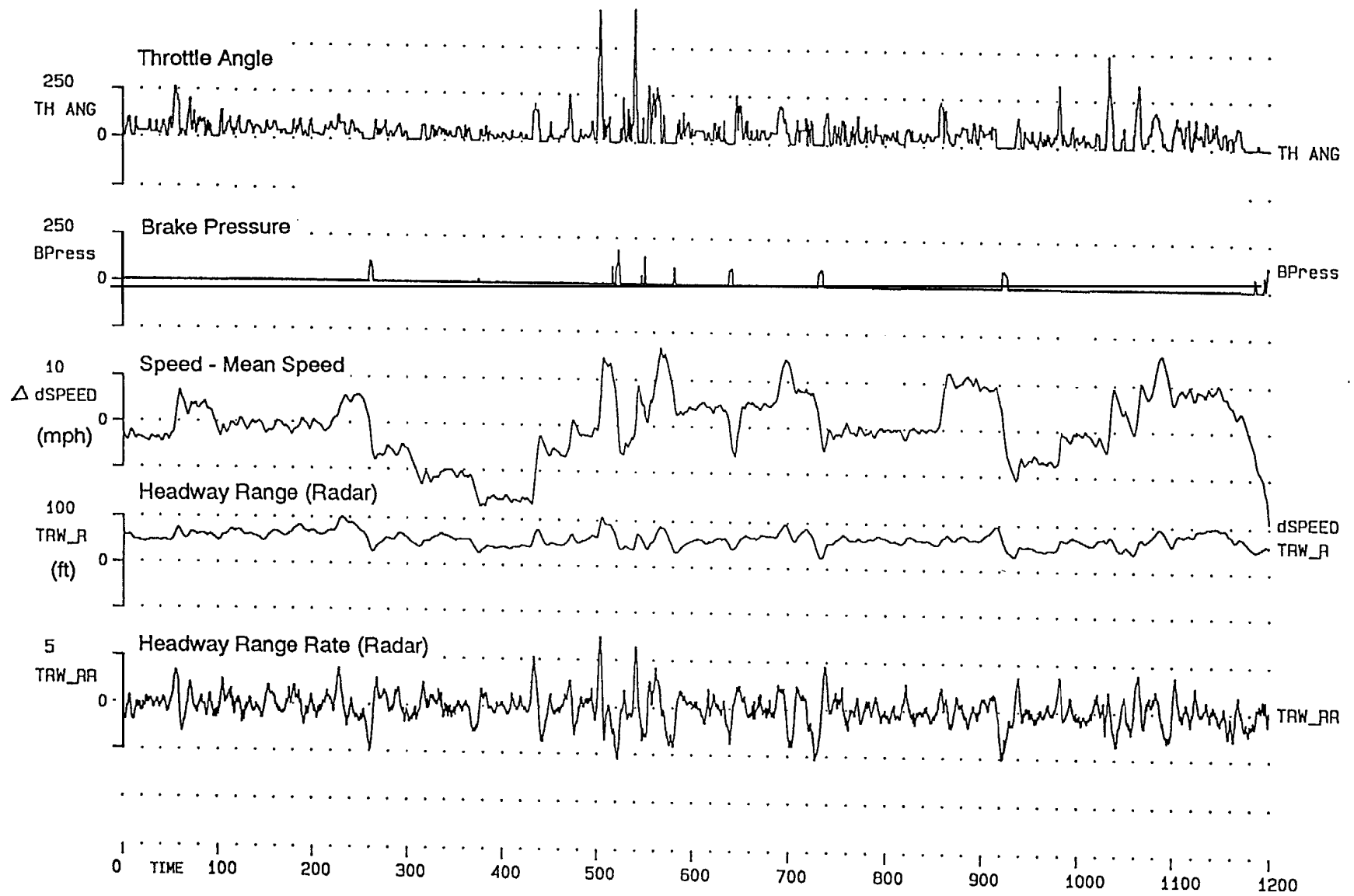
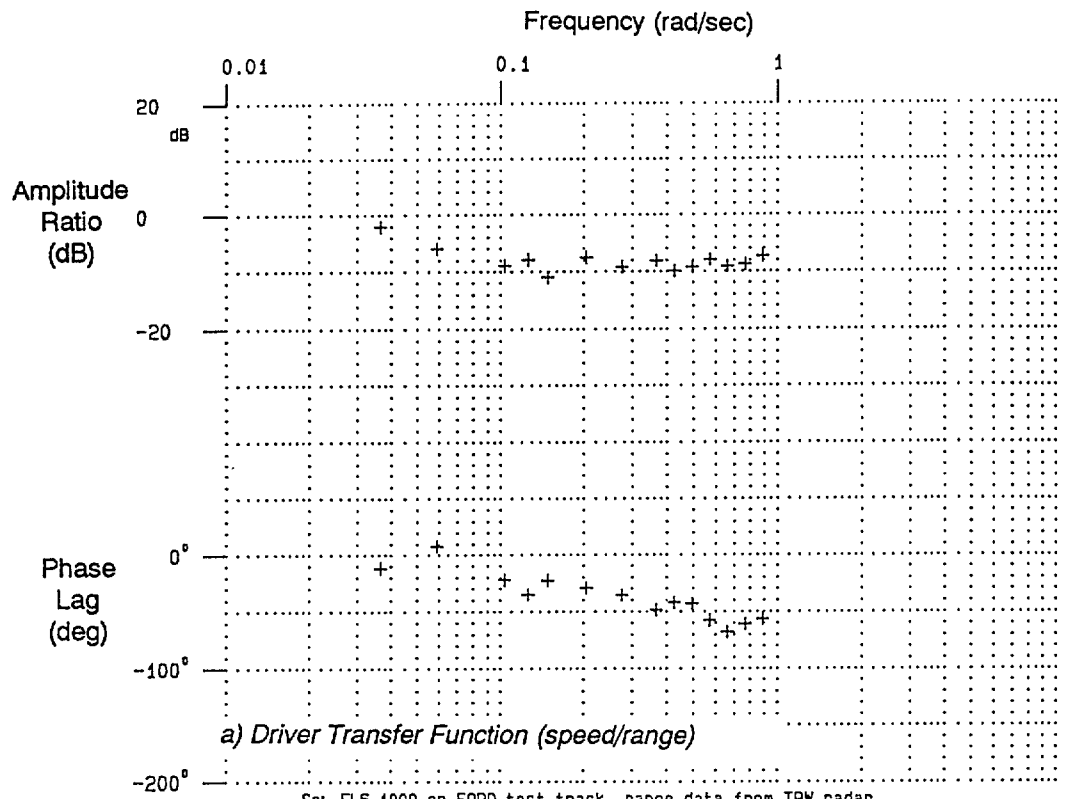

Figure 6. Data Time Histories for a Typical Test Track Run



Ss: FL6\_1000 on FORD test track, range data from TRW radar  
 ++ T.F. Vfps/ TRWR rho2 > .65 35,22400 1,50 1.15,4 01-27-96 12:26:23  
 X INP TRWR rms= 14.1  
 ++ OUT Vfps rms= 10.5 67

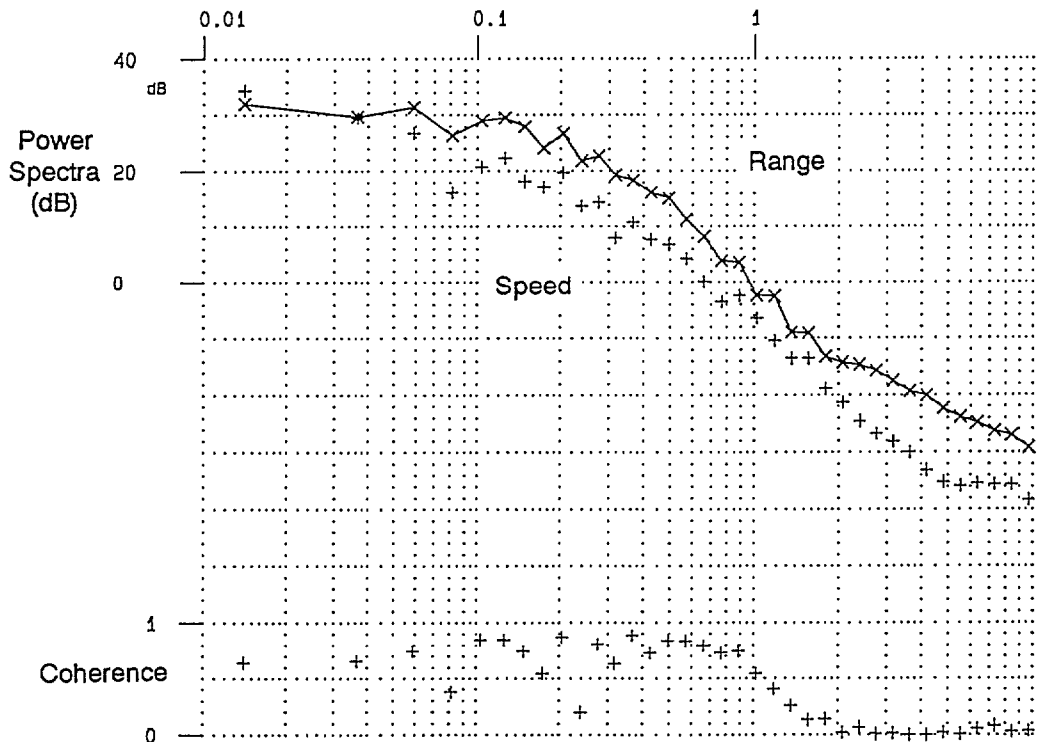
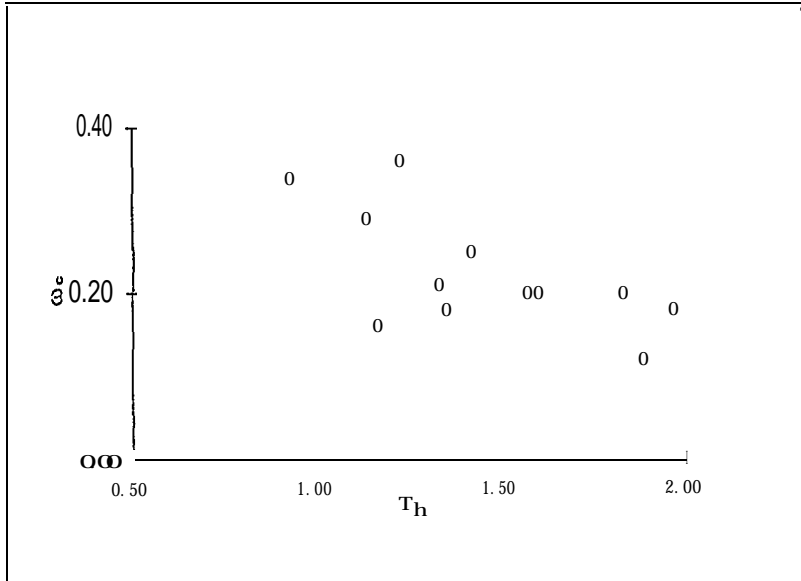

Figure 7. FFT Analysis of Figure 6 Time Data

TABLE 1. HEADWAY AND CROSSOVER MODEL FOR FORD TEST TRACK EXPERIMENT

| Subject No. | Age (yrs) | HEADWAY    |             |             | SIMPLE CROSSOVER MODEL |                |                |          | EXTENDED CROSSOVER MODEL <sup>1</sup> |         |
|-------------|-----------|------------|-------------|-------------|------------------------|----------------|----------------|----------|---------------------------------------|---------|
|             |           | $R_o$ (ft) | $U_o$ (mph) | $T_h$ (sec) | $\omega_c$             | $\phi_m$ (deg) | $\phi_m$ (rad) | $\tau_e$ | $\alpha$                              | $\tau$  |
| OA          | 34        | 76.80      | 36.80       | 1.42        | 0.25                   | 50.00          | 0.07           | 2.79     | 0.00604                               | 1.82491 |
| OB          | 34        | 71.50      | 41.60       | 1.17        | 0.16                   | 60.00          | 1.05           | 3.27     |                                       |         |
| 2           | 26        | 100.20     | 40.70       | 1.67        | 0.20                   | 50.00          | 0.87           | 3.49     | 0.00594                               | 1.76988 |
| 3           | 32        | 70.50      | 36.03       | 1.33        | 0.21                   | 37.00          | 0.65           | 4.41     | 0.02459                               | 2.6797  |
| 4           | 37        | 72.20      | 39.90       | 1.23        | 0.36                   | 42.00          | 0.73           | 2.33     | 0.03268                               | 1.55385 |
| 5           | 31        | 91.70      | 39.60       | 1.58        | 0.20                   | 60.00          | 1.05           | 2.62     |                                       |         |
| 6           | 37        | 105.00     | 39.00       | 1.83        | 0.20                   | 25.00          | 0.44           | 5.67     | 0.12298                               | 1.91245 |
| 7           | 38        | 100.00     | 36.00       | 1.89        | 0.12                   | 60.00          | 1.05           | 4.36     | 0.02238                               | 2.10306 |
| 8           | 45        | 80.00      | 40.30       | 1.35        | 0.18                   | 50.00          | 0.87           | 3.88     | 0.00616                               | 1.7452  |
| 10          | 32        | 61.60      | 45.20       | 0.93        | 0.34                   | 53.00          | 0.92           | 1.90     | 0.00793                               | 1.40859 |
| II          | 45        | 68.00      | 40.60       | 1.14        | 0.29                   | 35.00          | 0.61           | 3.31     | 0.00896                               | 1.97035 |
| 12          | 50        | 117.50     | 40.60       | 1.97        | 0.18                   | 42.00          | 0.73           | 4.65     | 0.00662                               | 2.71962 |
| X           | 33.92     | 84.58      | 36.64       | 1.35        | 0.21                   | 43.38          | 0.76           | 3.28     | 0.02                                  | 1.5     |
| $\sigma_x$  | 6.89      | 17.68      | 2.58        | 0.33        | 0.07                   | 11.07          | 0.19           | 1.09     | 0.04                                  | 0.4     |





a) Crossover Frequency

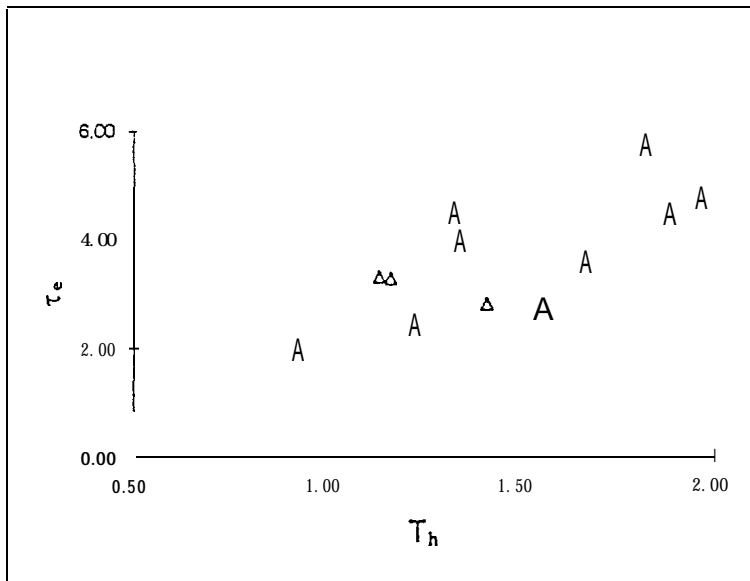

b) Time Delay

Figure 8. Driver Measured Crossover Model Parameters from Ford Test Track Experiment as a Function of Headway Time

TABLE 2. FORD TEST TRACK EXPERIMENT: MULTIPLE REGRESSION ANALYSIS OF CROSSOVER PARAMETER DEPENDENCY ON HEADWAY TIME

| <b>Using 2 independent variables:</b> |                     | $\tau_e$              | $\phi_m$      |                |                       |  |
|---------------------------------------|---------------------|-----------------------|---------------|----------------|-----------------------|--|
| SUMMARY OUTPUT                        |                     |                       |               |                |                       |  |
| <i>Regression Statistics</i>          |                     |                       |               |                |                       |  |
| Multiple R                            |                     | 0.767926967           |               |                |                       |  |
| R Square                              |                     | 0.589711826           |               |                |                       |  |
| Adjusted R Square                     |                     | 0.498536676           |               |                |                       |  |
| Standard Error                        |                     | 0.233366578           |               |                |                       |  |
| Observations                          |                     | 12                    |               |                |                       |  |
| ANOVA                                 |                     |                       |               |                |                       |  |
|                                       | <i>df</i>           | <i>ss</i>             | <i>MS</i>     | <i>F</i>       | <i>Significance F</i> |  |
| Regression                            | 2                   | 0.704483236           | 0.352241618   | 6.467900824    | 0.018150997           |  |
| Residual                              | 9                   | 0.490 139637          | 0.05445996    |                |                       |  |
| Total                                 | 11                  | 1.194622873           |               |                |                       |  |
|                                       | <i>Coefficients</i> | <i>Standard Error</i> | <i>f Stat</i> | <i>P-value</i> | <i>Lower 95%</i>      |  |
| Intercept                             | 0.006932472         | 0.542671611           | 0.012774709   | 0.990086234    | -1.220676937          |  |
| X Variable 1                          | 0.26890358          | 0.075450963           | 3.563951607   | 0.006081539    | 0.098221514           |  |
| X Variable 2                          | 0.604 192997        | 0.424963314           | 1.421753307   | 0.188812102    | -0.357141541          |  |

| <b>Using 2 independent variables:</b> |                     | $\phi_m$              | $\omega_c$    |                |                       |  |
|---------------------------------------|---------------------|-----------------------|---------------|----------------|-----------------------|--|
| SUMMARY OUTPUT                        |                     |                       |               |                |                       |  |
| <i>Regression Statistics</i>          |                     |                       |               |                |                       |  |
| Multiple R                            |                     | 0.728848262           |               |                |                       |  |
| R Square                              |                     | 0.531219789           |               |                |                       |  |
| Adjusted R Square                     |                     | 0.427046408           |               |                |                       |  |
| Standard Error                        |                     | 0.249447292           |               |                |                       |  |
| Observations                          |                     | 12                    |               |                |                       |  |
| ANOVA                                 |                     |                       |               |                |                       |  |
|                                       | <i>df</i>           | <i>ss</i>             | <i>MS</i>     | <i>F</i>       | <i>Significance F</i> |  |
| Regression                            | 2                   | 0.6346073 1           | 0.317303655   | 5.099381313    | 0.033064482           |  |
| Residual                              | 9                   | 0.5600 15563          | 0.062223951   |                |                       |  |
| Total                                 | 11                  | 1.194622873           |               |                |                       |  |
|                                       | <i>Coefficients</i> | <i>Standard Error</i> | <i>t Stat</i> | <i>P-value</i> | <i>Lower 95%</i>      |  |
| Intercept                             | 2.67105006          | 0.470283656           | 5.679657428   | 0.000301998    | 1.607193708           |  |
| X Variable 1                          | -0.541602997        | 0.406100322           | -1.333667983  | 0.215078829    | -1.460266448          |  |
| X Variable 2                          | -3.424797955        | 1.083345827           | -3.1613155    | 0.011525806    | -5.875498345          |  |

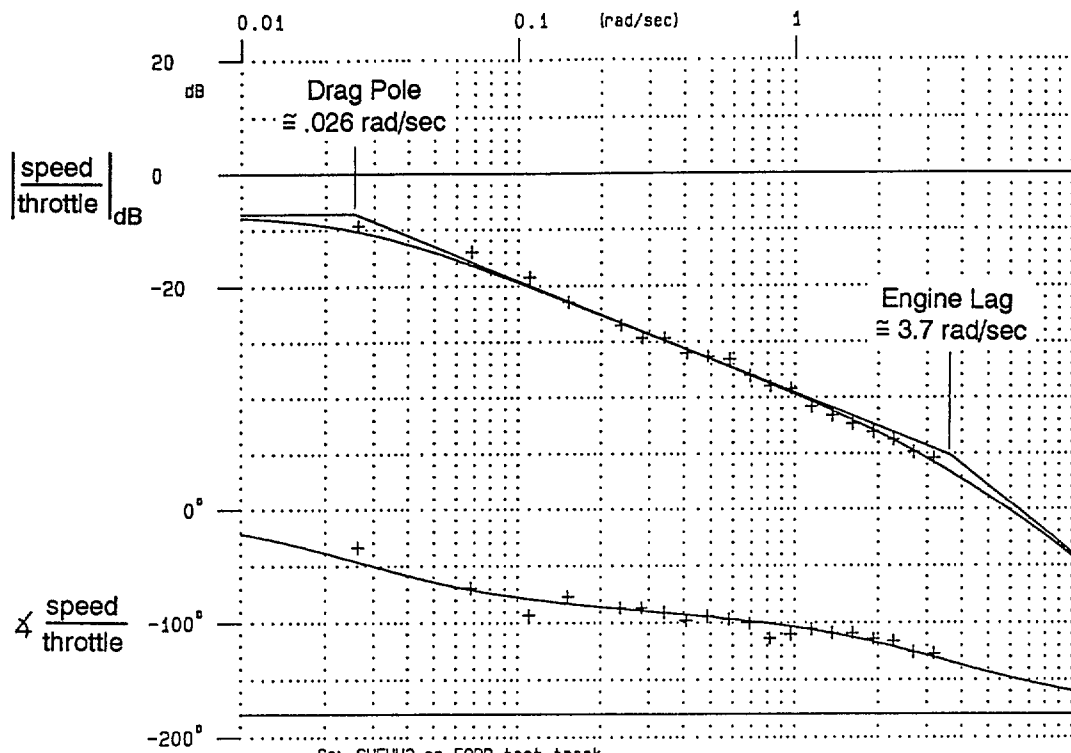

Ss: SHEHU2 on FORD test track  
 ++ T.F. SPD / TANG RHO2 > .80  
 X INP TANG RMS= 44.2  
 ++ OUT SPD RMS= 5.51 96

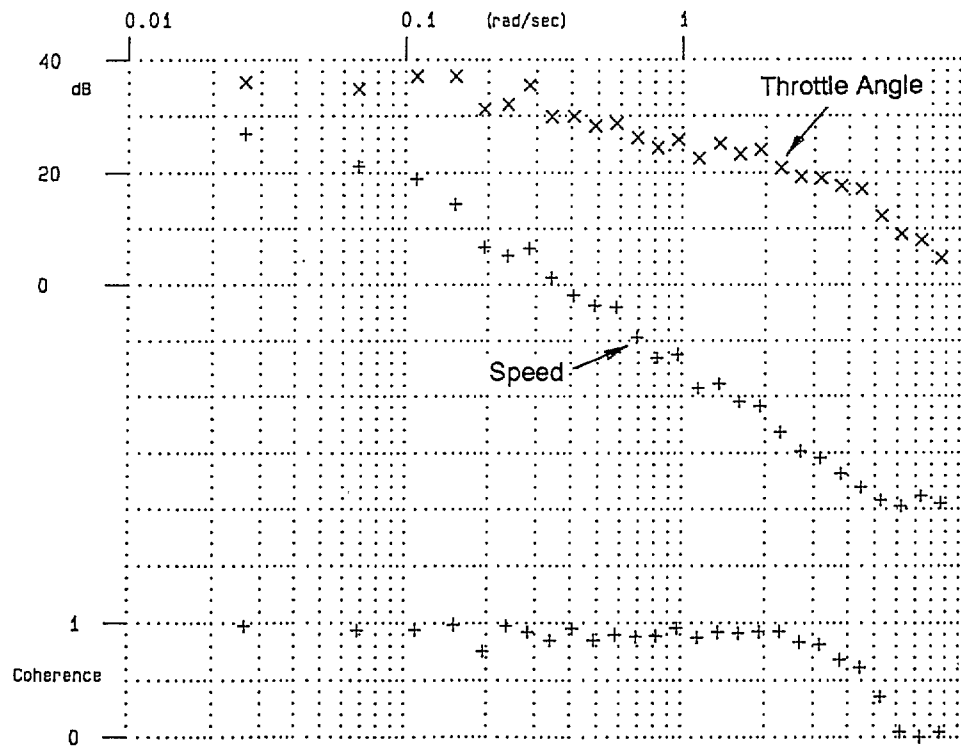

Figure 9. Vehicle Longitudinal Response Transfer Function Detailed Model Identification

transfer function data. This data also show that the vehicle dynamics can be approximated quite adequately over a wide frequency region by a pure integration (i.e. 20 dB/decade amplitude ratio slope and phase lag in the region of 90 degrees).

Given the vehicle identification above, the driver transfer function was then analyzed as indicated in Figure 10. Driver FFT transfer function data quality was restricted to a much narrower range than the vehicle response data. Even so, the transfer function model parameter fits obtained to the restricted FFT data set were reasonable as indicated in the Figure 10 comparison.

Finally, given the driver and vehicle detailed model parameter identification above, the model was analyzed to indicate the coupling dynamics between the lead and following vehicles. This analysis consisted of applying a speed change of about 5 mph to the lead vehicle, and observing the response of the following vehicle. Two runs for a given subject were analyzed as indicated in Figure 11. In the first run, the coupling between the lead and following vehicles is quite oscillatory, while in the second run the coupling is nicely damped. Note in Figure 11 that the driver model matches the change in the lead vehicle speed within a few seconds. This is consistent with the crossover frequency measures of about .21 rad/sec (a time constant of approximately 5 seconds) as indicated in Table 1. On the other hand the range accommodation in Figure 11 has a very long settling time which is on the order of tens of seconds. This behavior is consistent with the Table 1 a measurements of on the order of .02 rad/sec or a time constant of 50 seconds. This dynamic analysis thus suggests that the driver coupling dynamics in following a lead vehicle are relatively low frequency.

## E. OPENROADEXPERIMENT

### 1. Methods and Procedures

Researchers at the University of Michigan Transportation Research Institute (UMTRI) collected manual control data under open highway conditions. The manual control condition was one of three that was investigated; the other two conditions involved driving using conventional cruise control and driving using adaptive cruise control where vehicle speed and headway is controlled relative to a forward vehicle in the same lane.

Thirty-six drivers (18 men and 18 women equally divided into three age groups (20-30 years, 40-50 years, and 60-70 years), were recruited from a local driver and vehicle licensing office to serve as participants. The subjects drove a 1993 compact imported sedan, instrumented with an infrared headway sensor, around a 55 mile route in Southeast Michigan that took approximately 50-60 minutes to complete. The highway route and average traffic density conditions are summarized in Figure 12. The study was run during non-peak travel times, and due to the open road conditions was less controlled than the Ford test track study. While a variety of data were recorded, the following six measures were supplied for analysis herein: acceleration, engine throttle position, brake pedal depression and velocity of the instrumented test vehicle, and range and range rate to a lead vehicle.

### 2. Results

Figure 13 shows a typical time trace of one subject's data. Range dropouts are apparent in the data which limit FFT analysis. However, time windows were identified as indicated where reasonable FFT analyses could be obtained. Figure 14 shows a time expansion of data selected from Figure 13 for analysis. Data quantization can be noted here, which illustrates digital resolution in range, range rate and speed. The range drop outs plus quantization have limited the quality of subsequent FFT analysis of the open road data.

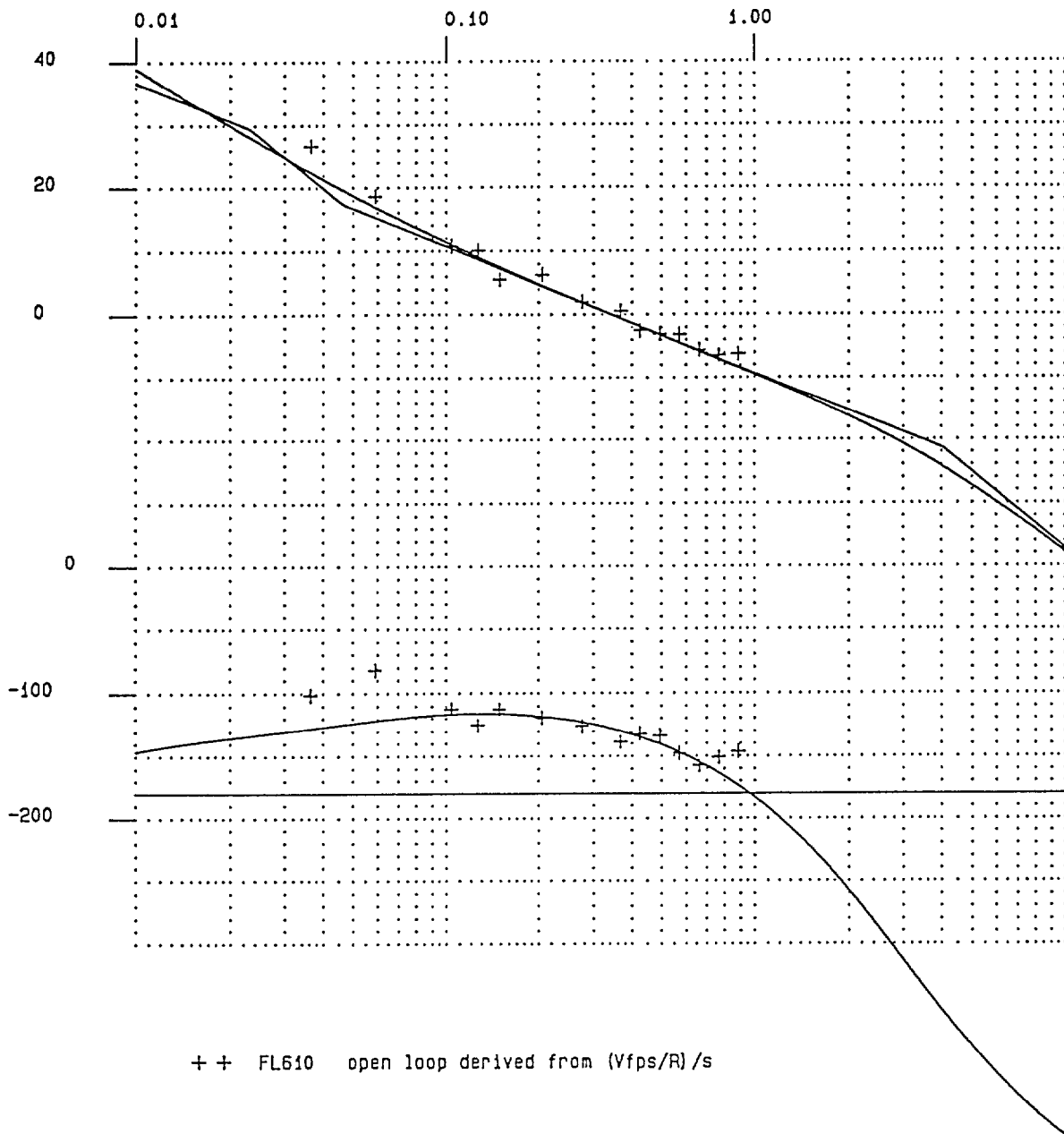

**MODEL FIT:**

$\tau = 1.4 \text{ sec}$   
 No Lead  
 $K_V = 38 \text{ thr. units/mph}$   
 $K_X = 2.1 \text{ thr. units/ft}$   
 $K_I = .017 \text{ thr. unit-sec/ft}$

**SUMMARY DATA:**

$R_O = 61.6 \text{ ft}$   
 $U_O = 45.2 \text{ mph}$   
 $T_H = .93 \text{ sec}$   
 $\omega_C = .34 \text{ rad/sec}$   
 $\phi_M = 53^\circ$

Figure 10. Driver/Vehicle Detailed Car Following Model Identification

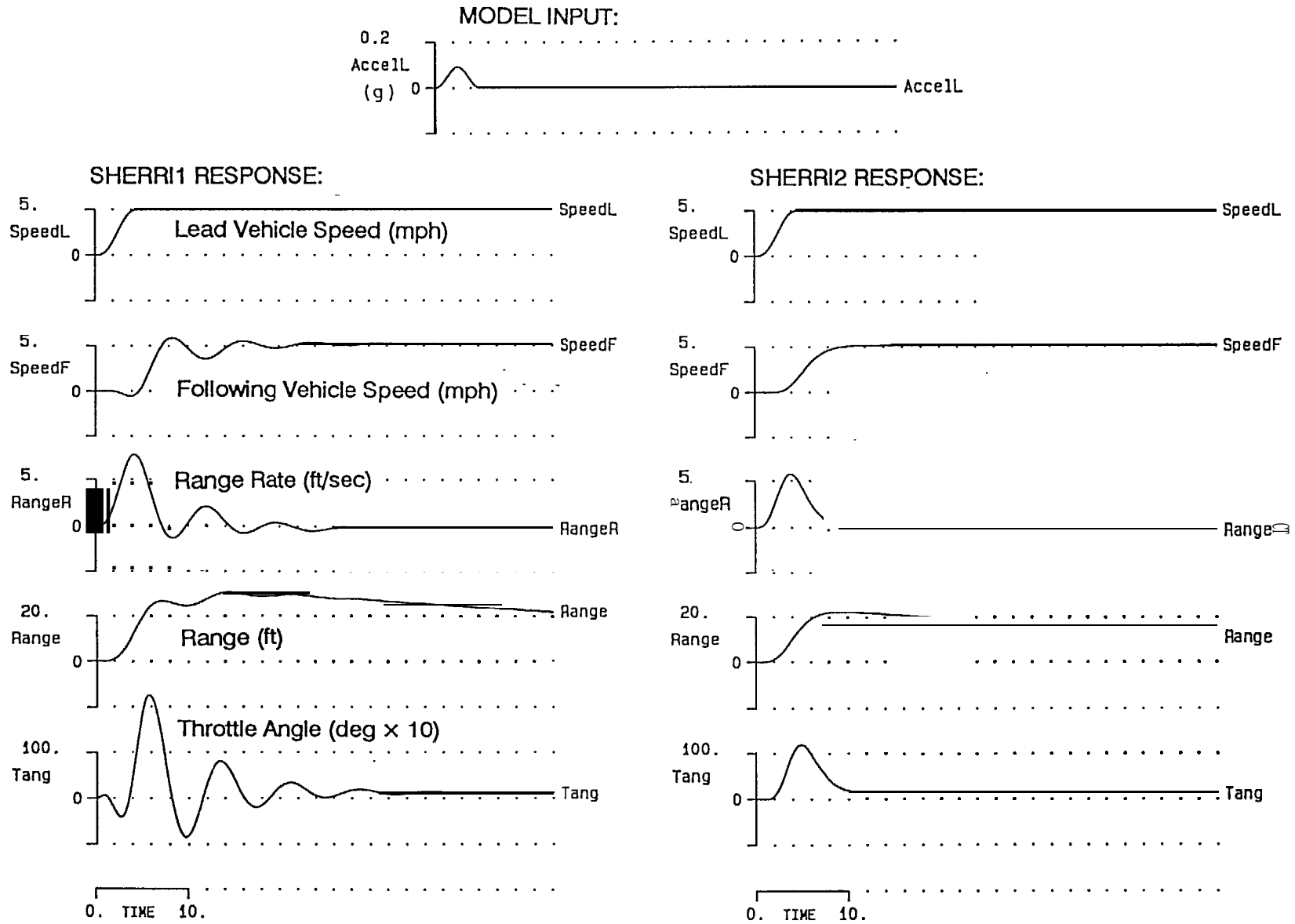
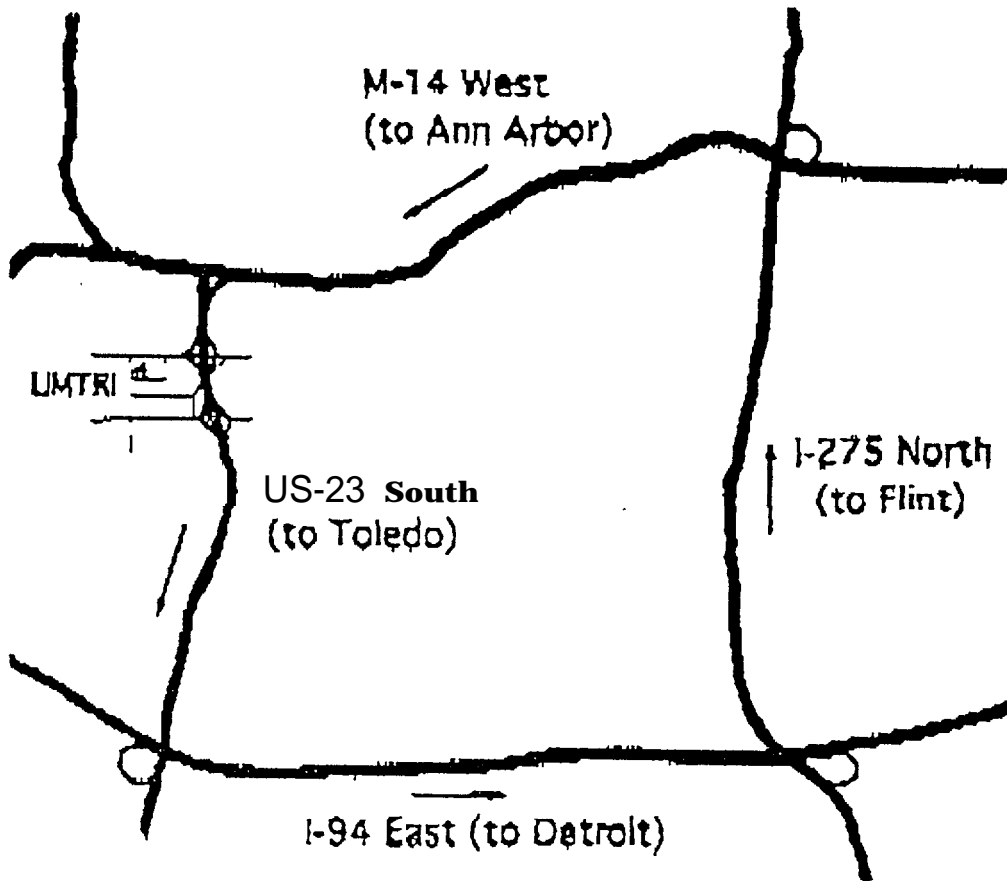

Figure 11. Driver/Vehicle Detailed Model Dynamic Response Analysis



| <u>Segment</u> | <u>Average Volume</u> | <u>Lanes</u> |
|----------------|-----------------------|--------------|
| US23 (South)   | 44,000 - 56,000       | 2            |
| I-94 (East)    | 60,000 - 91,000       | 2-3          |
| I-275 (North)  | 45,000 - 112,000      | 3-4          |
| M142(West)     | 3 43,000 v 70,000     |              |

Source: Michigan Department of Transportation (1993)

Figure 12. Driving Route Characteristics for UMTRI Open Road Experiment

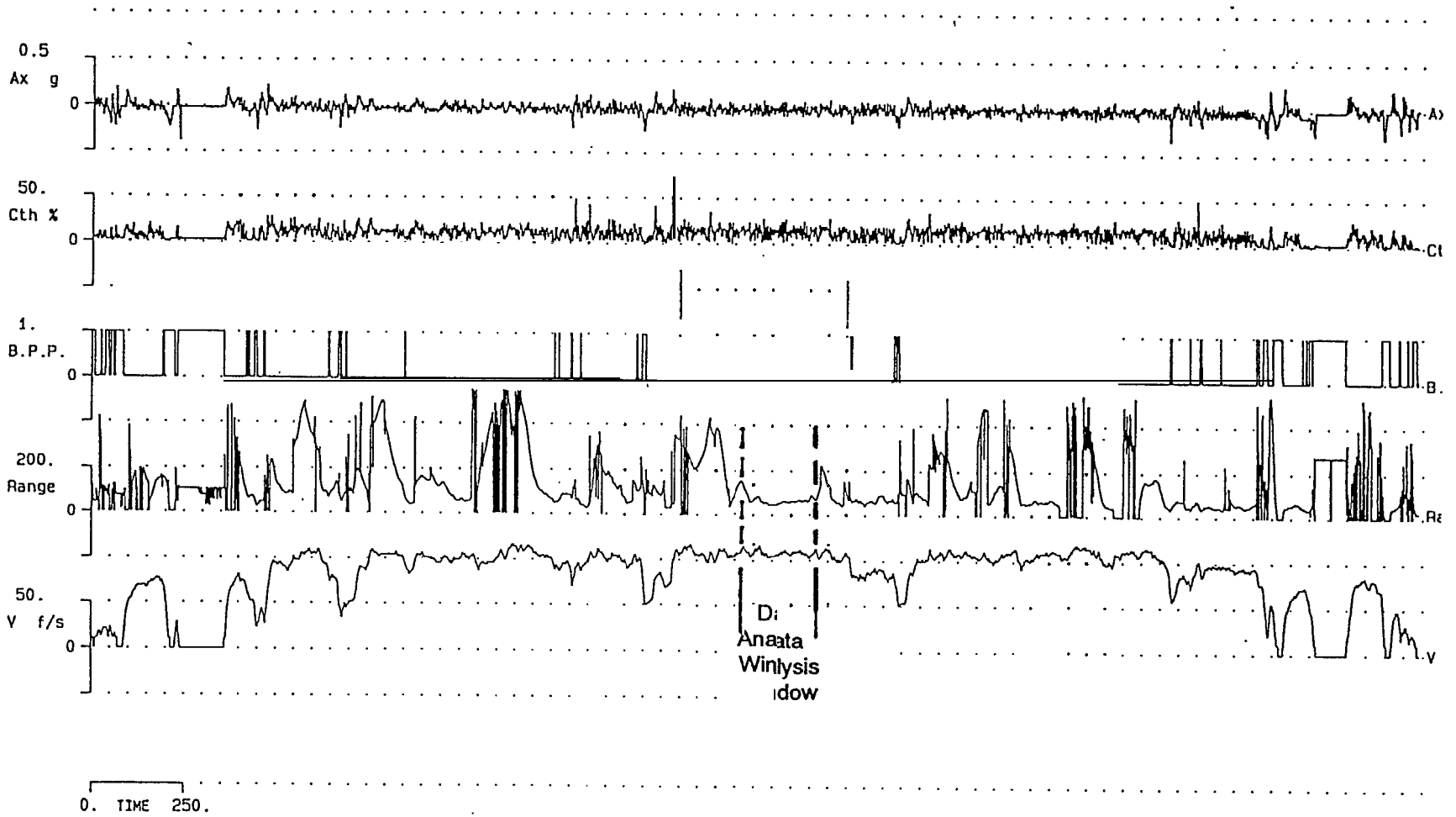

Figure 13. Raw Time Histories from UMTRI Data Base



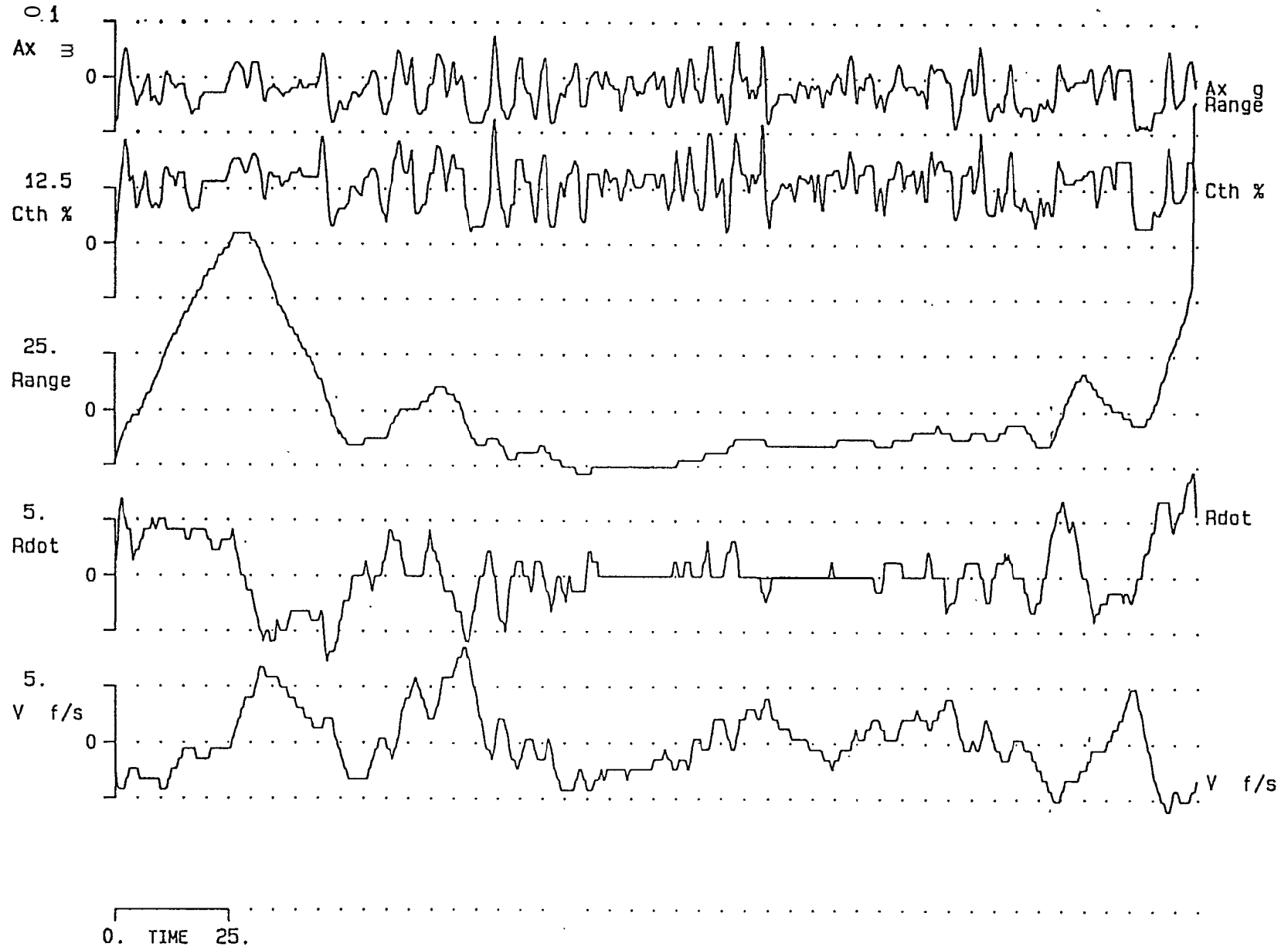

Figure 14. UMTRI Data Segment Used in Spectral Analysis

Figure 15 shows an example spectral analysis of the Figure 14 open road car following data. The top plot shows the amplitude and phase data for the driver's response transfer function and the bottom plot shows the range and velocity power spectra and the coherence of the analysis. The coherence shows that we are getting reasonable identification of the driver response out to a frequency of just slightly above 1 radian/sec which is consistent with the test track data. The top transfer function plot shows the driver in this case was acting as a gain below 0.3 rad/sec, with some lead or anticipation above this frequency.

Figure 16 shows an example of open loop and closed loop transfer functions. The top open loop transfer function indicates a crossover frequency of about 0.23 rad/sec and a corresponding phase margin of about 60 degrees. These characteristics are within the range of the Ford test track data summarized in Table 1. The closed loop transfer function indicates that the driver has established a somewhat under damped coupling with the lead vehicle.

Table 3 shows tabulated data and crossplots of crossover frequency ( $\omega_c$ ) and time delay ( $\tau_e$ ) versus headway time  $T_h$ . The crossover frequencies and phase margins were read from the transfer function plots, then time delay was computed as described previously herein. The crossover frequencies, time delays and headway times are roughly within the range of the Ford test track data. However, the Figure 17 crossplots do not show the consistent changes in crossover frequency and time delay with respect to headway time that we saw in the test track data.

Table 4 summarizes multiple regression analysis of the open road driver behavior data. The dependent variable was headway time and the independent variables were either time delay and phase margin or phase margin and crossover frequency. The results do not show a significant relationship between the independent and dependent variables as did the Ford test track data. This is probably due to the influence of more uncontrolled variables operating in the public highway environment.

## F. DISCUSSION

We have successfully analyzed open road car following data collected by UMTRI and validated the general findings of the Ford test track experiment. The overall objective of the manual headway control experiment was to measure the dynamic coupling drivers achieve with respect to a lead vehicle. We have a consistent measurement of this coupling under both test track and open highway driving conditions although the open highway data does not show the dependence between coupling characteristics and headway time that we found for the test track data. This result may be due to the influence of more uncontrolled variables operating out in the open highway environment which would not be surprising.

This study has identified driver headway control characteristics that are quite slow compared to other control processes such as steering for path following and maintaining lane position. The driver exhibits time constants and time delays on the order of several seconds to tens of seconds that limit the stable control bandwidth that can be achieved in maintaining headway. These continuous control time constants and time delays are probably due to processes associated with range and range rate perception, and should not be confused with discrete reaction times associated braking which are considerably shorter.

In general we would conclude that we have established solid dynamic characteristics for the manual car following task. This data should provide a solid basis for subsequent testing of the aggressiveness of automatic car following dynamics, and determining what levels are acceptable and/or appealing to drivers.

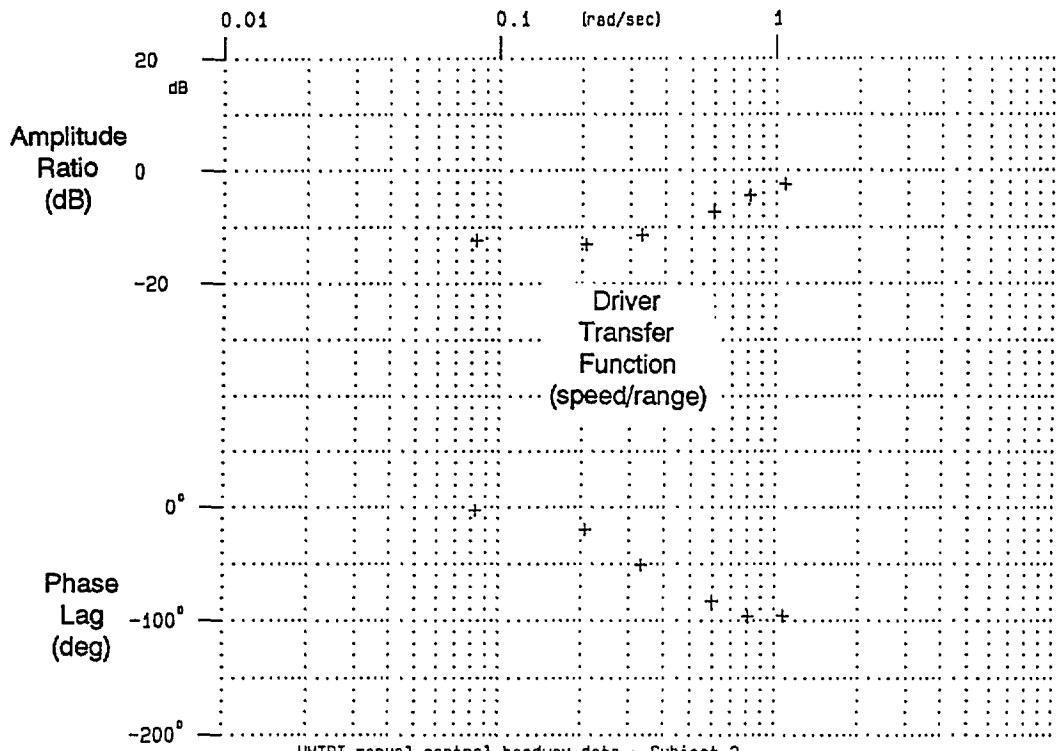

UMTRI manual control headway data - Subject 2

|    |      |         |        |      |       |     |      |       |          |          |
|----|------|---------|--------|------|-------|-----|------|-------|----------|----------|
| ++ | T.F. | Vel / R | rho2 > | .65  | 1793, | 760 | 1.20 | 1.3,3 | 08-11-95 | 15:11:08 |
| X  | INP  | R       | rms=   | 8.45 |       |     |      |       |          |          |
| ++ | OUT  | Vel     | rms=   | 2.50 | 76    |     |      |       |          |          |

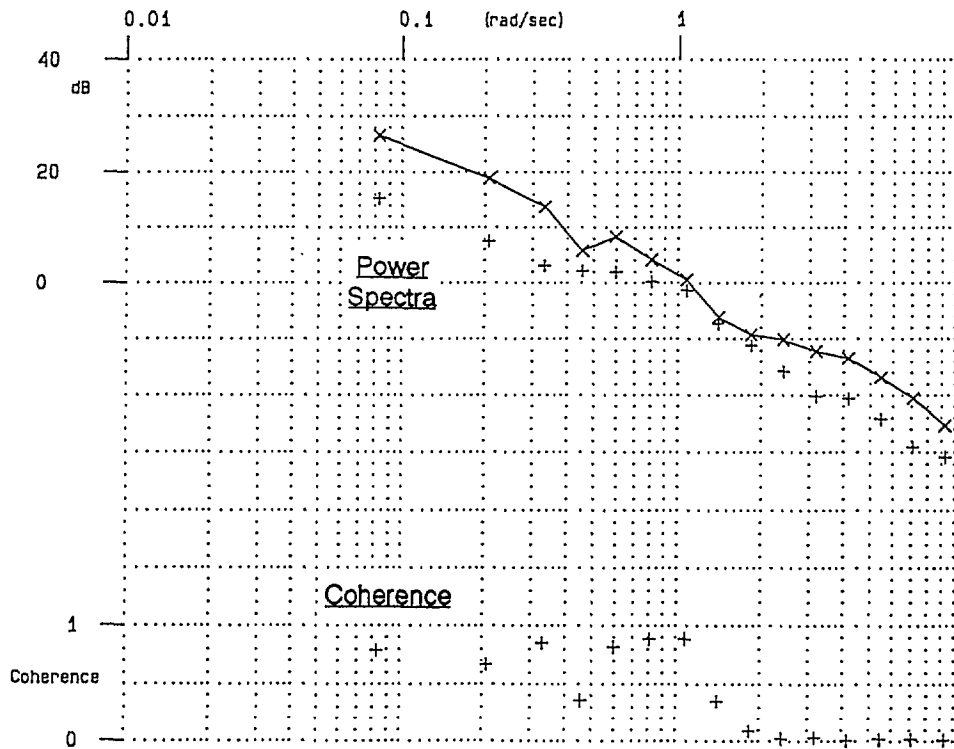

Figure 15. Example Spectral Analysis for UMTRI Data

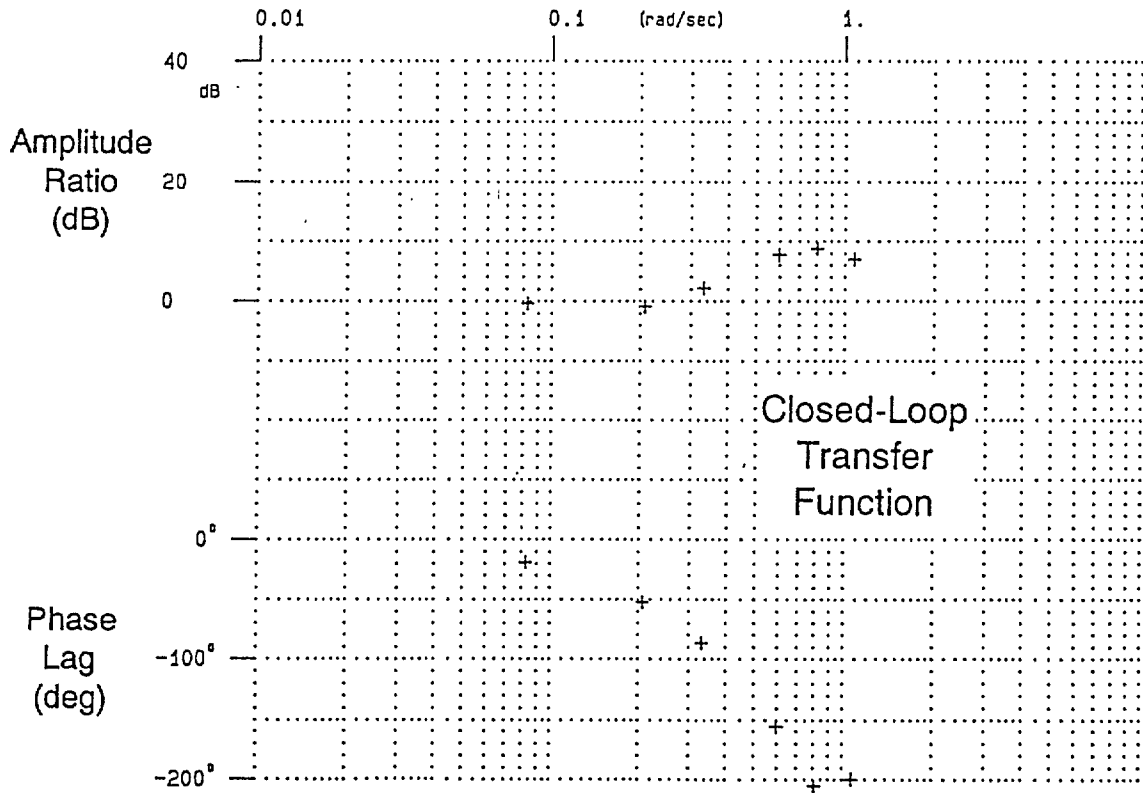
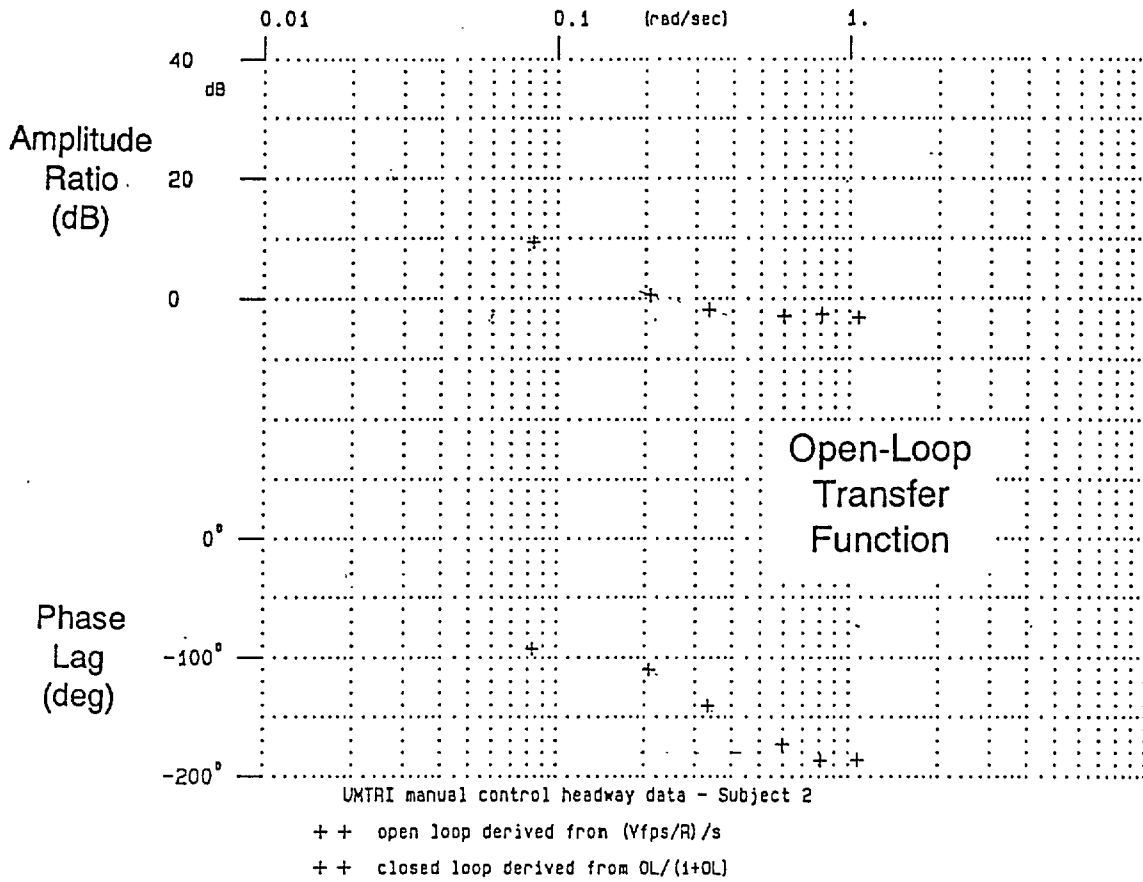

Figure 16. Open-Loop and Closed-Loop Driver/Vehicle Transfer Functions  
From UMTRI Data Base

TABLE 3. UMTRI OPEN HIGHWAY EXPERIMENT HEADWAY  
AND CROSSOVER FREQUENCY

| Subject No. | $R_o$ (ft) | $V_o$ (ft/sec) | $U_o$ (mph) | $T_h$ (sec) | $\omega_c$ | $\phi_m$ (deg) | $\phi_m$ (rad) | $\tau_e$ | Age (yrs) | Gender | Cruise Usage |
|-------------|------------|----------------|-------------|-------------|------------|----------------|----------------|----------|-----------|--------|--------------|
| 1           | 110.00     | 79.80          | 54.29       | 1.38        | 0.35       | 45.00          | 0.79           | 2.24     | 20-30     | F      | NU           |
| 2           | 62.10      | 108.00         | 73.47       | 0.58        | 0.24       | 60.00          | 1.05           | 2.18     | 20-30     | F      | NU           |
| 7           | 118.00     | 91.90          | 62.52       | 1.28        | 0.22       | 22.00          | 0.38           | 5.39     | 20-30     | M      | NU           |
| 14          | 185.10     | 97.20          | 66.12       | 1.90        | 0.24       | 30.00          | 0.52           | 4.36     | 40-50     | F      | NU           |
| 16          | 128.00     | 104.80         | 71.29       | 1.22        | 0.15       | 60.00          | 1.05           | 3.49     | 40-50     | F      | FU           |
| 18          | 72.90      | 89.60          | 60.95       | 0.81        | 0.12       | 45.00          | 0.79           | 6.55     | 40-50     | F      | FU           |
| 22          | 97.20      | 88.10          | 59.93       | 1.10        | 0.13       | 50.00          | 0.87           | 5.37     | 40-50     | M      | FU           |
| 27          | 101.20     | 78.80          | 53.61       | 1.28        | 0.29       | 30.00          | 0.52           | 3.61     | 60-70     | F      | NU           |
| 34          | 134.20     | 93.80          | 63.81       | 1.43        | 0.11       | 21.00          | 0.37           | 11.47    | 60-70     | M      | NU           |
| $\bar{X}$   | 112.08     | 92.44          | 62.89       | 1.22        | 0.21       | 40.33          | 0.70           | 4.96     |           |        |              |
| $\sigma_x$  | 36.21      | 9.95           | 6.77        | 0.38        | 0.08       | 15.14          | 0.26           | 2.84     |           |        |              |

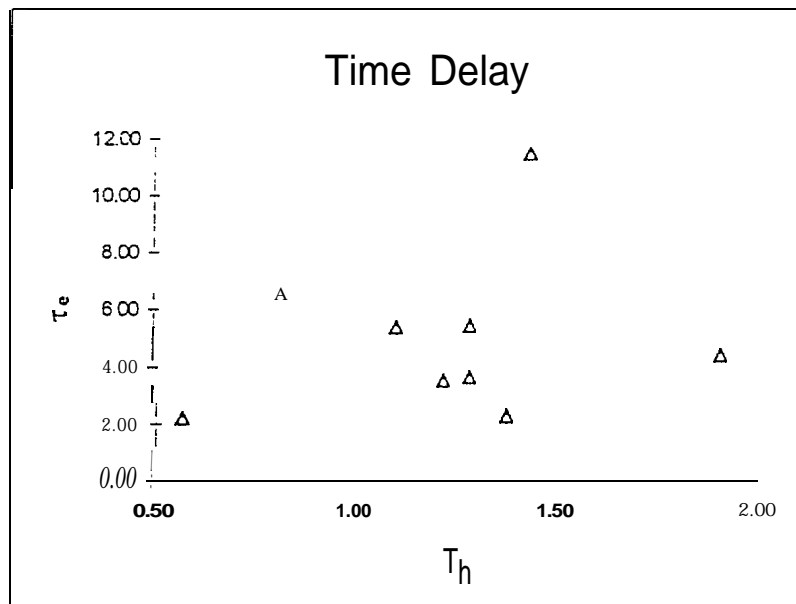
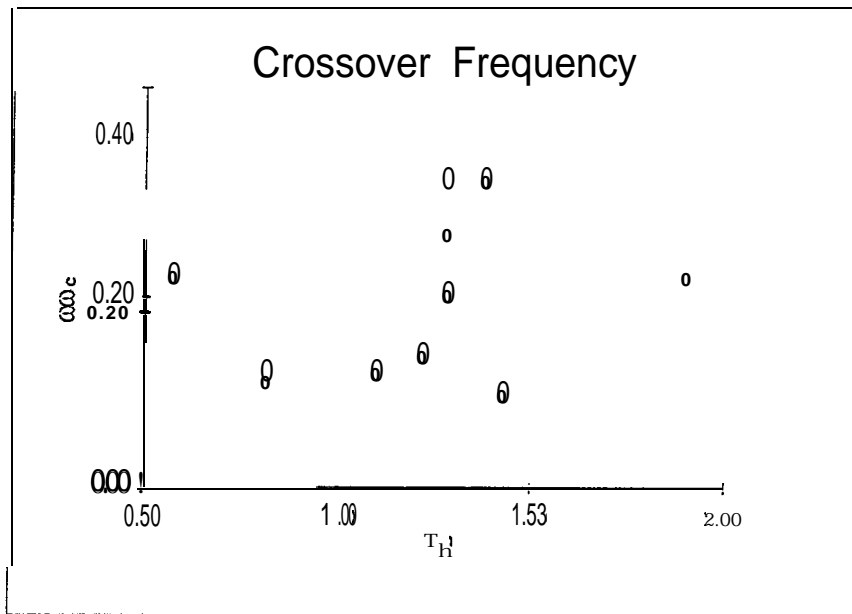

Figure 17. Driver Measured Crossover Model Parameters from UMTRI Open Highway Experiment as a Function of Headway Time

Table 4. UMTRI Open Highway Experiment: Multiple Regression Analysis of Crossover Parameter Dependency on Headway Time

| Using 2 independent variables: |                     | $\tau_e$              | $\phi_m$      |                |                  |
|--------------------------------|---------------------|-----------------------|---------------|----------------|------------------|
| <b>SUMMARY OUTPUT</b>          |                     |                       |               |                |                  |
| <i>Regression Statistics</i>   |                     |                       |               |                |                  |
| Multiple R                     |                     | 0.644597              |               |                |                  |
| R Square                       |                     | 0.4155053             |               |                |                  |
| Adjusted R Square              |                     | 0.2206737             |               |                |                  |
| Standard Error                 |                     | 0.3333636             |               |                |                  |
| Observations                   |                     | 9                     |               |                |                  |
| <b>ANOVA</b>                   |                     |                       |               |                |                  |
|                                | df                  | ss                    | MS            | F              | Significance F   |
| Regression                     | 2                   | 0.47400566            | 0.23700283    | 2.1326383      | 0.19968332       |
| Residual                       | 6                   | 0.6667877             | 0.11113128    |                |                  |
| Total                          | 8                   | 1.14079336            |               |                |                  |
|                                | <i>Coefficients</i> | <i>Standard Error</i> | <i>t Stat</i> | <i>P-value</i> | <i>Lower 95%</i> |
| Intercept                      | 2.1494536           | 0.57877016            | 3.71382935    | 0.0099245      | 0.73325301       |
| $\tau_e$                       | -0.0336166          | 0.05073305            | -0.6626 183   | 0.5321882      | -0.15775603      |
| $\phi_m$                       | -1.0810161          | 0.54588683            | -1.9802933    | 0.0949853      | -2.41675397      |
| Using 2 independent variables: |                     | $\phi_m$              | $\omega_c$    |                |                  |
| <b>SUMMARY OUTPUT</b>          |                     |                       |               |                |                  |
| <i>Regression Statistics</i>   |                     |                       |               |                |                  |
| Multiple R                     |                     | 0.6373383             |               |                |                  |
| R Square                       |                     | 0.4062001             |               |                |                  |
| Adjusted R Square              |                     | 0.2082669             |               |                |                  |
| Standard Error                 |                     | 0.3360067             |               |                |                  |
| Observations                   |                     | 9                     |               |                |                  |
| <b>ANOVA</b>                   |                     |                       |               |                |                  |
|                                | df                  | ss                    | MS            | F              | Significance F   |
| Regression                     | 2                   | 0.46339042            | 0.23169521    | 2.0522073      | 0.20937281       |
| Residual                       | 6                   | 0.67740294            | 0.11290049    |                |                  |
| Total                          | 8                   | 1.14079336            |               |                |                  |
|                                | <i>Coefficients</i> | <i>Standard Error</i> | <i>t Stat</i> | <i>P-value</i> | <i>Lower 95%</i> |
| Intercept                      | 1.6600178           | 0.45174399            | 3.67468707    | 0.0103961      | 0.55463927       |
| $\phi_m$                       | -0.8617172          | 0.44995687            | -1.9151106    | 0.1039686      | -1.9627228       |
| $\omega_c$                     | 0.8205456           | 1.41104793            | 0.58151507    | 0.5820655      | -2.6321668       |

The above results are somewhat more conservative, but not inconsistent with, past driver headway control research. This current data give us a reasonable range of driver car following dynamic behavior to provide a model for adjusting the dynamic behavior of an ICC system.

#### G. IMPLICATIONS FOR FURTHER RESEARCH

The results and findings thus far on this project suggest several hypotheses that can be tested in work with the next generation ICC. We currently have a good description of the dynamic coupling behavior of drivers in manually controlling headway. With an automatic headway control system two general questions arise. First, what automatic dynamic coupling is desired by drivers? Second, from a safety point of view during rapid overtaking conditions what haptic cue from the ICC is appropriate to obtain rapid driver crash avoidance response?

Regarding the ICC dynamic coupling, it might be that drivers like a bandwidth or crossover frequency that is similar to that achieved manually during headway control. Drivers may be more sensitive to the damping of the dynamic coupling during headway control, and perhaps would prefer phase margins that are closer to what they achieve manually. Because the ICC has the potential for much less time delay than the driver, neutrally damped phase margins can be achieved at a much higher bandwidth under automatic control conditions. Drivers should be tested over a range of crossover frequencies to determine the most desirable automatic control condition.

During emergency overtaking conditions the ICC should give the driver a distinctive haptic cue (e.g. a high deceleration pulse) that will stimulate emergency manual control action as rapidly as possible. To be distinctive, the haptic cue must stand out as much as possible from the ordinary automatic control behavior of the ICC. This suggests that the ordinary automatic control mode be as smooth and non aggressive as possible so that the emergency haptic cue is as distinctive as possible. Emergency haptic cue algorithms should be tested relative to different automatic control bandwidth conditions to find a desirable compromise between ordinary and emergency operating conditions. Test conditions will have to be designed that create the emergency conditions. We may be able to accomplish this within the current protocol used for the manual headway control experiment. Initially the ICC can be operated in conjunction with a lead vehicle following the velocity profiles described in this report. The subjects can be encouraged to follow at minimum headway times which should occasionally result in overtaking conditions that will exceed the ICC system deceleration authority limit. These tests can be conducted under manual and automatic head way control conditions to identify any improvements in braking response accruing to the ICC system.

There are two additional approaches that should be considered in the second year's research on ICC implementation. The first approach involves interactive driving simulation to look at driver/vehicle interaction issues associated with controls and displays, and driver expectations of ICC system functionality, particularly in safety related situations such as sensors not responding to slow and stopped vehicles. Display issues include visual and auditory indications of system function including authority limit exceedance. A second research approach involves computer simulation of driver/vehicle performance using the Ford REAMACS model to estimate ICC collision avoidance benefits. This model can be improved using data collected on the current project, then benefits estimated over a range of operational conditions.



## REFERENCES

- Allen, R.W. (1982), "Stability and Performance Analysis of Automobile Driver Steering Control," SAE Paper 820303, International Congress & Exposition, Detroit, MI.
- Bekey, G.A., Burnham, G.O. and Seo, J. (1977), "Control Theoretic Models of Human Drivers in Car Following," *Human Factors*, vol. 19, no. 4, pp. 399-413.
- Chandler, F.E., Herman, R., and Montroll, E.W. (1958), "Traffic Dynamics: Studies in Car Following," *Operations Research*, 6, pp. 165-184.
- Hart, S.G. and Staveland, L.E. (1988), "Development of NASA-TLX (Task Load Index): Results of empirical and theoretical research. In P.A. Hancock and N. Meshkati (Eds.), *Human Mental Workload* (pp. 139-183), Amsterdam: North-Holland.
- McRuer, D.T. and Krendal, E.S. (1974), "Mathematical Models of Human Pilot Behavior," AGARD-AG-188.
- Pipes, L.A. (1953), "An Operational Analysis of Traffic Dynamics," *Journal of Applied Physics*, vol. 24, pp. 271-281.
- Torf, AS. and Duckstein, L. (1966), "A Methodology for the Determination of Driver Perceptual Latency in Car Following," *Human Factors*, vol. 8, no. 5, pp. 441-447.

## APPENDIX A

# \_\_\_\_\_

### SUBJECT INFORMED CONSENT FORM

I, \_\_\_\_\_, agree to participate in a driving study.

I understand that:

1) The purpose of this study is to look at individual driving data while following another vehicle and to rate the usability of an electronic climate control system.

2) As a participant, I will drive a Ford Taurus on a test track while following a lead vehicle. I understand that the experiment I will be participating in will last about 30 minutes. Prior to beginning the experiment, I will be asked to complete a pre-drive questionnaire.

3) During the experiment, a ride-along test observer will be in the test vehicle with me. This observer will assist me in learning to use the climate control system. This observer will also give instructions for driving, ask me to use the climate control system, and ensure that no inadvertent safety risks are taken. At the conclusion of the experiment, I will be asked to complete a post-drive questionnaire regarding my impressions of using the climate control system.

4) While driving for this study, I will not be asked to perform any unsafe driving actions and agree to obey all traffic laws.

5) While driving, I will be subject to all risks normally present during driving. I am aware that accidents can happen at any time while driving.

6) The results of this study will provide guidance for the development of future vehicle systems. By participating in this study, I am lending my expertise and experience to support research regarding the future development of such systems. I understand that I will not be informed as to the results of this study.

7) Ford is gathering information on system use and driving. Ford is not testing me. My name will not be voluntarily released to anyone not working on the project. My name will not appear in any reports or papers written about the project. It is possible that, should I be involved in an accident during testing, Ford will have to release data on my driving in response to a court order.

The data gathered in this experiment will be treated with anonymity. Shortly after you have participated, your name will be separated from your data.

8) Ford employees will answer any questions that I may have about this study. The employee in charge of this testing is:

Steven J. Eckert  
Ford Motor Company  
19540 Allen Road  
Melvindale, MI 48122  
phone (313) 323-2249

9) My participation in this study is voluntary and I understand that I may withdraw from this testing at any time, for any reason, without penalty or loss of benefits to which I am entitled.

I certify that, to the best of my knowledge, I have no physical ailments or conditions which could either be further aggravated or adversely affected by participating in this test.

I, \_\_\_\_\_, HAVE READ AND UNDERSTOOD THE TERMS OF THIS AGREEMENT. I VOLUNTARILY CONSENT TO PARTICIPATE IN THIS STUDY.

SIGNATURE \_\_\_\_\_  
DATE \_\_\_\_\_  
WORK \_\_\_\_\_  
ADDRESS \_\_\_\_\_  
TELEPHONE \_\_\_\_\_  
FAX \_\_\_\_\_  
PROFS ID \_\_\_\_\_

**APPENDIX B**

Date \_\_\_\_\_ # \_\_\_\_\_

**Biographical Data Form**

**Name** \_\_\_\_\_

Job in Ford \_\_\_\_\_

Phone number \_\_\_\_\_

Year of birth \_\_\_\_\_

Vehicle \_\_\_\_\_

Typical route from home to work (main roads only)

\_\_\_\_\_  
\_\_\_\_\_

Corrective lenses \_\_\_\_\_

## APPENDIX C

### SUBJECT INSTRUCTIONS

Thanks for participating in this drive study. You'll be driving a total of 6 laps around the track. During the last 3 laps, we'll ask you to use various buttons on the climate control. During the study, we'd like you to drive around the track following the xxxxx car ahead of you. The car ahead may speed up or slow down while you are driving; please continue to follow it as if you were driving in traffic. When using the controls, please continue to follow the car ahead of you as if you were driving in traffic. At the end of the study, we'd like you to complete a brief questionnaire regarding the climate control buttons that you used while driving. Please let me know if you have any questions at any time during the study.

Before we begin, I should let you know that this study is being conducted as part of a joint project with Ford and the National Highway Traffic Safety Administration (NHTSA). Since it's part of government study, I need to ask you to read this sheet and review and sign this consent form. If you have any questions, please ask at anytime, and remember that you can stop participating in the study at any time.

HAND SUBJECT THE DOT FORM TO REVIEW & SIGN

I also need to obtain some information about you and your driving habits.

ASK THE QUESTIONS ON THE BIOGRAPHICAL DATA FORM

## **APPENDIX D**

### **DRIVER/VEHICLE PARAMETER IDENTIFICATION PROCEDURES**

#### **INTRODUCTION**

The data processing and analysis used in this report involves frequency domain procedures designed to identify transfer functions and model parameters for drivers, vehicles and the combined driver/vehicle system. These procedures start with time histories of key variables (e.g. throttle, speed, range) that define the basic human/machine system dynamic response. These time histories are then transformed using FFT (Fast Fourier Transform) procedures to give frequency domain transfer functions between key variables. The FFT procedures are the frequency domain equivalent of linear regression analysis procedures that define the relationship between a dependent variable and an independent variable in terms of correlated and uncorrelated components.

With FFT analysis the correlated response between independent and dependent time histories then defines a transfer function that expresses an input/output relationship (e.g. driver throttle response to changes in lead vehicle headway) between key system variables. Given a transfer function, parameter identification procedures can then be used to identify key system characteristics such as driver/vehicle time delay and gain in response to lead vehicle velocity changes.

#### **DATA ACQUISITION AND PROCESSING**

Measured time histories were recorded during experimental runs and converted to binary form including scaling constants to allow for maximum efficiency in processing and storage. The time histories were initially manually screened to locate regions of artifact free response, and to screen out segments containing drop outs in sensor response. This was particularly important regarding the range sensor data in both the test track and open highway experiments. The range signal would drop out if range became too large or a combination of lateral position and road curvature caused the lead target vehicle to exceed the limits of the sensor azimuth field of view.

Good sections of time history response were identified for further FFT processing. Additional preprocessing was carried out by applying taper windows to minimize transient artifacts associated with selecting data time windows where the time histories are abruptly started and stopped. The data were then processed by an advanced FFT routine that provided power spectra and transfer functions and coherence functions between selected variables. The coherence function is the equivalent of a linear correlation function, and defines what percentage of an output signal in a given frequency region is linearly correlated with an input signal. Typically the coherence values are used to select transfer function points that are reliable (high coherence) and reject unreliable measurements (low coherence).

Transfer function and coherence function data were plotted as indicated in the body of the report to highlight reliable transfer function data and to allow for simplified parameter identification. If it is assumed that the driver/vehicle system can be described by the simple gain and time delay model used by previous investigators, then these parameters can be easily identified from transfer function plots. The gain is identified from the amplitude plot, and the time delay is obtained from the phase plot. If more detailed model parameter sets are desired, then a formal parameter identification processing procedure must be used.

The parameter identification procedure used here allowed parametric transfer function models to be fit to transfer functions obtained from FFT procedures. The parameter fits were obtained by a program that adjusts parameter values to minimize a cost function composed of errors between the parametric model and the original FFT transfer function. Search routines (e.g. modified Newton-Raphson) are used to adjust model parameters until the cost function is minimized. Once a model/data fit has been obtained, the model can then be plotted in conjunction with the FFT data as indicated in the body of the report to display the results of the fitting process and illustrate the adequacy of the model fitting procedure.

## **DRIVER/VEHICLE TRANSFER FUNCTION AND MODEL PARAMETER DESCRIPTORS**

The data reduction procedures discussed above were employed to provide driver/vehicle parameters for the models discussed in Section C of the body of this report. The most basic data identified here were the crossover frequency and time delay of the driver/vehicle system:

**Gain and Crossover Frequency** - The crossover frequency or gain of the manual headway control system is a measure of the amplitude of driver response to a perceived change in lead vehicle headway. The crossover frequency is also a measure of the system bandwidth in terms of frequency response. This measure is analogous to the bandwidth of audio components, albeit of a much lower frequency. As noted here, crossover frequencies for headway control are down on the order of 0.2-0.4 radians/second (0.03-0.06 Hz). In comparison with steering control, where crossover frequencies are typically on the order of 2-4 radians/second (0.3-0.6 Hz), speed response is a factor of 10 times slower. This indicates the slow nature of the speed response of the driver/vehicle system, which is due to a combination of driver perceptual factors and the sluggishness of vehicle longitudinal response.

**Time Delay and Phase Margin** - The driver's time delay is associated with perceptual processing and neuromuscular actuation. The time delay is a measure of the average delay in the driver's throttle response to changes in lead vehicle headway. Measured time delays for speed control were found herein to be on the order of several seconds, while steering time delays are on the order of a few tenths of a second. The large speed control time delays are associated with the perceptual processing required to perceive changes in lead vehicle headway as previously identified by Torf and Duckstein (1966).

Phase margin is a measure of transfer function phase lag at the driver's crossover frequency. As detail in Section C of the body of the report, phase margin is a measure of the closed loop damping of the driver/vehicle control system. Low phase margins, say less than 45 degrees, imply an oscillatory response (i.e. a 'slinky' response in following a lead vehicle). High phase margins greater than say 60 degrees imply a well damped response. Time delay is derived from phase margin using the relationships derived in Section C of the main body of this report.